

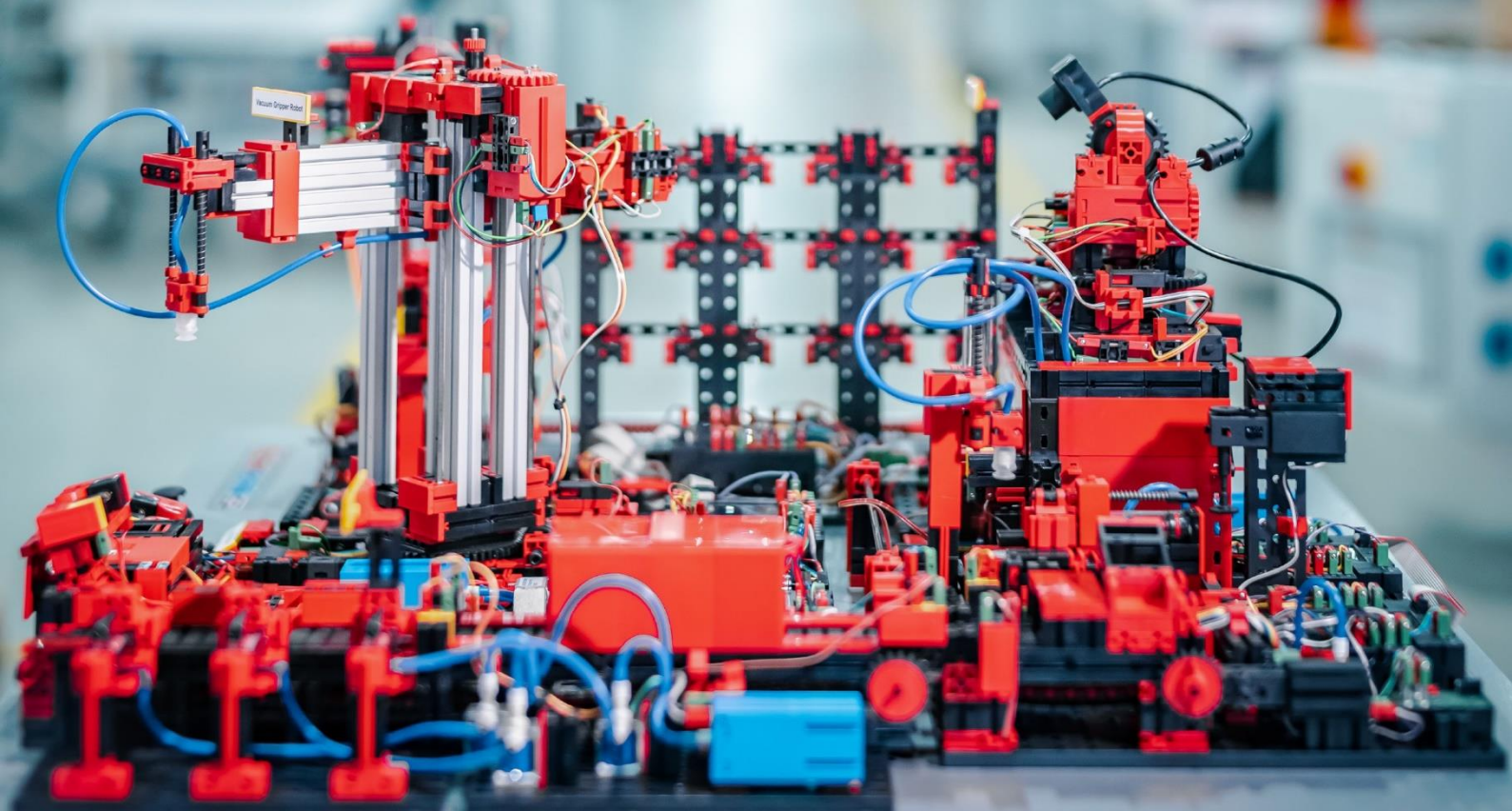

TRAINING FACTORY INDUSTRY 4.0

Activity booklet



Contents

| | |
|--|------|
| Introduction | p. 4 |
| Industry 4.0 New developments for Training Factory Industry 4.04.0 | p. 6 |
| Getting started | p. 8 |
| The individual factory components | p. 9 |
| Vacuum Suction Gripper 24V (VGR) | p. 9 |
| Automated high-bay warehouse 24V (HBW) | p.10 |
| Environmental sensor | p.10 |
| Multi-processing station with kiln 24V (MPO) | p.11 |
| Sorting line with colour recognition 24V (SLD) | p.12 |
| Environmental station with surveillance camera 24V (SSC) | p.14 |
| Surveillance camera in multi-processing station | p.15 |
| Environmental sensor and photo resistance in high-bay warehouse | p.15 |
| Input/output station with colour detection and NFC Reader 24V (SSC) | p.15 |
| TXT controller with adapter board | p.16 |
| Factory status display | p.16 |
| Block diagram of the factory | p.17 |
| Network structure of the factory | p.18 |
| Commissioning and adapting the SIMATIC controller CPU1512SP | p.19 |
| Commissioning and adapting the SIMATIC controller CPU1516F with ET200SP on PROFINET IRT | p.35 |
| Connecting the Training Factory Industry 4.04.0 to the Internet | p.55 |
| Connecting the nano Router TP-Link (WR802N) in WISP mode | p.55 |
| Training Factory Industry 4.0dashboard in the fischertechnik cloud | p.66 |
| User log-in | p.66 |
| Cloud connection | p.67 |
| Factory dashboard | p.69 |
| Dashboard camera | p.72 |
| Environmental station dashboard | p.73 |
| Operating the factory with the fischertechnik cloud | p.76 |
| Task 1 | p.77 |
| Task 2 | p.78 |
| Task 3 | p.81 |
| Task 4 | p.81 |
| Task 5 | p.82 |
| Task 6 | p.84 |
| Task 7 | p.85 |
| Task 8 | p.86 |

| | |
|---|-------|
| Training Factory Industry 4.0fischertechnik Node-RED dashboard | p.87 |
| Calibrating the system in the Training Factory Industry 4.0 fischertechnik Node-RED Dashboard | p.92 |
| Component description | p.98 |
| Factory module assignment plans | p.109 |
| Programming tasks | p.123 |
| Programming task 1 | p.124 |
| Programming task 2 | p.134 |
| Programming task 3 | p.136 |
| Programming task 4 | p.138 |
| Programming task 5 | p.140 |
| Programming task 6 | p.142 |
| Programming task 7 | p.145 |

Introduction



Digitisation in industrial production calls for stronger networking and smarter information at all levels of production. With fischertechnik Training Factory Industry 4.04.0, these digitisation activities can be simulated, learned and applied on a small scale before they are implemented on a large scale.

A highly flexible, modular, inexpensive and robust training and simulation model which is extremely easy to use.

The fischertechnik learning environment can be used to learn about and comprehend Industry 4.0 applications in vocational school and training applications, and can also be used for research, teaching and development at universities in companies and in IT departments. The simulation depicts the ordering process, the production process and the delivery process in digitised and networked process steps.

It consists of factory modules like storage and retrieval stations, vacuum suction grippers, high-bay warehouse, multi-processing station with kiln, a sorting section with colour detection, an environmental sensor and a pivoting camera.

After workpieces are ordered via the dashboard in the fischertechnik cloud, they go through the individual factory modules. The current status is shown in the fischertechnik cloud. The integrated environmental sensor reports values for temperature, humidity, air pressure and air quality. The camera sees the entire system through the vertical and horizontal pan range and can thus be used for web-based remote surveillance.

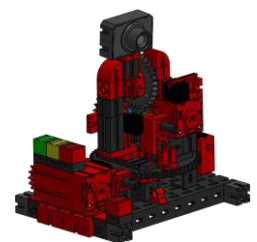
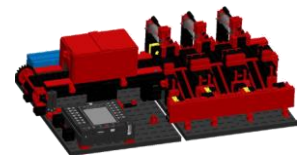
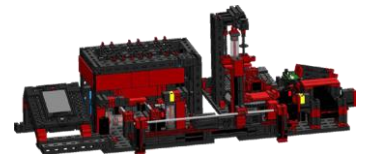
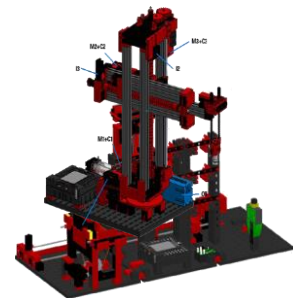
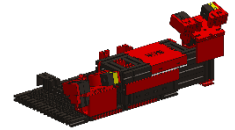

Individual workpieces are tracked using NFC (Near Field Communication): A unique identification number (ID) is assigned to each workpiece. This enables traceability and visibility of the current status of the workpieces in the machining process.



The Training Factory Industry 4.04.0 can be controlled by a SIMATIC S7-1500 programmable logic controller (PLC) made by SIEMENS (not included in the scope of delivery for the Training Factory Industry 4.04.0).

Note: Control systems from other manufacturers may also be used. Then, the source codes can be imported to create the programs, depending on the controller used. These are available at:

https://github.com/fischertechnik/plc_training_factory_24v/PLC_SCL_sources

A TXT controller serves as MQTT broker and interface to the fischertechnik cloud. MQTT (Message Queuing Telemetry Transport) is an open message protocol that enables the transmission of data in the form of messages between devices.



Communication between the PLC and TXT controller is carried out using an IoT gateway via OPC UA. OPC UA (OPC Unified Architecture) is a standard for exchanging data across different platforms.

Industry 4.0 New developments for Training Factory Industry 4.04.0



The popular, fully-automated fischertechnik factory simulation is the basis for developing Training Factory Industry 4.04.0. Here is a link to a video for anyone interested in the simulation, or anyone just getting started working with it. The video provides a good overview of how the system works:

https://youtu.be/BApxuYIsT_w

The vacuum suction gripper fits the stacker crane with workpieces. This stores the workpieces in the high bay, sorted by colour. Next, the workpieces are brought to the multi-processing station where they are processed. Then the machined workpieces are sorted by colour in the sorting line and transported to storage locations. From there, the vacuum suction gripper transports the workpieces back to the high-bay warehouse. This is a **never-ending, repetitive cycle.**

New additions to Training Factory Industry 4.04.0 include:

- Additional input/output station with quality control
- Sensor station with integrated camera and environmental sensor
- A SIEMENS-SPS SIMATIC S7-1500 as controller
(not included in the scope of delivery for the Training Factory Industry 4.04.0)
- Example programs written in standard language for SIMATIC S7-1500
- Connecting to the fischertechnik cloud
- A TXT controller as MQTT broker and interface to the fischertechnik cloud
- IoT gateway (Raspberry Pi) with Node-RED
- Using NFC/RFID to identify workpieces
- Integrated WiFi router
- Presenting and using data on a dashboard in the fischertechnik cloud
- Displaying data and calibrating the stations in a Node-RED dashboard
- Displaying the current system status via a traffic light

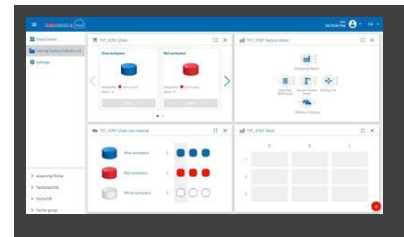
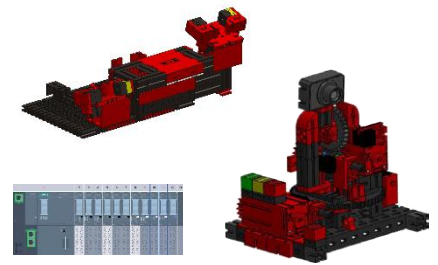

The individual innovations are explained in more detail in the following chapters.

Software for the SIEMENS PLC SIMATIC S7-1500

The SIMATIC S7-1500 is programmed using version 16 of the TIA portal and the programming language structured text (ST or SCL)

Software for TXT controller: C/C++ API programming interface

The software applications are written in C/C++ and are already loaded on the controller in the ready-to-start status. The corresponding C/C++ library and the API are published on Github:

https://github.com/fischertechnik/plc_training_factory_24v.

This library can be used to write customised C/C++ programs for the learning factory.

Software for the IoT gateway

A finished Node-RED application is already loaded onto the IoT gateway.

Node-RED is available here as open-source software from the OpenJS Foundation:

<https://nodered.org>.

First steps

After carefully unpacking the Training Factory Industry 4.04.0 and removing the transport lock, visually inspect for any transport components that have become loose or damaged. If necessary, put loose components back in the right place. Compare your model with the Training Factory Industry 4.04.0 comparison images, which are stored on the eLearning website. Make sure that all cables and hoses are connected. You can use the assignment diagrams to connect cables that are not connected correctly.



Connect the Training Factory Industry 4.0 adapter boards to the PLC. You can do so either using ribbon cables to the corresponding 34-pin ST1 connections, or via terminals.



Note: Further details on fitting the adapter boards are provided in the section **Factory module assignment plans**.

Complete the network connections between the PLC SIMATIC S7-1500, nano Router TP-link, IOT Gateway (Raspberry Pi) and, optionally, with the Browser PC.

Note: See also the section **Factory system network structure**

Once any errors have been corrected, plug the PLC power supply into the mains power. It is best to use an outlet strip with mains power switch. This allows you to switch the system on and off.



Switch it on to test the PLC and TXT controller (ON/OFF). If everything works, the display should go on, the PLC and TXT controller should start up and the indicator lights should be illuminated.

Finally, load the high-bay warehouse with the 9 empty black containers included in the delivery.



The individual factory components

This chapter introduces the individual factory components and briefly explains their function.

What are robots?

The Association of German Engineers (VDI) defines industrial robots in VDI Guideline 2860 as follows:

“Industrial robots are universally applicable multi-axis motion machines whose movements with respect to movement sequence and paths or angles are freely programmable and, if necessary, sensor-guided (i.e., without mechanical or human intervention). They can be equipped with grippers, tools or other means of production and can perform handling and/or manufacturing tasks”.

Vacuum Suction Gripper 24V (VGR)

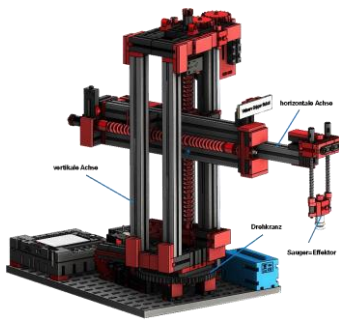

The 3-axis robot with vacuum suction gripper positions workpieces quickly and precisely in three-dimensional space. Workspace: X-axis 270°, Y-axis (forward/backward) 140 mm, Z-axis (up/down) 120 mm. The 3D vacuum suction gripper, therefore, is an industrial robot that can be used for handling tasks. The vacuum gripper picks up workpieces and move them within a working space. This

working space is based on the robot’s kinematic structure and defines the area that the robot effector can work within.

In the case of the vacuum suction pad, the vacuum unit is the effector and the working space corresponds to a hollow cylinder whose vertical axis coincides with the robot’s axis rotation.

The geometric shape of the working space is based on the kinematic structure, which is shown in the illustration and which is composed of a rotary and two translational axes.

The typical work order for this kind of robot can be subdivided into the following work steps

- Positioning of the suction gripper on the workpiece
- Mounting the workpiece
- Transporting the workpiece within the work area
- Depositing the workpiece

Positioning the suction gripper or transporting the workpiece can be defined as a point-to-point or a continuous path. Controlling the individual axes takes place sequentially and/or in parallel, influenced by workspace obstacles that exist in the workspace or by predefined intermediate points. The vacuum suction gripper is controlled using a 3/2-way solenoid valve and two coupled pneumatic cylinders to create vacuum pressure.

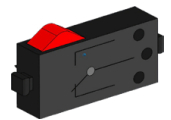

Buttons

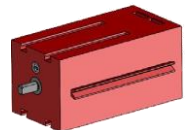

Encoder engine



Compressor

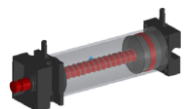

Cylinder

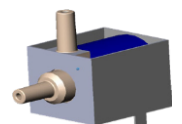

3/2-way solenoid valve

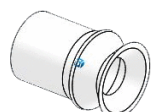

Automated high-bay warehouse 24V (HBW)

What is a high-bay warehouse?

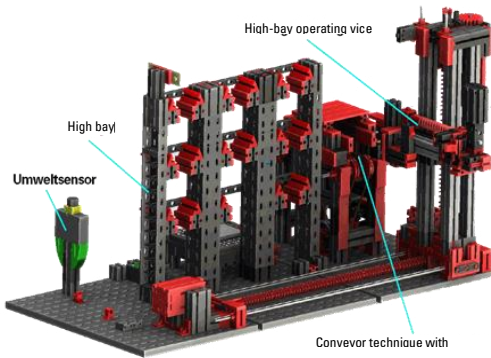

A high-bay warehouse is a storage area that saves space and allows computer-aided storage and retrieval of goods. In most cases, high-bay warehouses are designed as pallet-rack warehouses. This standardisation ensures a high degree of automation and allows for connection to an ERP system (enterprise resource planning). High-bay warehouses include

Very efficient use of space and a large required investment. Stacker cranes store and retrieve goods that are then moved into an alley, which is located between two rows of high-bay shelves. This area is part of the pre-zone where the goods are identified. Goods are provided and delivered to the stacker crane via conveyor technology, such as chain conveyors, roller conveyors or vertical conveyors. No one should be present in this area if the storage and retrieval machines are automated. In the case of the automated high bay, a conveyor belt transports the goods.

Environment sensor

The environmental sensor was built on the base plate of the high-bay warehouse for space reasons. The electrical connections, however, are on the TXT controller.



Photo-transistor

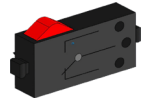

Buttons

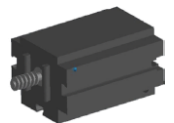

Mini motor

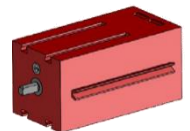

Encoder engine



Multi-processing station with kiln 24V (MPO)

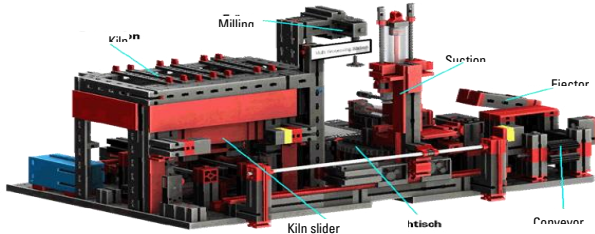

The workpiece automatically passes through several stations that simulate different processes in the multi-processing station with kiln. Different conveyor technologies, such as a conveyor belt, turntable and a vacuum suction gripper are used. The machining process starts with the kiln. To initiate processing, the workpiece is placed on the oven pusher. In doing so, the photoelectric barrier is interrupted, which causes the kiln door to open and then retract the kiln slider. At the same time, the vacuum suction gripper, which brings the workpiece to the turntable after the firing process, is requested. Following the firing process, the kiln gate is re-opened and the oven slide re-extended. The positioned vacuum suction gripper that is already in place picks the workpiece up, transports it to the turntable and places it there. The turntable positions the workpiece under the miller, lingers there for the machining time and then moves the workpiece to the pneumatically-actuated ejector. The ejector pushes the workpiece onto the conveyor belt, which conveys the workpiece to a photoelectric barrier and then to the sorting system. Passing through the photoelectric barrier causes the turntable to return to its original position and for the conveyor belt to stop with a time delay.

The program runs in parallel. The system is divided into the three units: Kiln, vacuum suction gripper, and turntable. The individual processes communicate with one another, ensuring, for instance, that no collisions occur.

For example, the kiln triggers the movement of the vacuum suction gripper at two points in the program sequence, which ensures that the vacuum suction gripper is not only in the right spot at the right time, but also that it does not reach into the void. Likewise, the turntable is activated after the workpiece has been deposited by the vacuum suction gripper.

The workpiece automatically passes through several stations that simulate different processes in the multi-processing station with kiln. Different conveyor technologies, such as a conveyor belt,

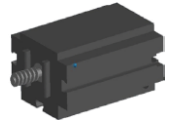

Mini motor



Photo-transistor

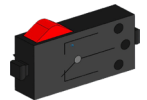

Buttons



Vacuum



Compressor

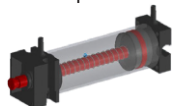

Cylinder

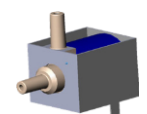

3/2-way solenoid valve

Sorting line with colour recognition 24V (SLD)

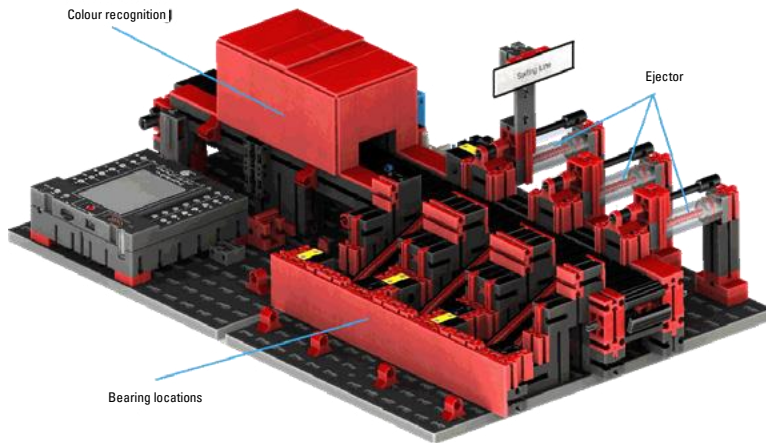

The sorting line with colour recognition is used to automatically separate workpieces of different colours. Components with the same geometry but of different colours are fed to the conveyor belt via a colour sensor

and then separated by colour. A motor drives the conveyor belt and an impulse sensor measures the conveying path. Pneumatic cylinders, which are assigned to the corresponding storage locations and operated by solenoid valves, eject the workpieces. Several photoelectric barriers control the flow of the workpieces and whether there are workpieces in the storage locations.

Colour detection is carried out using an optical colour sensor that emits light, and determines the colour of a surface based on reflections from the surface. Thus, the colour sensor is strictly a reflection sensor that indicates how well a surface reflects light. The measured value of the sensor is therefore not proportional to the wavelength of the measured colour and assigning colour coordinates or colour spaces (for example RGB or CMYK) is not possible. In addition to an object's colour, ambient light, the object's surface and the distance of the object from the sensor affect the quality of the reflection. This is why it is critical that the colour sensor is protected from ambient light and the surfaces of the objects are comparable.

It is also important that the sensor is installed perpendicular to the surface of the object. Distinguishing among the coloured workpieces is done in thresholds that compare the measured values of the individual colours against each other. Since the value ranges of different colour sensors differ, these limit values must be adjusted.

Both the process and the conveyor belt start if a workpiece is placed on the conveyor belt and the workpiece interrupts the photoelectric barrier. For a colour to be recognised, the workpiece passes through a darkened lock in which a colour sensor is installed. During this time interval, the minimum value of the measured colour values is determined and assigned to the workpiece. In the time required for the workpiece to pass the colour sensor, the previous minimum value is compared with the current measured value, which may then replace the earlier measured value.

The photoelectric barrier, which is located before the first ejection point, controls whether



Compressor

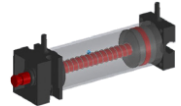

Cylinder

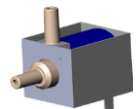

3/2-way solenoid valve

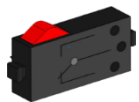

Buttons



Photo-transistor



Colour sensor

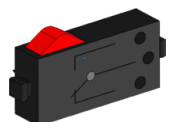

Mini motor

a workpiece is ejected. Depending on the detected colour value, the corresponding pneumatic cylinder is time-delayed triggered after the workpiece interrupts photoelectric barrier. Next, the pulse button is activated. It registers the rotation of the gear that drives the conveyor. Unlike a time-based delay, this approach is robust in withstanding conveyor speed fluctuations. The ejected workpieces are fed through three slides to the respective depositories.

The storage locations are equipped with photocells that recognize whether the storage location is filled or not. However, the photocell cannot determine how many workpieces are in a storage location.

Environmental station with surveillance camera 24V (SSC)

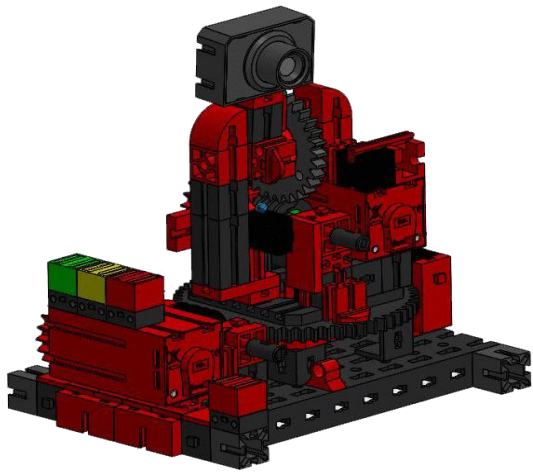

The environmental station with surveillance camera is used to record measured values within the factory. The mobile camera station is located on the multi-processing station and visually monitors the system.

The new environmental sensor and a photo resistor allow the air temperature, humidity, air pressure, air quality and brightness to be measured. The values are displayed graphically.



Photo-resistor, environmental sensor

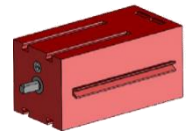

Encoder engine

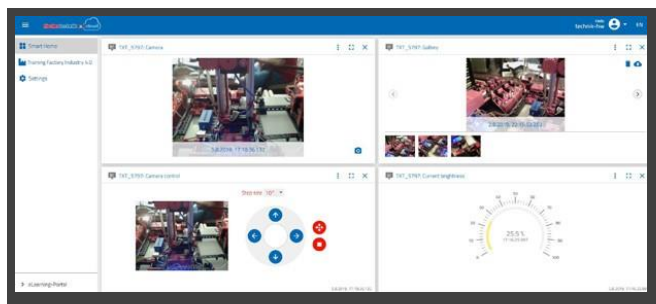

The camera can be rotated using a virtual joystick and it can be tilted to monitor the factory. The images are also displayed on the monitor screen.

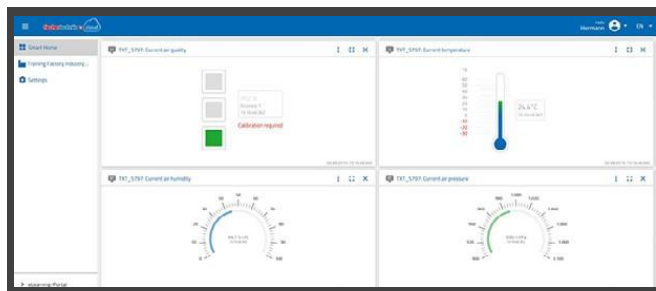

The different sensor data is controlled on an ongoing basis on a user interface, the "Dashboard". The movement axes of the camera can also be controlled here. A LED display indicates when the set limit values have been exceeded. The red LED always lights up when an image from the camera is being transferred to the cloud.

Surveillance camera in the multi-processing station

p

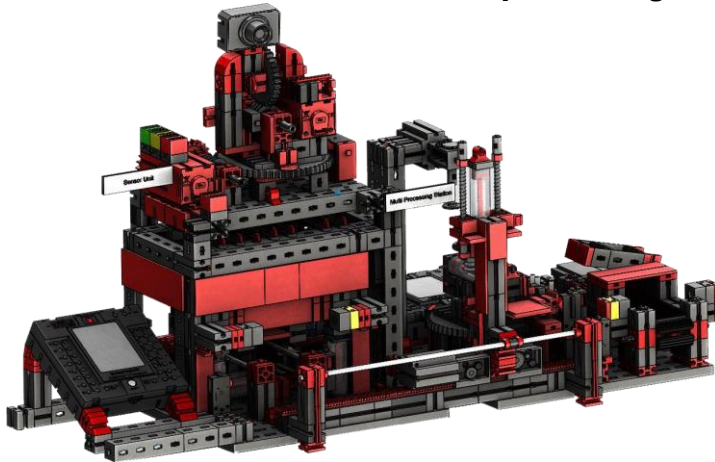

The two “multi-processing centre and surveillance camera” modules have been combined into one overall module at the factory. The advantage here is that the camera is at the highest point in the factory and can thus monitor the entire system. The surveillance camera also has a visual indicator (red light). Blinking indicates images are being recorded.

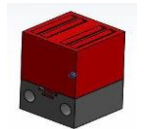

Control lamp red

Environmental sensor and photo resistance in high-bay warehouse

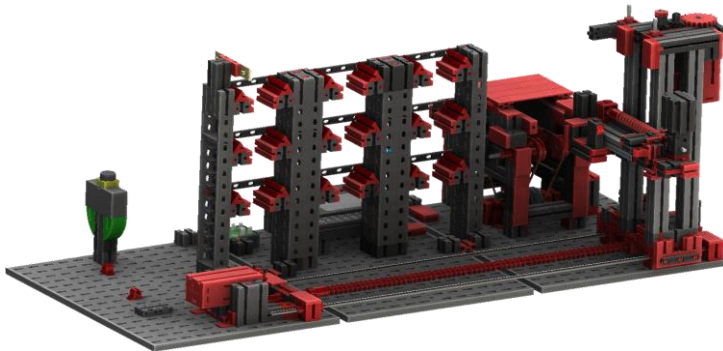

The environmental sensor and photo-resistor are located on the high-bay module. Both of them are connected to the TXT controller,

Input/output station with colour detection and NFC Reader 24V (DPS)

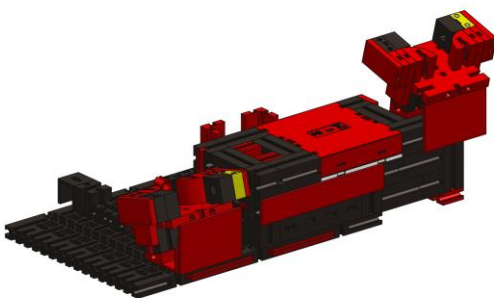

The in- and output station consists of a total of 3 work areas:

- The input and output unit
- Colour recognition
- The NFC reader

The photoelectric barrier at the input station detects whether a workpiece to be stored in it is present. If this is the case, the information is sent to the continuing program (vacuum suction gripper picks up the workpiece).

Before the workpiece is processed any further, the colour sensor determines of the workpiece colour.

After colour detection, different data are assigned to the workpiece. To detect a workpiece's colour, the vacuum suction gripper places the workpiece on the NFC reader.

First, all data in the memory is deleted and the workpiece marked as raw.

The reader then writes data relevant to the workpiece on the **NFC tag NTAG213** in the workpiece.

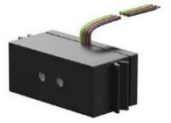

Colour sensor



Photo-transistor

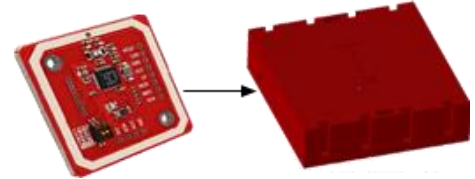

The NFC reader

Important note: An NFC tag has a unique ID. This cannot be changed.

If one or more workpieces are ordered, they will be sent to the output area after various tasks have been carried out. Previously, additional production data for each workpiece could be stored in the available memory on the NFC tag.

TXT controller with adapter board

The TXT controller and an adapter board to connect the environmental sensor and photo resistor are also located on the input / output station. The camera is also connected here via a USB interface.



Adapter board



TXT controller

Factory status display

Three LEDs indicate factory status.

- Green** means all stations are waiting.
- Yellow** means that at least one station is active.
- Red** means an error that must be acknowledged on the dashboard in the cloud for the Training Factory Industry 4.0 to continue.



Status display

Block diagram of the factory

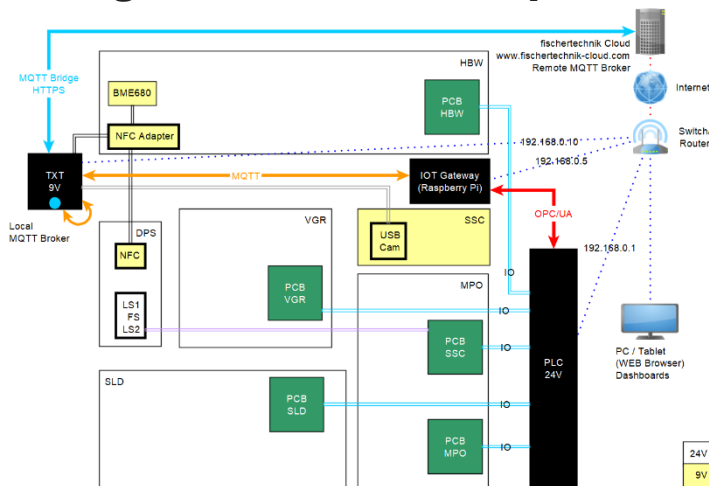

The block diagram shows you how the individual factory components communicate with each other and how the system is integrated with the Internet and the fischertechnik cloud. The block diagram also shows which information the user can retrieve via his PC, tablet or smartphone.

In the Training Factory Industry 4.04.0 24V, three different controllers communicate with one another, and are connected to one another via a Switch/Router.

- PLC (process control of the model, PLC program)
- IoT gateway (Node-RED environment as adapter between OPC/UA and MQTT, dashboard to control the model)
- TXT controller (fischertechnik sensors and connection to the fischertechnik cloud)

The PLC (not included in the scope of delivery) contains process control for the entire Learning Factory.

Since the MQTT interface in the PLC controller is not a standard interface, an additional IoT-Gateway (Raspberry Pi) with a Node-RED environment serves as an adapter to the MQTT interface. The PLC acts as a server, providing the data required to the IoT Gateway via the OPC/UA standard interface in the local network. The IoT Gateway then forwards the messages to the TXT controller.

The TXT controller serves as a gateway to the fischertechnik cloud <https://www.fischertechnik-cloud.com>.

In addition, the components camera, RFID/NFC reader, environmental sensor, BME680 and a brightness sensor are connected here and deliver data to the cloud.

Users can access the dashboard for the Node-RED application in the IoT gateway via a web browser.

Network structure of the factory

The following image represents the network structure and the standard IP addresses used:

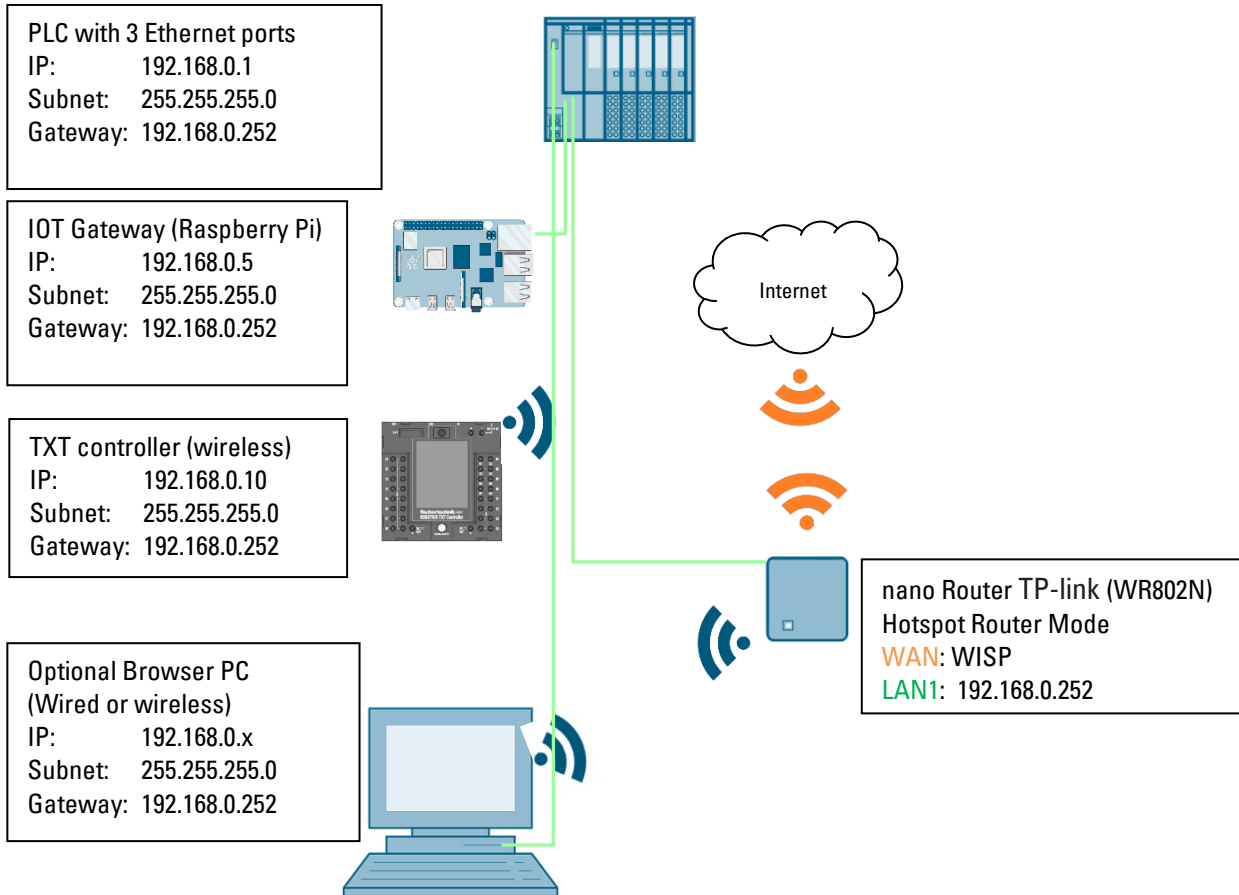

The Training Factory Industry 4.0 can be connected to wireless WiFi via a nano router TP link (WR802N) in WISP mode (hotspot router mode) to a wireless WAN. The Ethernet interface of the nano router must have an IP address of: 192.168.0.252 and is connected to the PLC (IP: 192.168.0.1). The IOT gateway must have IP: 192.168.0.5, and is also connected to the PLC.

DHCP is activated on the nano router, ensuring that the TXT controller is always supplied with the same IP address 192.168.0.10. Details on settings for the nano router are provided in the section Connecting Training Factory Industry 4.04.0

NTP time synchronisation can also be completed via the Internet NVP server. Remote maintenance is not possible.

Commissioning and adapting the SIMATIC controller CPU1512SP

The next few pages show how to connect the programmable logic controller (PLC) SIMATIC S7-1500 to the CPU 1512SP and how to load the program solution for complete factory operation.

This program solution is available as archive **LearningFactory_4_0_24V_V02.zap16** for the TIA Portal V16, and is the standard solution for the Training Factory Industry 4.04.0. However, the solution can also be adapted very easily. For example, it can be adapted to different configurations with different CPUs in the SIMATIC ET200SP series, or with different ET200SP input/output modules.

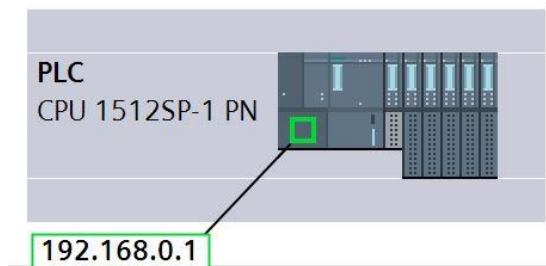

The assemblies used in the standard configuration are shown here:

| Modul | Steckplatz | E-Adresse | A-Adresse | Typ | Artikel-Nr. |
|---------|------------|-----------|-----------|---------------------|---------------------|
| ▶ PLC | 1 | | | CPU 1512SP-1 PN | 6ES7 512-1DK01-0AB0 |
| DO1+2 | 2 | | 1...2 | DQ 16x24VDC/0.5A ST | 6ES7 132-6BH01-0BA0 |
| DO3+4 | 3 | | 3...4 | DQ 16x24VDC/0.5A ST | 6ES7 132-6BH01-0BA0 |
| DO5+6 | 4 | | 5...6 | DQ 16x24VDC/0.5A ST | 6ES7 132-6BH01-0BA0 |
| DO7-14 | 5 | | 7...14 | DQ 4x24VDC/2A HS | 6ES7 132-6BD20-0DA0 |
| DO15-22 | 6 | | 15...22 | DQ 4x24VDC/2A HS | 6ES7 132-6BD20-0DA0 |
| DO23-30 | 7 | | 23...30 | DQ 4x24VDC/2A HS | 6ES7 132-6BD20-0DA0 |
| DI1+2 | 8 | 1...2 | | DI 16x24VDC ST | 6ES7 131-6BH01-0BA0 |
| DI3+4 | 9 | 3...4 | | DI 16x24VDC ST | 6ES7 131-6BH01-0BA0 |
| DI5 | 10 | 5 | | DI 8x24VDC HS | 6ES7 131-6BF00-0DA0 |
| DI6 | 11 | 6 | | DI 8x24VDC HS | 6ES7 131-6BF00-0DA0 |
| AI7-10 | 12 | 7...10 | | AI 2xU ST | 6ES7 134-6FB00-0BA1 |
| End | 13 | | | Servermodul | 6ES7 193-6PA00-0AA0 |

The program solutions are available at:

https://github.com/fischertechnik/plc_training_factory_24v/PLC_S7_1500_exercises

Note:

This section describes an example of commissioning for a SIEMENS SIMATIC S7-1500 controller with CPU1512SP. If a different controller is used, then other software tools must be used to create, and load the programs, and to operate the Training Factory Industry 4.04.0.

The source codes can be imported to create the programs, depending on the controller used. These are available at:

https://github.com/fischertechnik/plc_training_factory_24v/PLC_SCL_sources

Structure and operation of the CPU 1512SP-1 PN

Here is an overview of the elements of the CPU 1512SP-1 PN with bus adapter

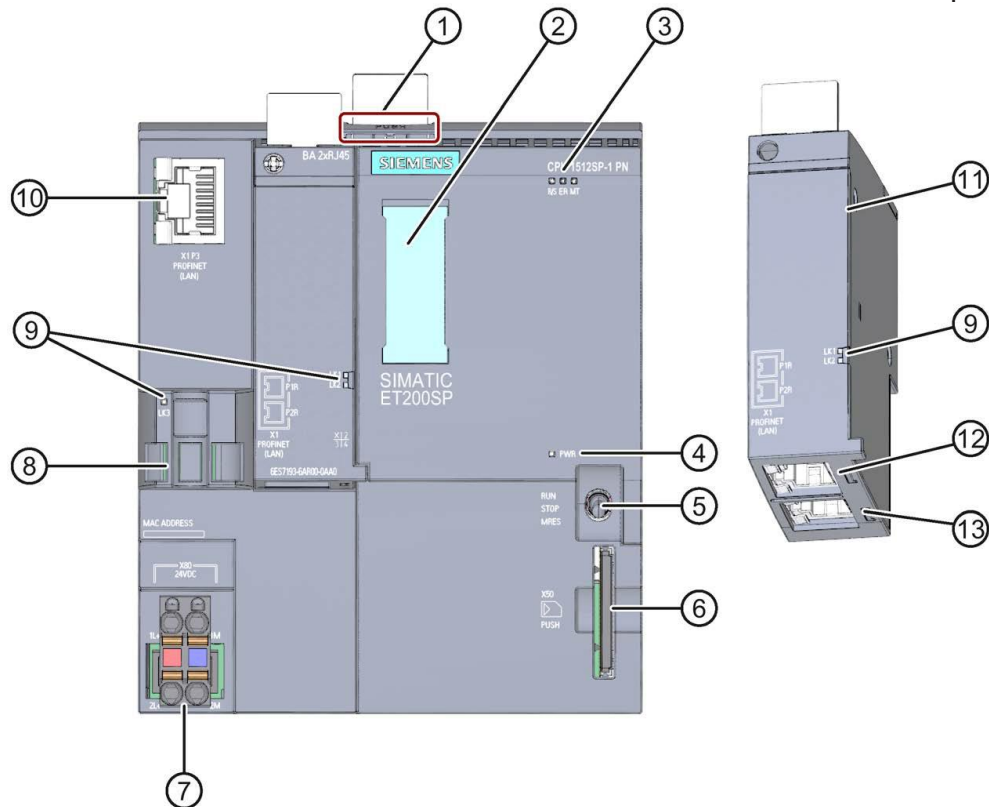

- ① Profile rail unlocking mechanism
- ② Label strips
- ③ LEDs for status and error indicators
- ④ LED for displaying supply voltage
- ⑤ Operating mode switch
- ⑥ Slot for the SIMATIC Memory Card
- ⑦ Connection for supply voltage (included in the scope of delivery)
- ⑧ Cable mount and attachment for port P3 of the PROFINET interface
- ⑨ LEDs as status indicators on the PROFINET interface to ports P1, P2 and P3
- ⑩ Port P3 of the PROFINET interface: RJ45 port on the CPU
- ⑪ Individual view of the bus adapter
- ⑫ Port P1 R of the PROFINET interface: RJ45 port to bus adapter BA 2xRJ45
- ⑬ Port P2 R of the PROFINET interface: RJ45 port to bus adapter BA 2xRJ45

Status and error indicators

The CPU 1512SP-1 PN and Bus-Adapter BA 2xRJ45 are equipped with the following diagnostic LEDs:

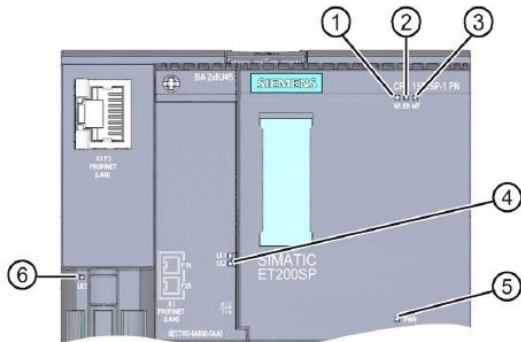

- ① RUN/STOP LED (yellow/green LED)
- ② ERROR LED (red LED)
- ③ MAINT LED (yellow LED)
- ④ LINK RX/TX-LED for the ports X1 P1 and X1 P2 (green LEDs on bus adapter)
- ⑤ POWER LED (green LED)
- ⑥ LINK RX/TX-LED for port X1 P3 (green LED on CPU)

SIMATIC Memory Card

A SIMATIC Micro Memory Card is used as the storage module for the CPUs. It is a specially pre-formatted memory card which is compatible with the Windows file system.

The MMC must be inserted to operate the CPU, since the CPUs do not have an integrated load memory for the programs. A common SD card reader is required to read/write the SIMATIC Memory Card with a laptop/PC. It can be used, for instance, to copy files directly to the SIMATIC Memory Card using Windows Explorer, or delete all program data.

Note: We recommend only inserting or removing the SIMATIC Memory Card into/from the CPU when it is powered down.

Operating mode switch

The operating mode switch can be used to set the current CPU operating mode. The operating mode switch is a toggle switch with 3 settings:

| Setting | Meaning | Explanation |
|---------|----------------|------------------------------------|
| RUN | RUN operating | The CPU processes the user program |
| STOP | STOP operating | The CPU processes the user program |
| MRES | Memory reset | Setting to reset the CPU |

STEP 7 Professional programming software in the TIA portal

The programming tool STEP 7 Professional is used to program and load the SPSen SIMATIC S7-1500. Program solutions for the Training Factory Industry 4.04.0 have been created with version V16 of STEP 7 Professional in the TIA Portal.

Further details are provided in the SIEMENS handbooks at:

<http://support.automation.siemens.com>.

Resetting the controller and setting the IP address

Before you can load program solutions to the SIMATIC S7-1500, you should reset it to default settings and set the IP address of the CPU 1512SP.

The following steps can be used to reset the CPU 1512SP to default settings.

- First, switch off the power supply to the controller and then remove the SIMATIC Micro Memory Card inserted in the CPU 1512SP.
- To delete all program data from the SIMATIC Micro Memory Card in the CPU, you can simply insert the SIMATIC Memory Card into a common SD card reader and delete data on the card using Windows Explorer.

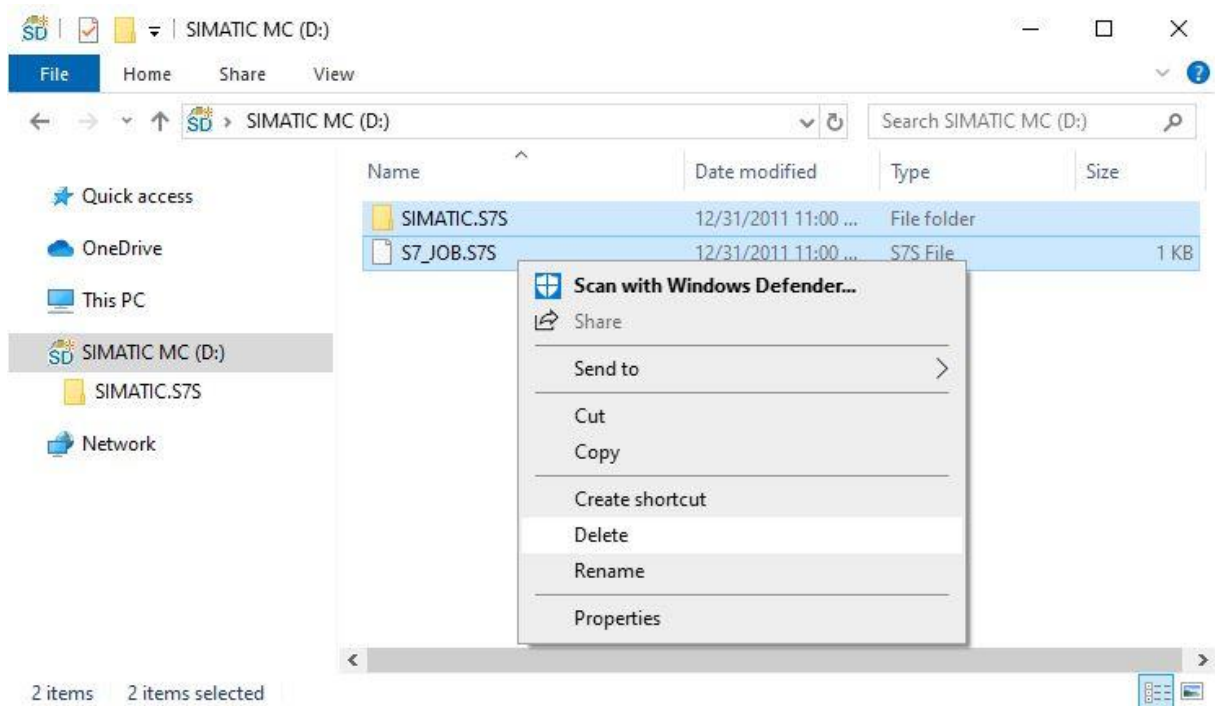

- Then, insert the SIMATIC Memory Card back into the CPU 1512SP and switch on the power supply to the controller.

Note: We recommend only inserting or removing the SIMATIC Memory Card into/from the CPU when it is powered down. Otherwise, it may be damaged.

Note: You should not format the SIMATIC Memory Card, just delete the data.

To be able to program a SIMATIC S7-1500 controller from a laptop/PC from the CPU, you will need a TCP/IP connection.

It is important for the IP addresses of the two devices to match, to ensure the computer and SIMATIC S7-1500 can communicate with one another via TCP/IP.

First, we will show you how to set the IP address of a computer using a Windows 10 operating system.

→ Mark the network symbol below in the task bar  and then click → **Network settings**.

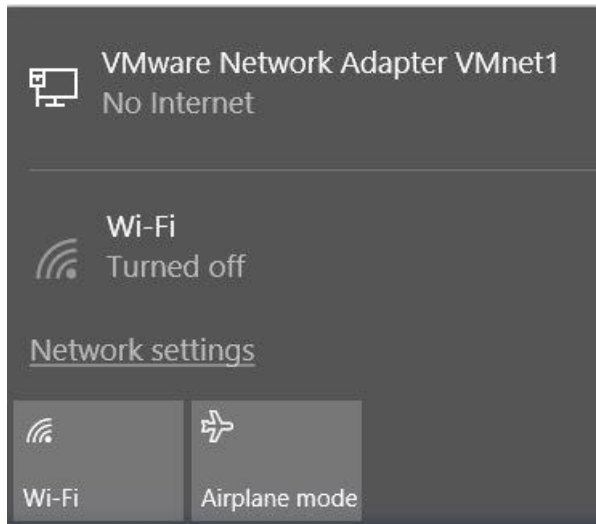

→ In the network settings window that opens, click → **Ethernet** and then click → **Change adapter options**.

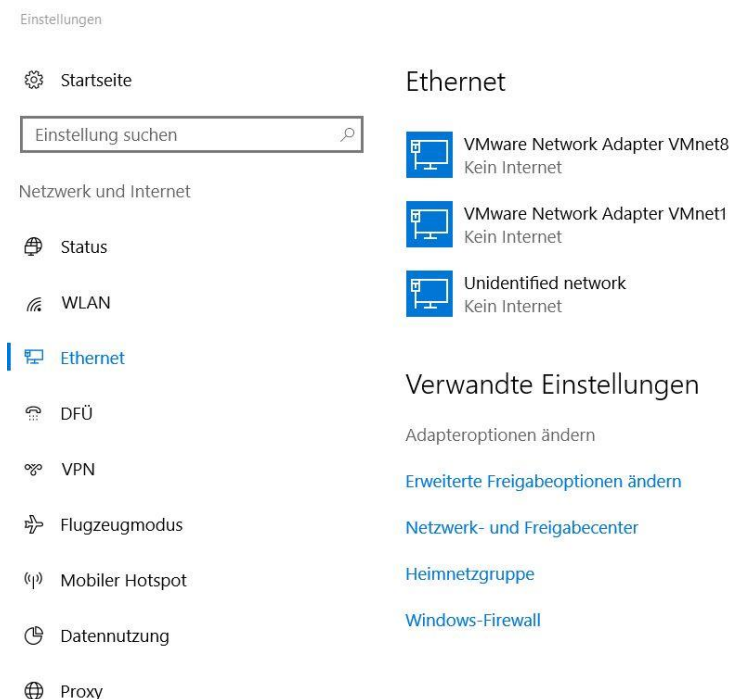

→ Select the desired → **LAN connection** you want use to connect the controller, then click → **Properties**.

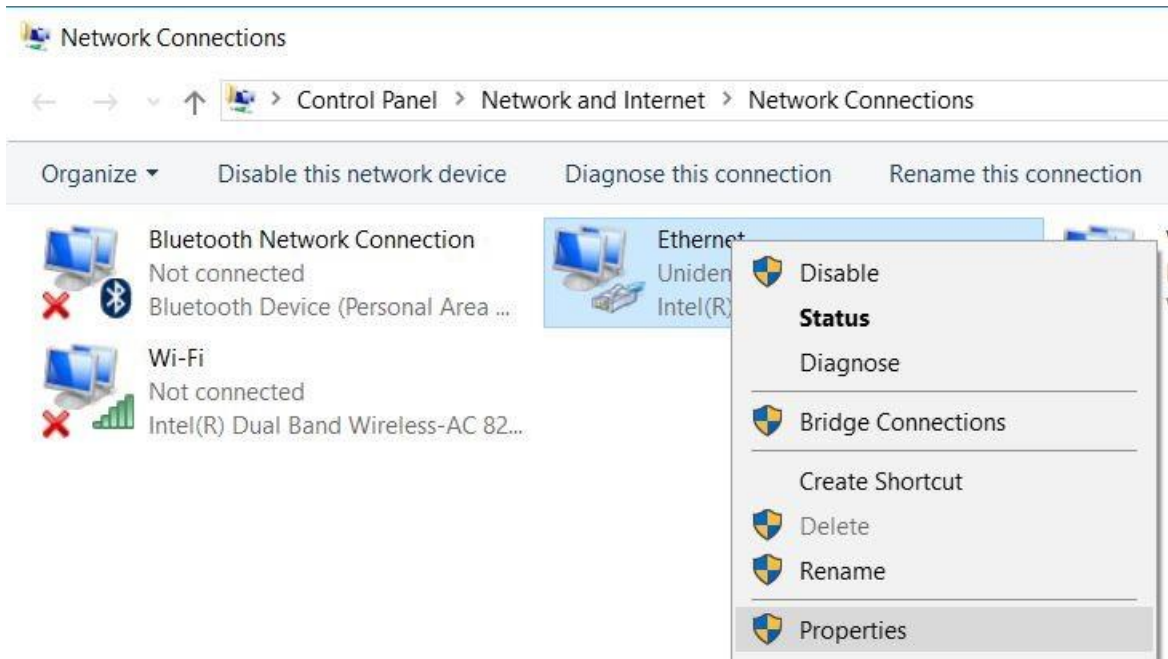

→ Now, select the → **Properties** for → **internet protocol Version 4 (TCP/IPv4)**.

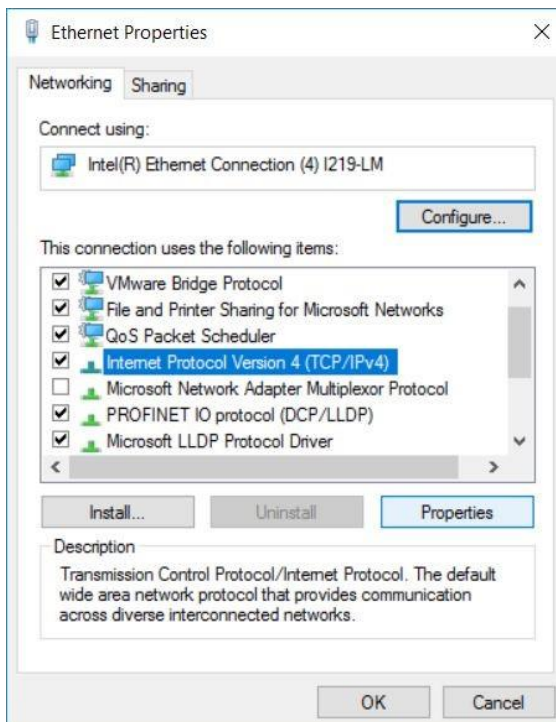

- Now you can use the following IP address, for instance → **IP address: 192.168.0.99** and enter the following → **subnet mask 255.255.255.0**. Then accept the settings by pressing → **OK**.

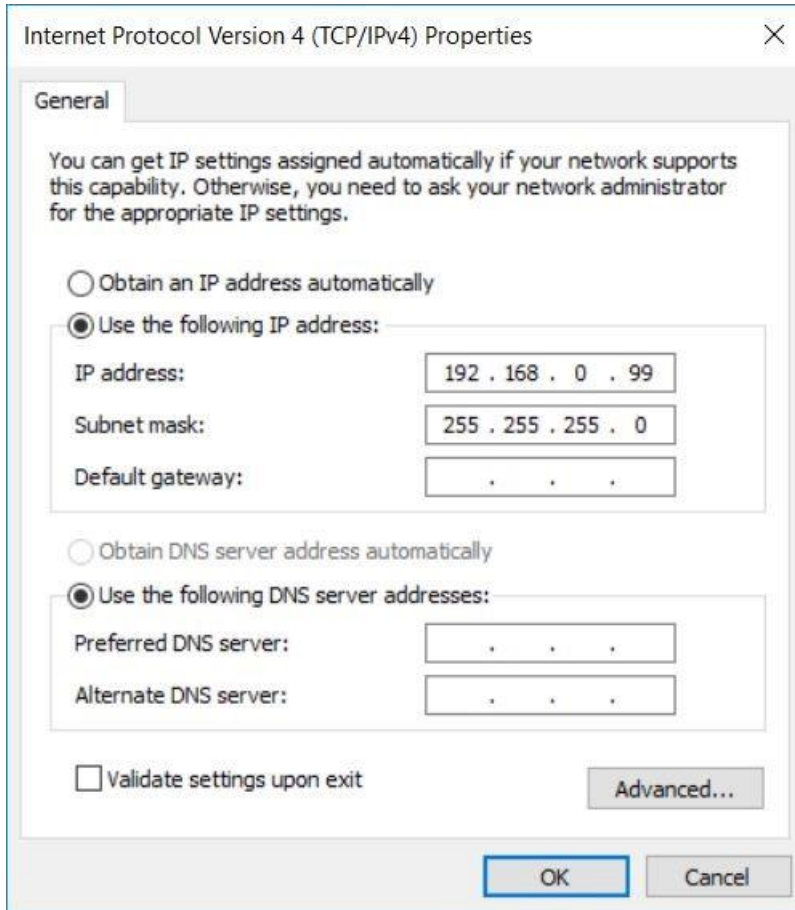

Now, you can assign the IP address to the CPU1512SP as shown in the following steps.

- Connect your laptop/PC directly to one of the three Ethernet interfaces on the CPU1512SP and switch on the power supply to the controller.
- Now, start the Totally Integrated Automation Portal by double clicking on it. (→ **TIA Portal V16**)



→ Select → **Online&Diagnostics** and then open the → **Project view**.

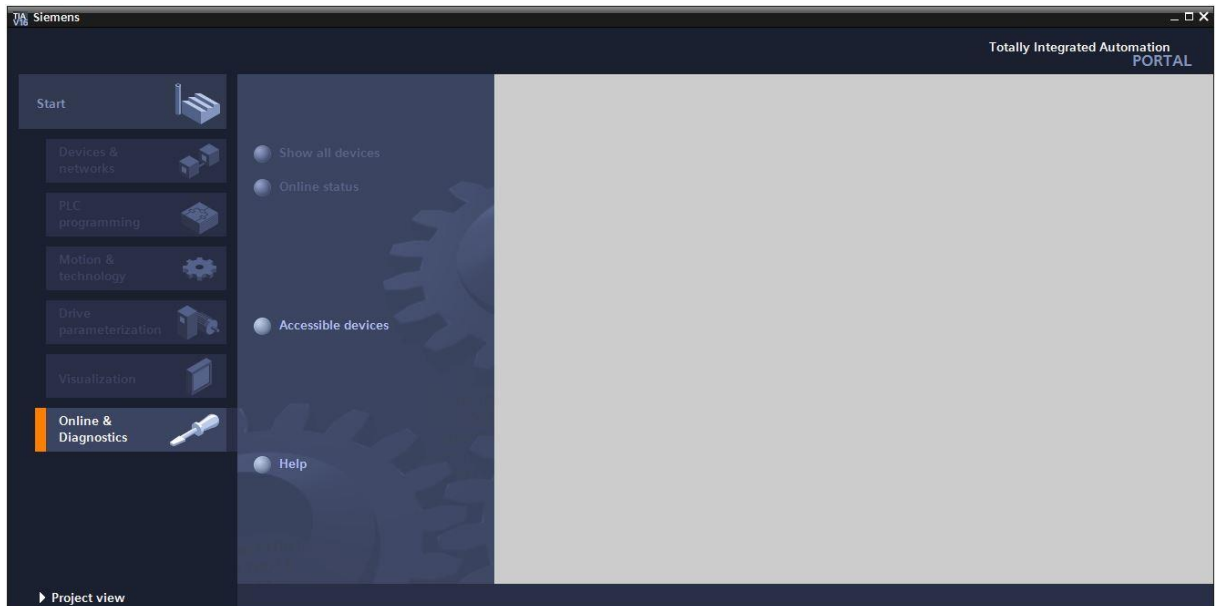

→ In the project navigation, select the previously set network card under → **Online access**. When you click → **Update available devices**, you will see the IP address (if already set) or the MAC address (if the IP address has not yet been assigned) for the connected SIMATIC S7-1500. Here, select → **Online&Diagnostics**.

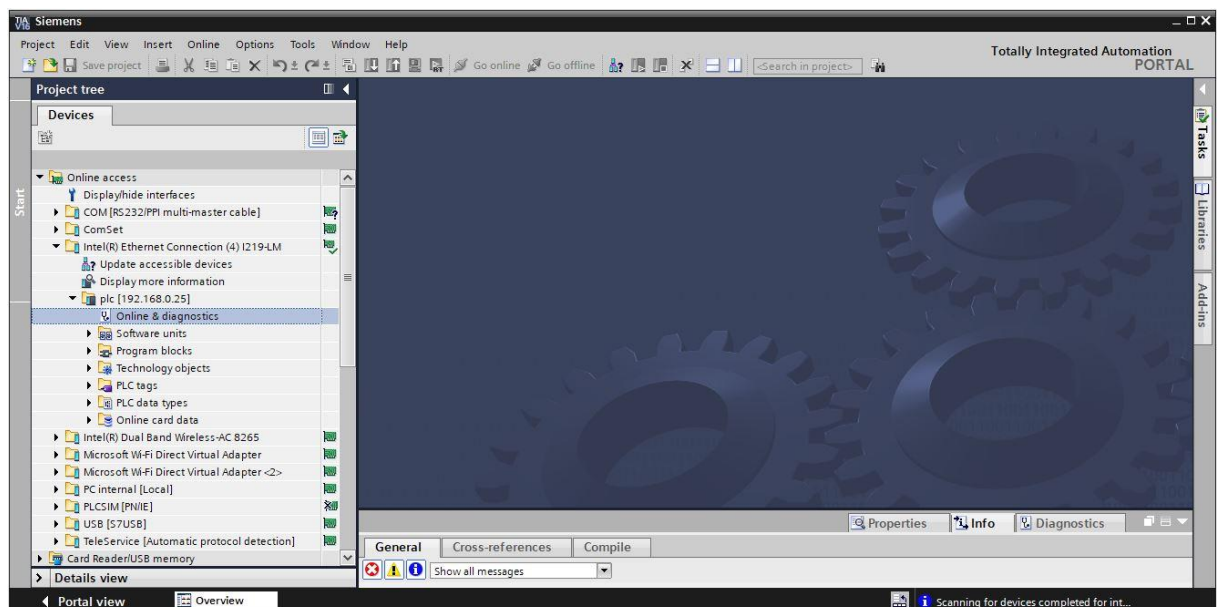

→ You will find → **Assign IP address** under → **Functions**. Here, enter the following IP address, for instance: → **IP address: 192.168.0.1** → **Subnet mask 255.255.255.0**. Now, click → **Assign IP address** and your SIMATIC S7-1500 will be assigned this new address.

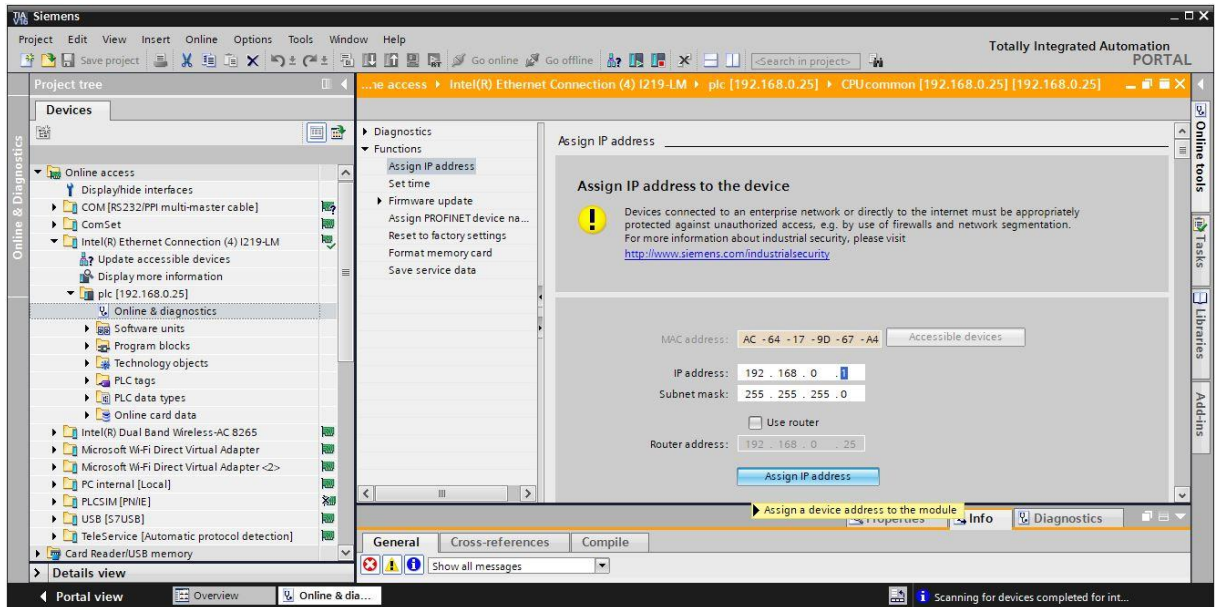

→ The → **Info** → **General** window provides messages on the status of address assignment.

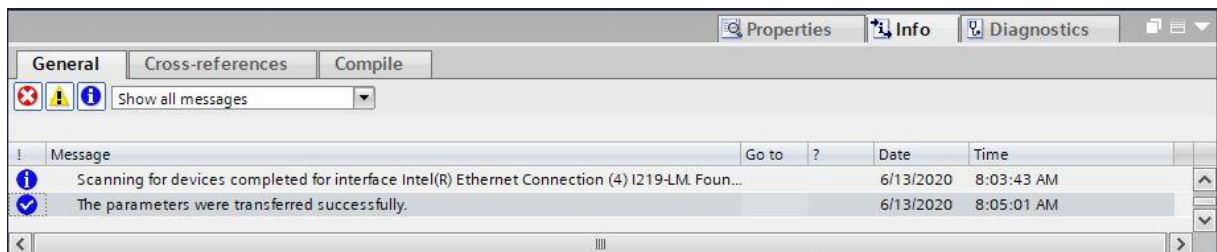

Open the program solutions for the Training Factory Industry 4.04.0

Open the program solutions for the Training Factory Industry 4.04.0 using the following steps.

→ In the menu of the TIA portal, select → **Project** → **Open** and then → **Search**.

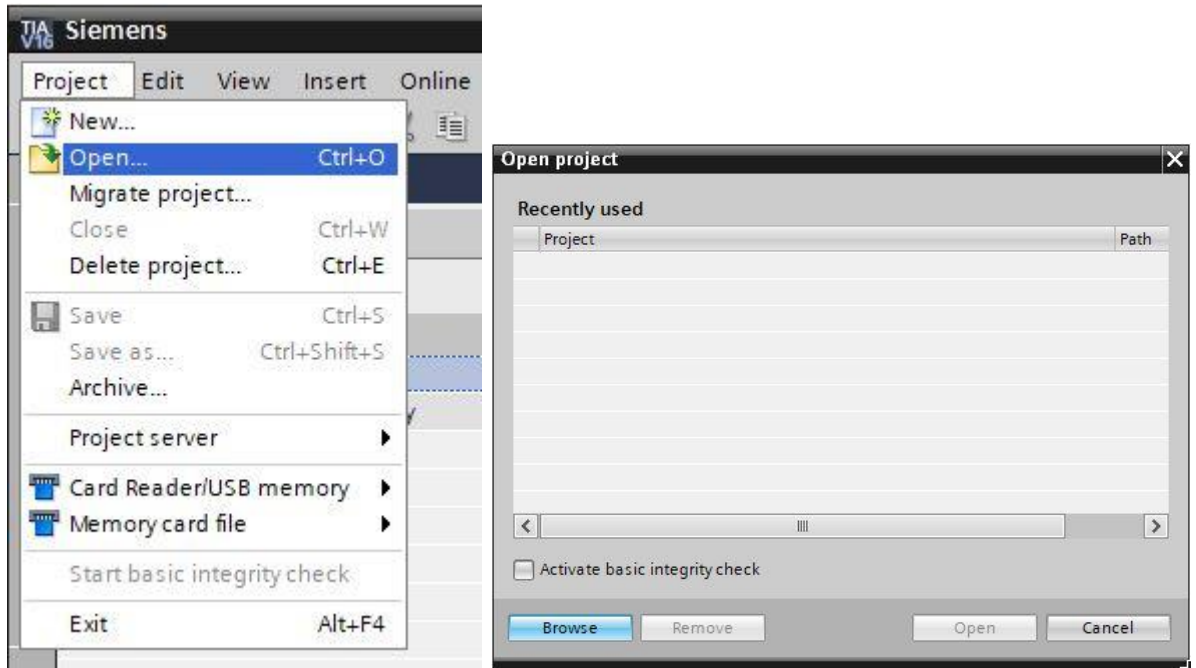

→ Then, click the compressed V16 project → **LearningFactory_4_0_24V** and select a target path on your computer to unpack the project there.

| | | | |
|---|------------------|---|----------|
|  LearningFactory_4_0_24V_V02 | 13.06.2020 08:45 | Siemens TIA Portal V16 compressed project | 2.966 KB |
|---|------------------|---|----------|

Note: The program solutions are available at:
https://github.com/fischertechnik/plc_training_factory_24v/PLC_S7_1500_exercises

Adapting the hardware configuration

The project is now open and will be displayed in the project navigation at left.

If your hardware components differ from those in the program solutions, these components must be adjusted in the TIA portal.

→ To do so, first open the → **Device configuration.**

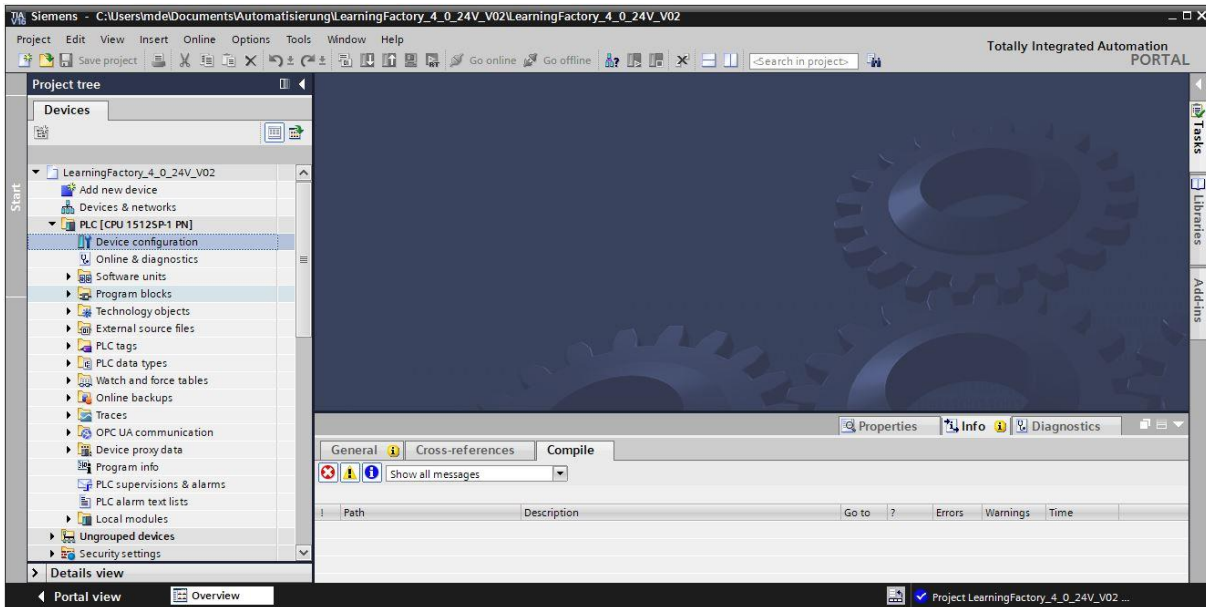

→ Mark one of the different components and then click → **Exchange device.**

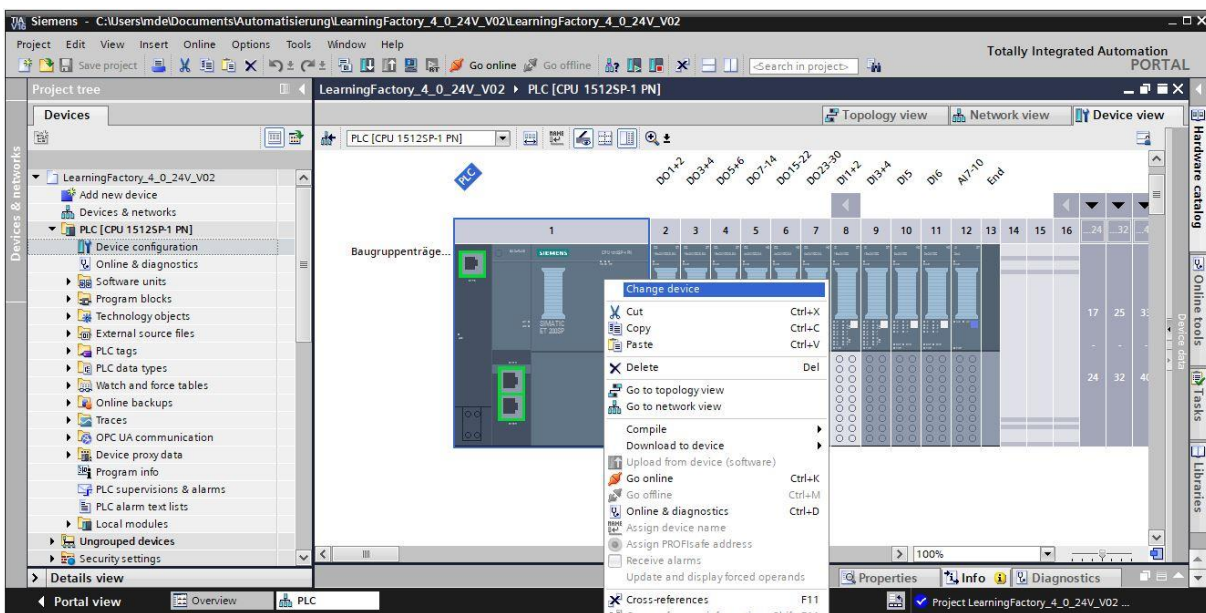

→ You will then see a dialogue where you can select from compatible devices.

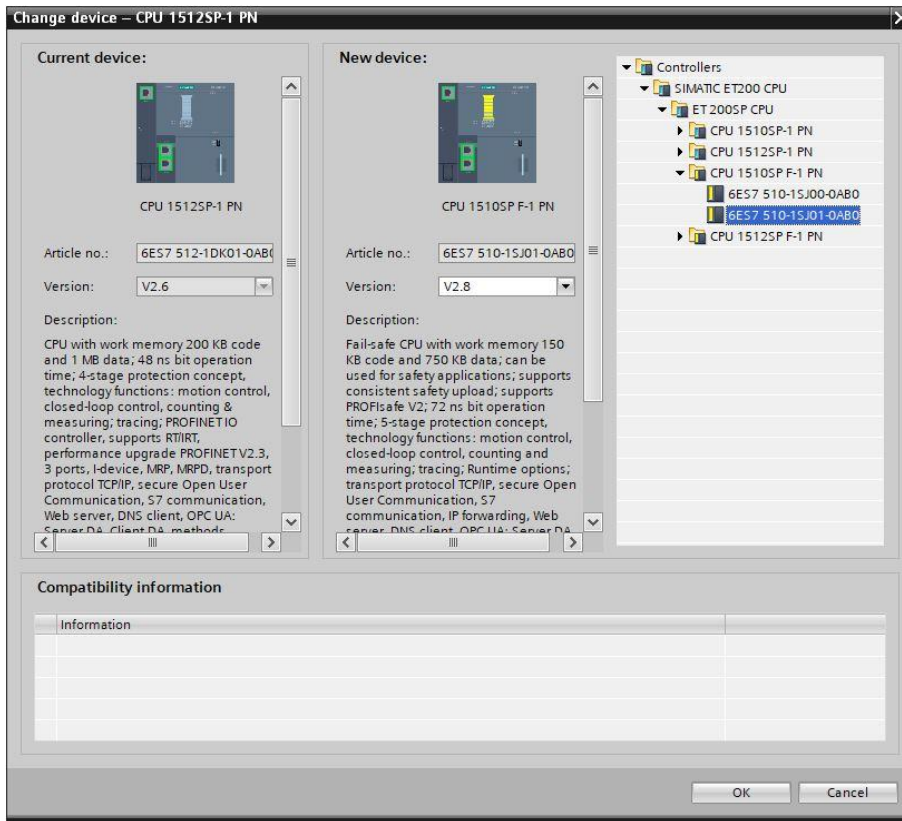

You must select the correct BaseUnit for the signal modules:

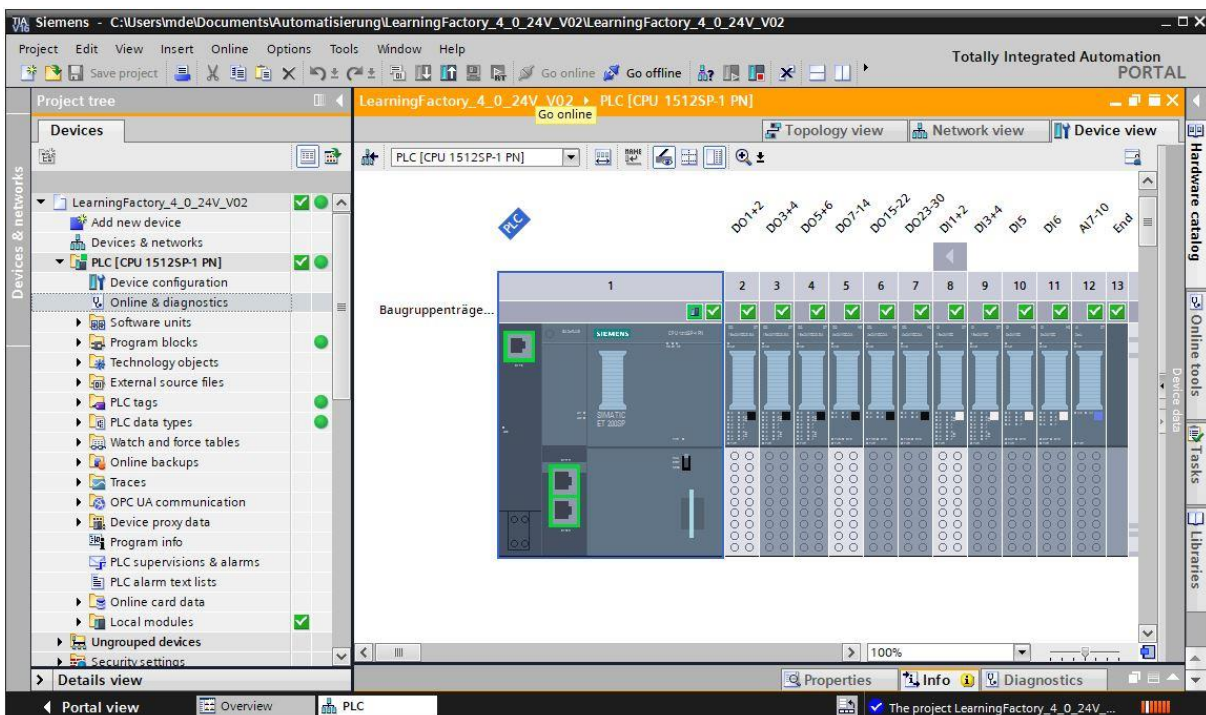

- Use potential group for the left module (dark BaseUnit)
- Facilitate new potential group (light BaseUnit)

→ You can change these settings under → **Properties** → **General** → **Potential group**.



Load the control program to the CPU1512SP

The following steps can be used to load the CPU 1512SP.

- Before you continue, you should click the →  **Save project** button to save your project.
- To load your entire CPU, including hardware configuration and program solutions, to the device, mark the → PLC [CPU1512SP-1 PN] folder and click the →  **Load to device** symbol.

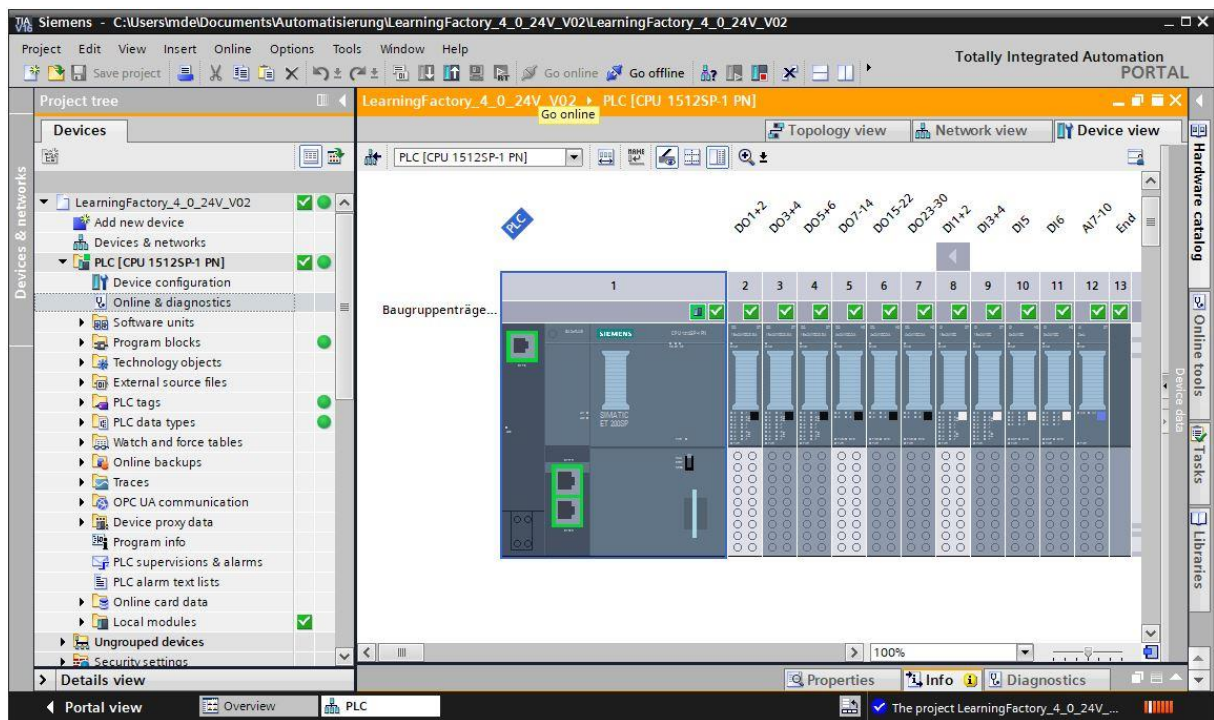

→ The Manager will open for configuring connection properties (expanded loading). First, select the correct interface. This involves three steps.

- **Type of PG/PC interface** → PN/IE

- **PG/PC interface** → here, for instance.: Intel(R) Ethernet Connection ...

- **Connection with interface/subnet** → Directly to port ,1 X1'

Then, activate the field → **Display all compatible devices**, and start the search for devices on the network by clicking the → **Start search** button.

If your CPU is displayed in the list, select it and start loading.

(Load → CPU 1512SP-1 PN→)

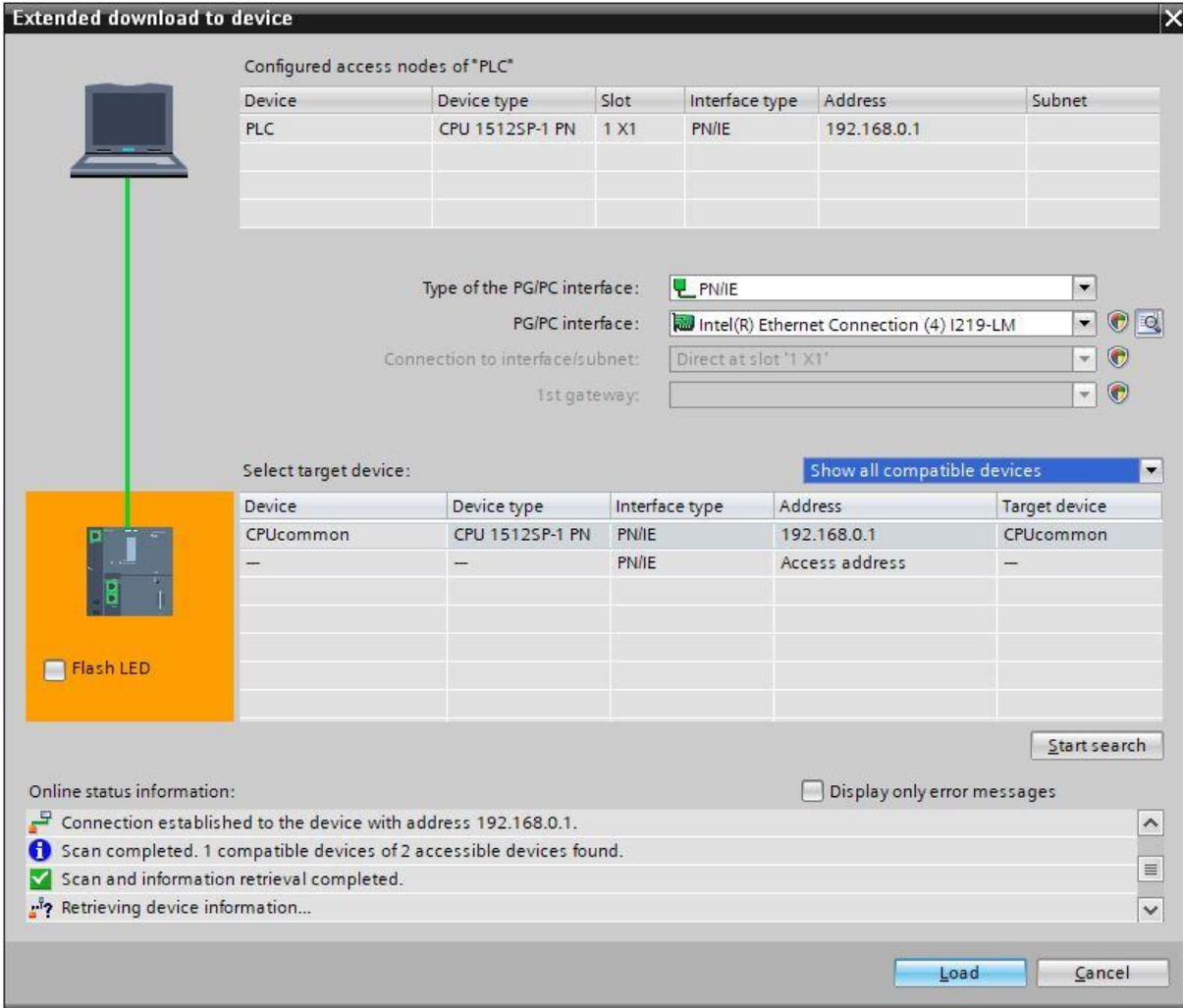

Extended download to device

Configured access nodes of *PLC*

| Device | Device type | Slot | Interface type | Address | Subnet |
|--------|-----------------|------|----------------|-------------|--------|
| PLC | CPU 1512SP-1 PN | 1 X1 | PN/IE | 192.168.0.1 | |

Type of the PG/PC interface:

PG/PC interface:

Connection to interface/subnet:

1st gateway:

Select target device:

| Device | Device type | Interface type | Address | Target device |
|-----------|-----------------|----------------|----------------|---------------|
| CPUcommon | CPU 1512SP-1 PN | PN/IE | 192.168.0.1 | CPUcommon |
| -- | -- | PN/IE | Access address | -- |

Online status information: Display only error messages

- Connection established to the device with address 192.168.0.1.
- Scan completed. 1 compatible devices of 2 accessible devices found.
- Scan and information retrieval completed.
- Retrieving device information...

→ First, you will see a preview with information on the loading process, data security, etc... Continue with → **loading**.

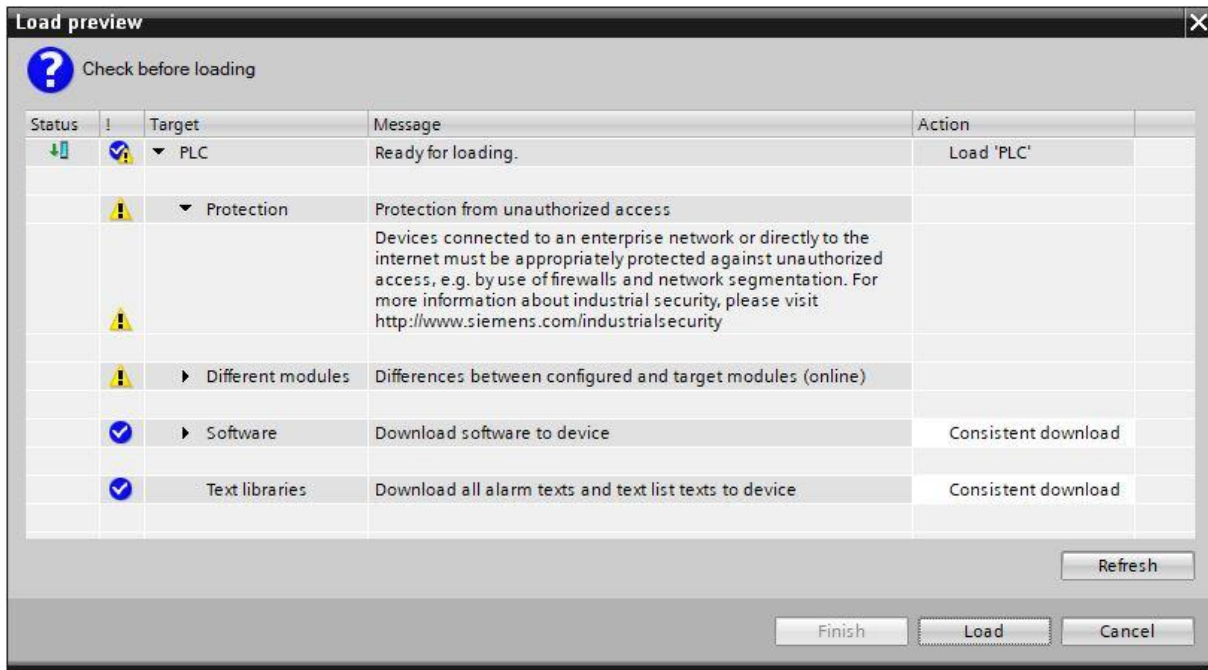

→ Now, select the option → **Start assembly** before completing the loading process with → **Complete**.

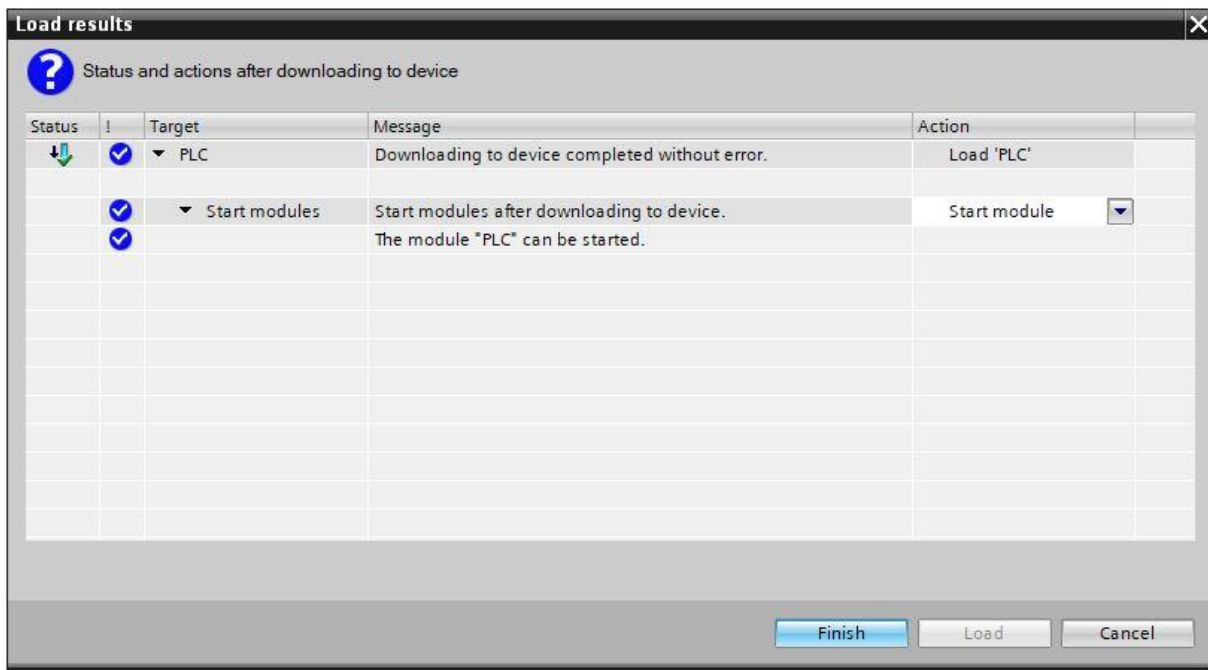

Finally, you can check online to ensure the configuration was loaded correctly. Then, set the time in the CPU if the set NTP server is not available for automatic time synchronisation.

→ Mark the CPU → **PLC[CPU 1512SP-1 PN]** and select → **Connect online**.

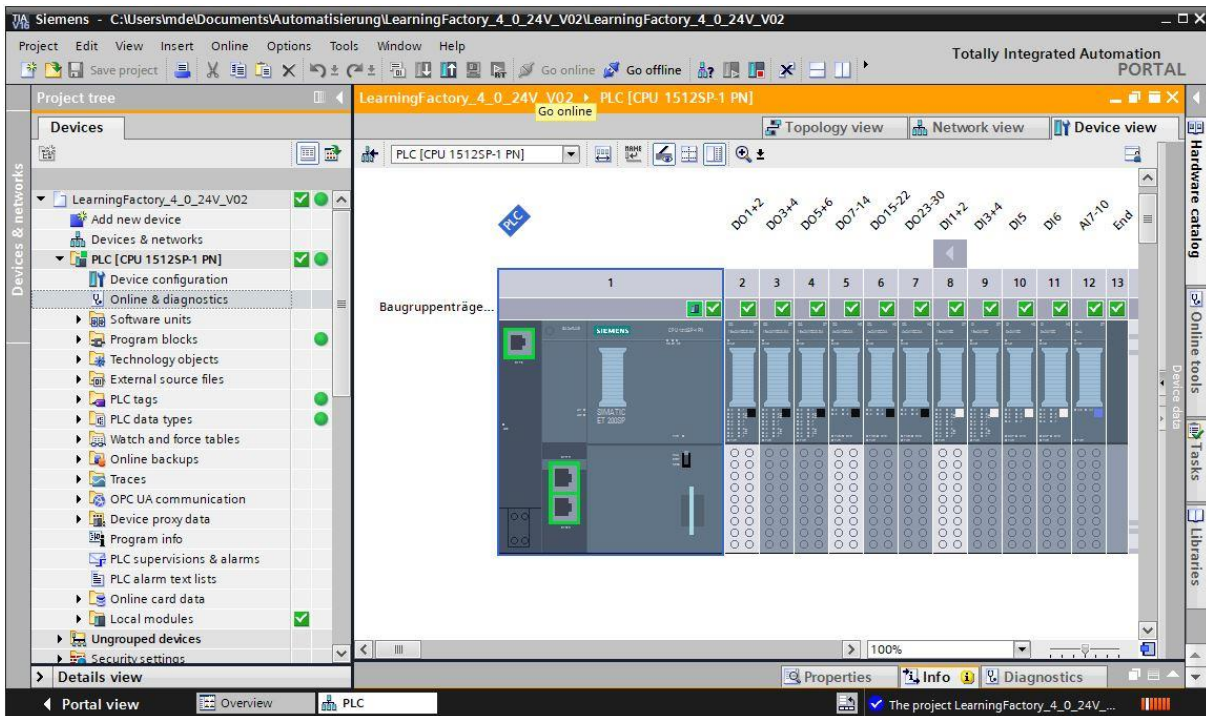

Note: The symbol should be green here if there are no errors.

→ To set the time, open → **Online & Diagnostics**, then select → **Set time** under → **Functions** and then → **Accept**, to adopt the time from your laptop/PC.

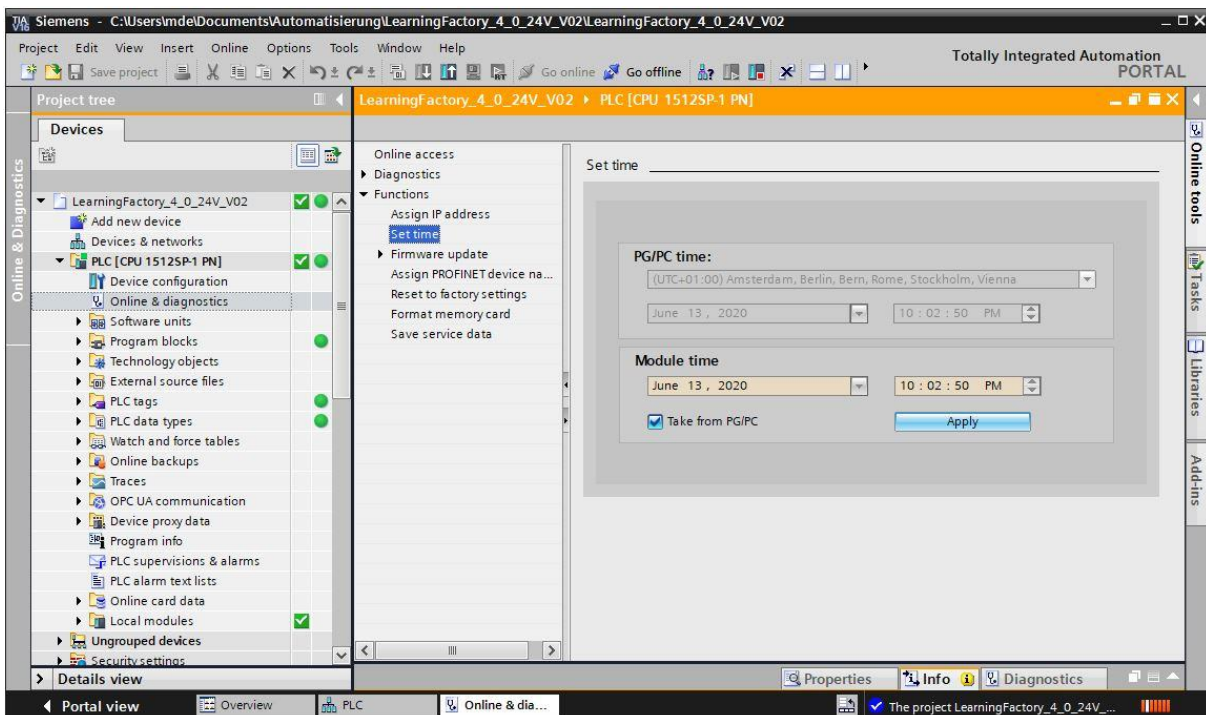

Commissioning and adjusting the SIMATIC controller CPU1516F with ET200SP on PROFINET IRT

The next few pages show how to connect the programmable logic controller (PLC) SIMATIC S7-1500 to the CPU 1516F-3 PN/DP and how to load the program solution for complete factory operation. This solution includes a decentralised connection of system signals to an ET200SP, which communicates with the CPU via PROFINET IRT (Isochrones Realtime). This section also describes commissioning of this ET200SP.

This program solution is available as archive **LearningFactory_4_0_24V_PROFINET_V02.zap16** for the TIA Portal V16, and is an alternative solution for the Training Factory Industry 4.04.0.

However, the solution can also be adapted very easily. for example, it can be adapted to different configurations with different CPUs in the SIMATIC S7-1500 series, or with different ET200SP input/output modules.

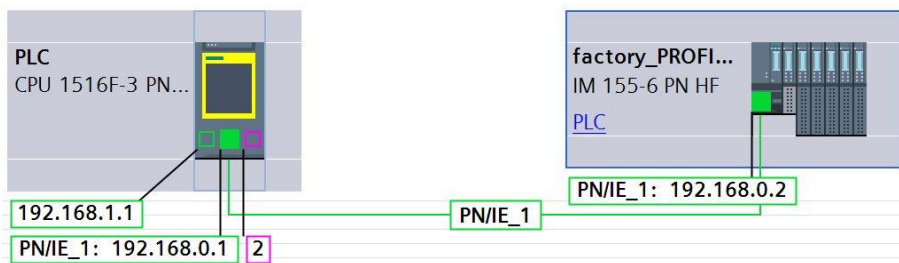

The assemblies used in the alternative solution are shown here:

| Module | Slot | I address | Q address | Type | Article no. |
|--------|------|-----------|-----------|-------------------|---------------------|
| | 100 | | | | |
| | 0 | | | | |
| ▶ PLC | 1 | | | CPU 1516F-3 PN/DP | 6ES7 516-3FN01-0AB0 |

| Module | Slot | I address | Q address | Type | Article number |
|--------------------|------|-----------|-----------|---------------------|---------------------|
| | 300 | | | | |
| ▶ factory_PROFINET | 0 | | | IM 155-6 PN/2 HF | 6ES7 155-6AU01-0CN0 |
| DO1+2 | 1 | | 1...2 | DQ 16x24VDC/0.5A ST | 6ES7 132-6BH01-0BA0 |
| DO3+4 | 2 | | 3...4 | DQ 16x24VDC/0.5A ST | 6ES7 132-6BH01-0BA0 |
| DO5+6 | 3 | | 5...6 | DQ 16x24VDC/0.5A ST | 6ES7 132-6BH01-0BA0 |
| DO7-14 | 4 | | 7...14 | DQ 4x24VDC/2A HS | 6ES7 132-6BD20-0DA0 |
| DO15-22 | 5 | | 15...22 | DQ 4x24VDC/2A HS | 6ES7 132-6BD20-0DA0 |
| DO23-30 | 6 | | 23...30 | DQ 4x24VDC/2A HS | 6ES7 132-6BD20-0DA0 |
| DI1+2 | 7 | 1...2 | | DI 16x24VDC ST | 6ES7 131-6BH01-0BA0 |
| DI3+4 | 8 | 3...4 | | DI 16x24VDC ST | 6ES7 131-6BH01-0BA0 |
| DI5 | 9 | 5 | | DI 8x24VDC HS | 6ES7 131-6BF00-0DA0 |
| DI6 | 10 | 6 | | DI 8x24VDC HS | 6ES7 131-6BF00-0DA0 |
| AI7-10 | 11 | 7...10 | | AI 2xU ST | 6ES7 134-6FB00-0BA1 |
| Servermodul_1 | 12 | | | Server module | 6ES7 193-6PA00-0AA0 |

The program solutions are available at:

https://github.com/fischertechnik/plc_training_factory_24v/PLC_S7_1500_exercises

Note:

This section describes an example of commissioning for a SIEMENS SIMATIC S7-1500 controller with CPU 1516F-3 PN/DP. If a different controller is used, then other software tools must be used to create, and load the programs, and to operate the Training Factory Industry 4.04.0.

The source codes can be imported to create the programs, depending on the controller used. These are available at:

https://github.com/fischertechnik/plc_training_factory_24v/PLC_SCL_sources

Structure and operation of the CPU 1516F-3 PN/DP.

Here is an overview of the elements of the CPU 1516F-3 PN/DP with bus adapter

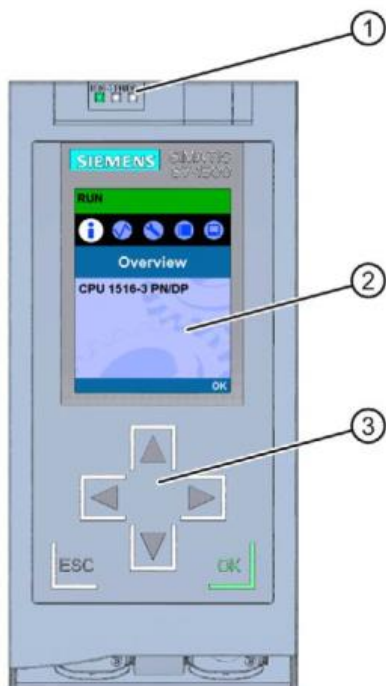

- ① LED indicators for the current operating status and diagnostic status of the CPU
- ② Display
- ③ Operating buttons

Status and error indicators

The CPU is equipped with the following LED indicators:

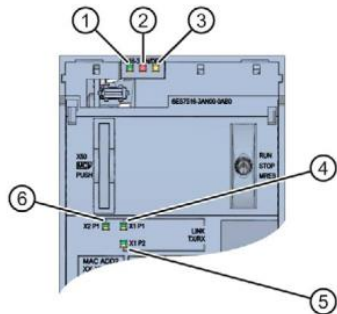

- ① RUN/STOP LED (yellow/green LED)
- ② ERROR-LED (red LED)
- ③ MAINT-LED (yellow LED)
- ④ LINK RX/TX-LED for Port X1 P1 (yellow/green LED)
- ⑤ LINK RX/TX-LED for port X1 P2 (yellow/green LED)
- ⑥ LINK RX/TX-LED for port X2 P1 (yellow/green LED)

Operating and connection elements of the CPU 1516F-3 PN/DP behind the front flap

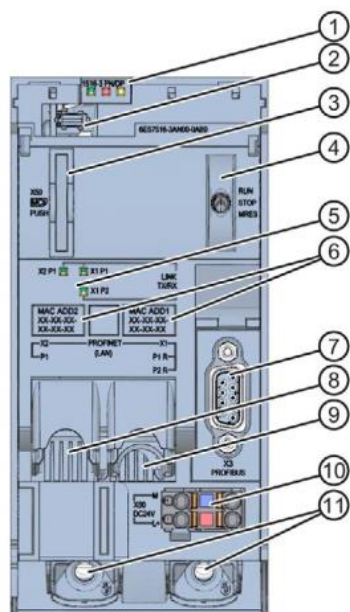

- ① LED indicators for the current operating status and diagnostic status of the CPU
- ② Display connection
- ③ Slot for the SIMATIC Memory Card
- ④ Operating mode switch
- ⑤ LED indicators for the 3 ports on the PROFINET interfaces X1 and X2
- ⑥ MAC addresses of the interfaces
- ⑦ PROFIBUS interface (X3)
- ⑧ PROFINET interface (X2) with 1 port
- ⑨ PROFINET interface (X1) with 2 ports
- ⑩ Connection for supply voltage
- ⑪ Attachment screws

Note: The front flap with display can be removed and inserted while operations are ongoing. The S7-1500 CPU has a front flap with a display and operating buttons. Controlling and status information can be shown on different menus on the display, and a wide variety of settings can be changed. Use the operating buttons to navigate through the menus.

The CPU display offers the following functions:

- You can select from 6 different display languages.
- Diagnostic messages are shown in clear text.
- Interface settings can be changed on site.
- A password can be assigned to operate the display via the TIA portal.

View of the display of an S7-1500:

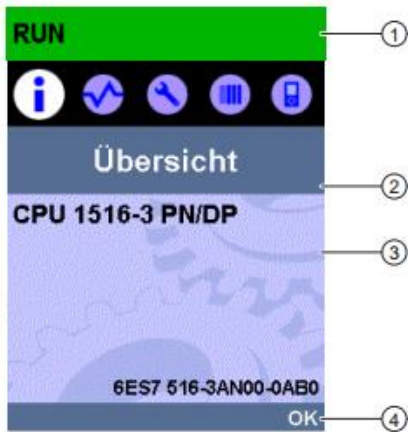

- ① CPU status information
- ② Designation of the sub-menu
- ③ Display field for information
- ④ Navigation tool, e.g. OK/ESC or the page number

SIMATIC Memory Card

A SIMATIC Micro Memory Card is used as the storage module for the CPUs. It is a specially pre-formatted memory card which is compatible with the Windows file system.

The MMC must be inserted to operate the CPU, since the CPUs do not have an integrated load memory for the programs. A common SD card reader is required to read/write the SIMATIC Memory Card with a laptop/PC. It can be used, for instance, to copy files directly to the SIMATIC Memory Card using Windows Explorer, or delete all program data.

Note: We recommend only inserting or removing the SIMATIC Memory Card into/from the CPU when it is powered down.

Operating mode switch

The operating mode switch can be used to set the current CPU operating mode. The operating mode switch is a toggle switch with 3 settings:

| Setting | Meaning | Explanation |
|---------|----------------|------------------------------------|
| RUN | RUN operating | The CPU processes the user program |
| STOP | STOP operating | The CPU processes the user program |
| MRES | Memory reset | Setting to reset the CPU |

Structure and operation of the SIMATIC ET 200SP

The decentralised peripheral device SIMATIC ET 200SP is a modular, decentralised peripheral system for connecting the process signals to a central automation system like SIMATIC S7-1500.

Decentralised peripheral devices are often used when signals need to be transmitted across a large distance, and when this requires a large amount of wiring work. This allows signals to be collected in a decentral manner on site and connected to the central controller via a bus system. The ET 200SP is connected via PROFINET IRT (Isochrones Realtime) for the solution program for the Training Factory Industry 4.04.0.

The decentralised peripheral device ET 200SP is mounted on a standard profile rail (7) and is composed of an interface module (1) with bus adapter (6), up to 32/64 peripheral modules inserted on BaseUnits (2), (3) (4) and a final server module (5).

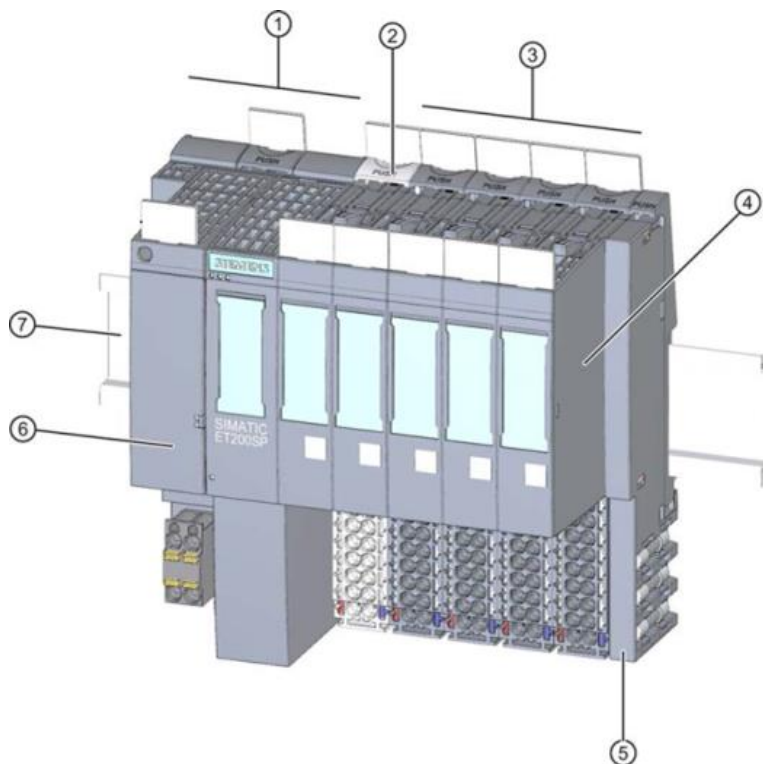

The decentralised peripheral devices provide inputs and outputs for on-site process connection that can be read and written by the central assembly via PROFINET. The I/O assemblies are queried normally in the S7 program via the input addresses (%I) and output addresses (%Q) are addressed.

STEP 7 Professional programming software in the TIA portal

The programming tool STEP 7 Professional is used to program and load the SPSen SIMATIC S7-1500 and commission the ET200SP.

Program solutions for the Training Factory Industry 4.04.0 have been created with version V16 of STEP 7 Professional in the TIA Portal.

Further details on the programming software and PROFINET are provided in the SIEMENS handbooks at: <http://support.automation.siemens.com>.

Resetting the controller and setting the IP address

Before you can load program solutions to the SIMATIC S7-1500, you should reset it to default settings and set the IP address of the CPU 1516F-3 PN/DP.

The following steps can be used to reset the CPU 1516F-3 PN/DP to default settings.

- First, switch off the power supply to the controller and then remove the SIMATIC Micro Memory Card inserted in the CPU 1516F-3 PN/DP.
- To delete all program data from the SIMATIC Micro Memory Card in the CPU, you can simply insert the SIMATIC Memory Card into a common SD card reader and delete data on the card using Windows Explorer.

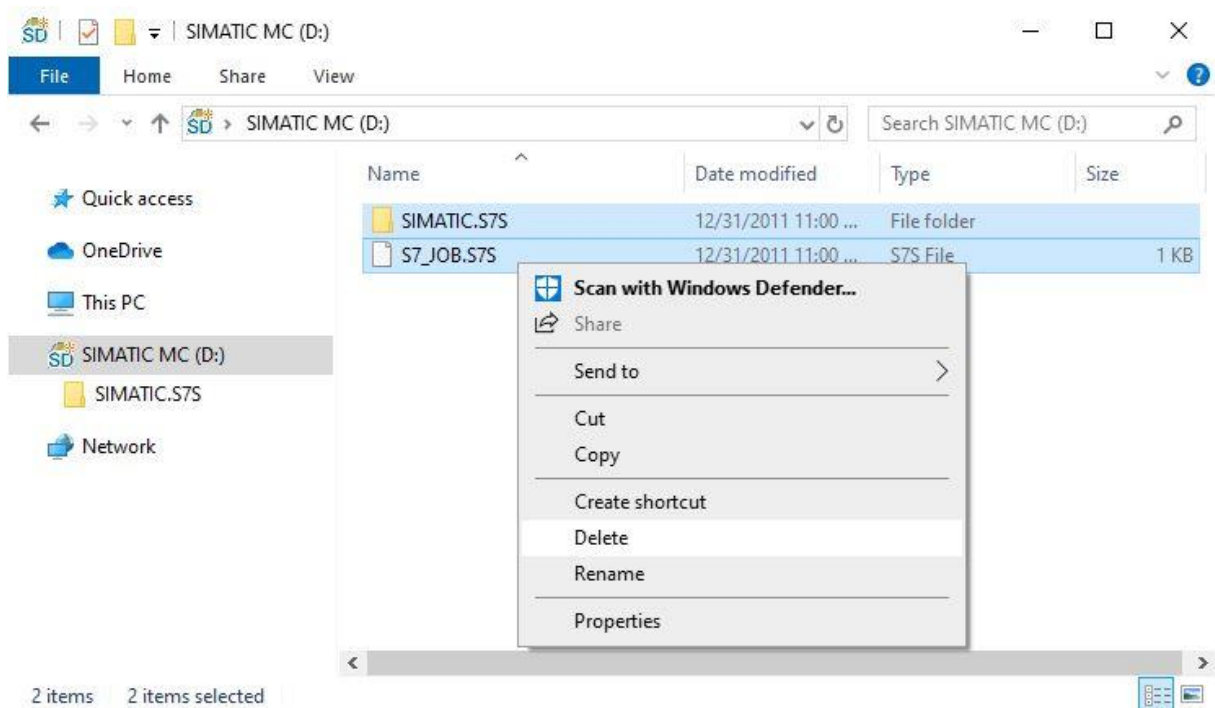

- Then, insert the SIMATIC Memory Card back into the CPU 1516F-3 PN/DP and switch on the power supply to the controller.

Note: We recommend only inserting or removing the SIMATIC Memory Card into/from the CPU when it is powered down. Otherwise, it may be damaged.

Note: You should not format the SIMATIC Memory Card, just delete the data

To be able to program a SIMATIC S7-1500 controller from a laptop/PC from the CPU, you will need a TCP/IP connection.

It is important for the IP addresses of the two devices to match, to ensure the computer and SIMATIC S7-1500 can communicate with one another via TCP/IP.

First, we will show you how to set the IP address of a computer using a Windows 10 operating system.

→ Mark the network symbol below in the task bar  and then click → **Network settings**.



→ In the network settings window that opens, click → **Ethernet** and then click → **Change adapter options**.

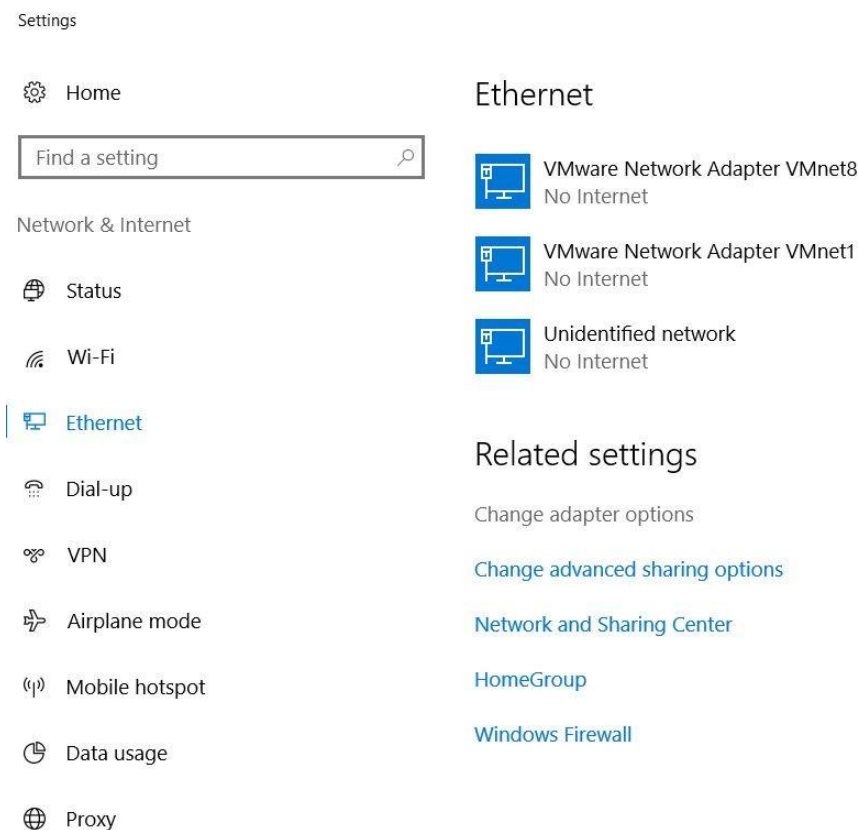

→ Select the desired → **LAN connection** you want use to connect the controller, then click → **Properties**.

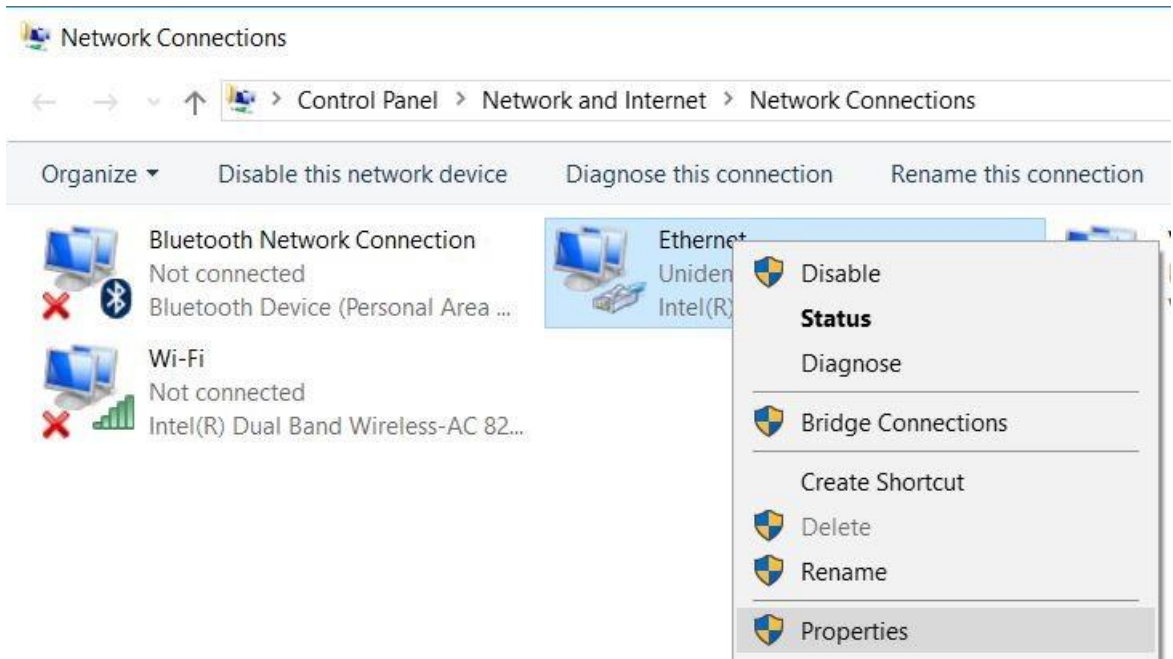

→ Now, select the → **Properties** for → **internet protocol Version 4 (TCP/IPv4)**.

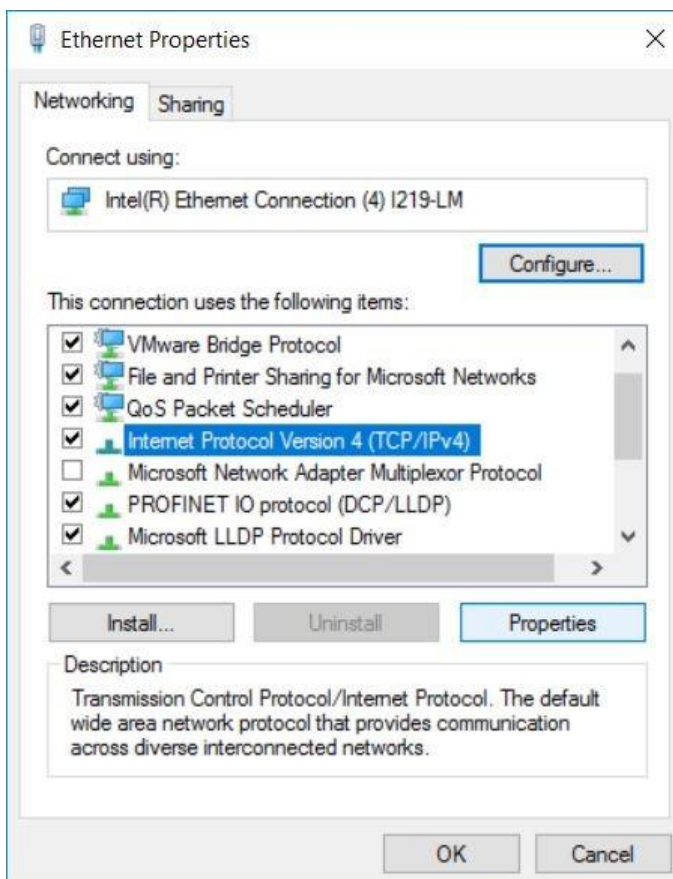

→ Now you can use the following IP address, for instance → **IP address: 192.168.0.99** and enter the following → **subnet mask 255.255.255.0**. Then accept the settings by pressing → **OK**.

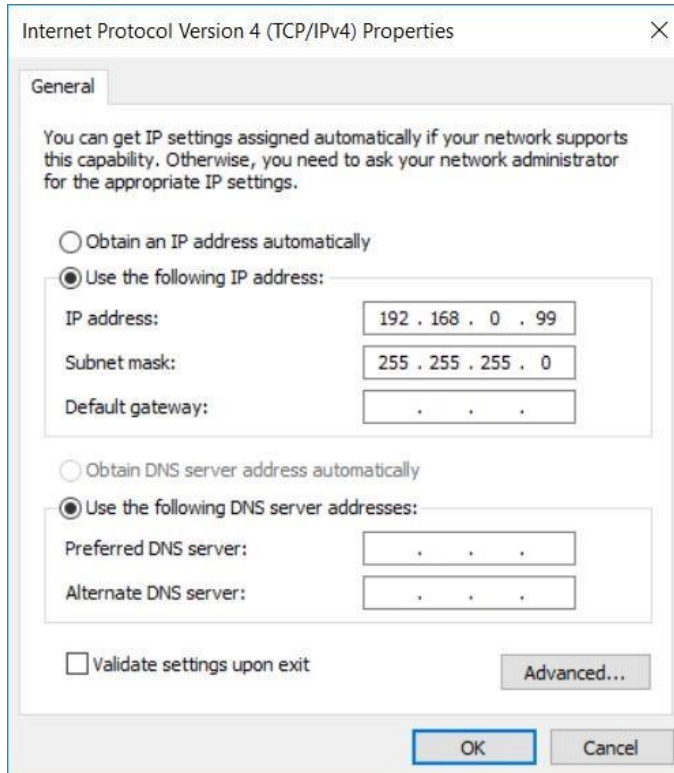

Now, you can assign the IP address to the CPU 1516F-3 PN/DP as shown in the following steps.

→ Connect Port 1 of the Ethernet interface [X1] on the CPU 1516F-3 PN/DP with Port 1 of the Ethernet interface on the ET200SP. Connect your laptop directly to Port 2 of the Ethernet interface [X1] on the CPU 1516F-3 PN/DP. Switch on the power supply to the controller. The other components of the Training Factory Industry 4.0 can be connected to Port 2 of the Ethernet interface on the ET200SP.

Note: A correct network topology is required here, since this topology was determined for PROFINET IRT communication in the project.

→ Now, start the Totally Integrated Automation Portal by double clicking on it. (→ **TIA Portal V16**)



→ Select → **Online&Diagnostics** and then open the → **Project view**.

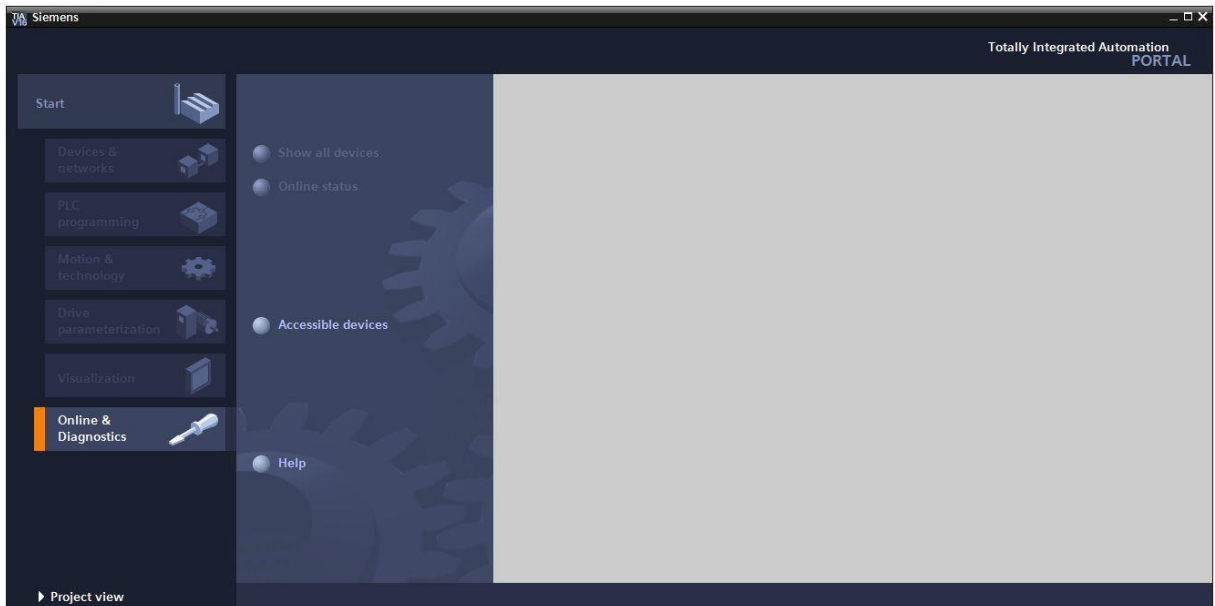

→ In the project navigation, select the previously set network card under → **Online access**. When you click → **Update available devices**, you will see the IP address (if already set) or the MAC address (if the IP address has not yet been assigned) for the connected SIMATIC S7-1500. Here, select → **Online&Diagnostics**.

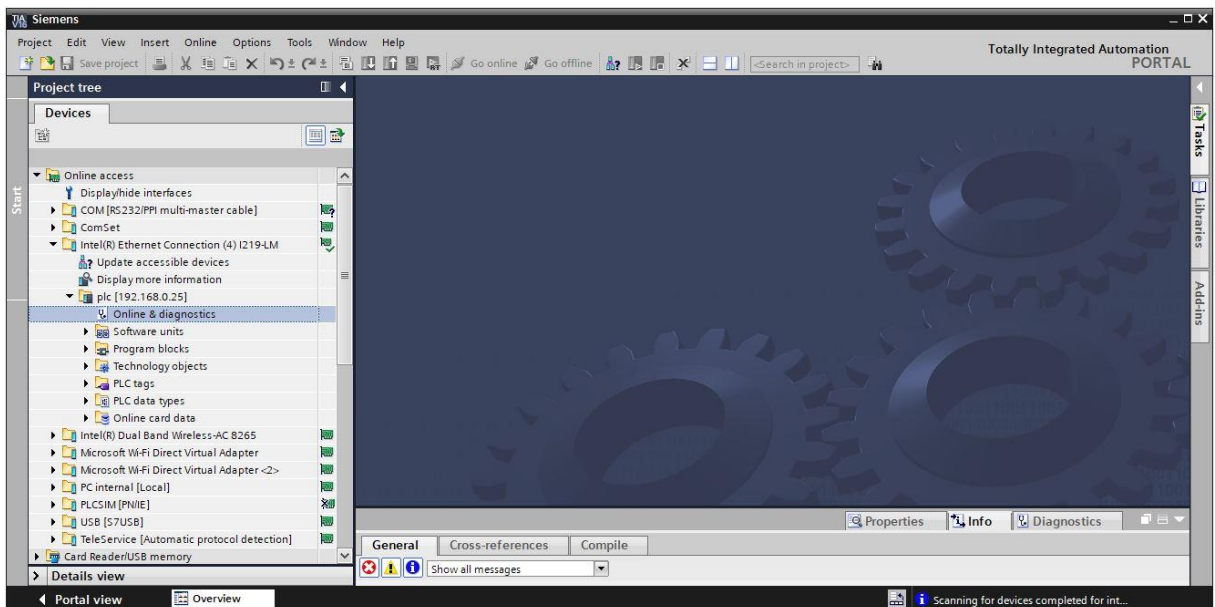

→ You will find → **Assign IP address** under → **Functions**. Here, enter the following IP address, for instance: → **IP address: 192.168.0.1** → **Subnet mask 255.255.255.0**. Now, click → **Assign IP address** and your SIMATIC S7-1500 will be assigned this new address.

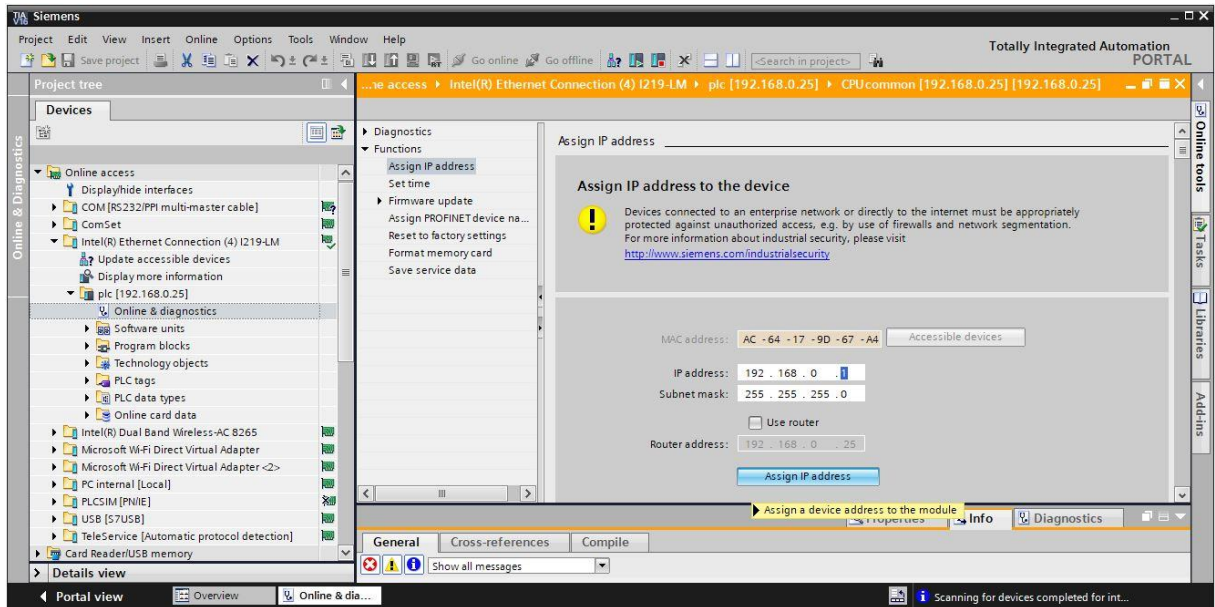

→ The → **Info** → **General** window provides messages on the status of address assignment.

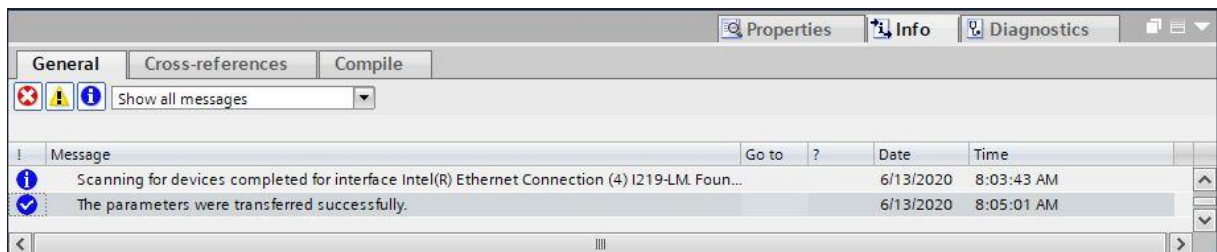

Open the program solutions for the Training Factory Industry 4.04.0

Open the program solutions for the Training Factory Industry 4.04.0 using the following steps.

→ In the menu of the TIA portal, select → **Project** → **Open** and then → **Search**.

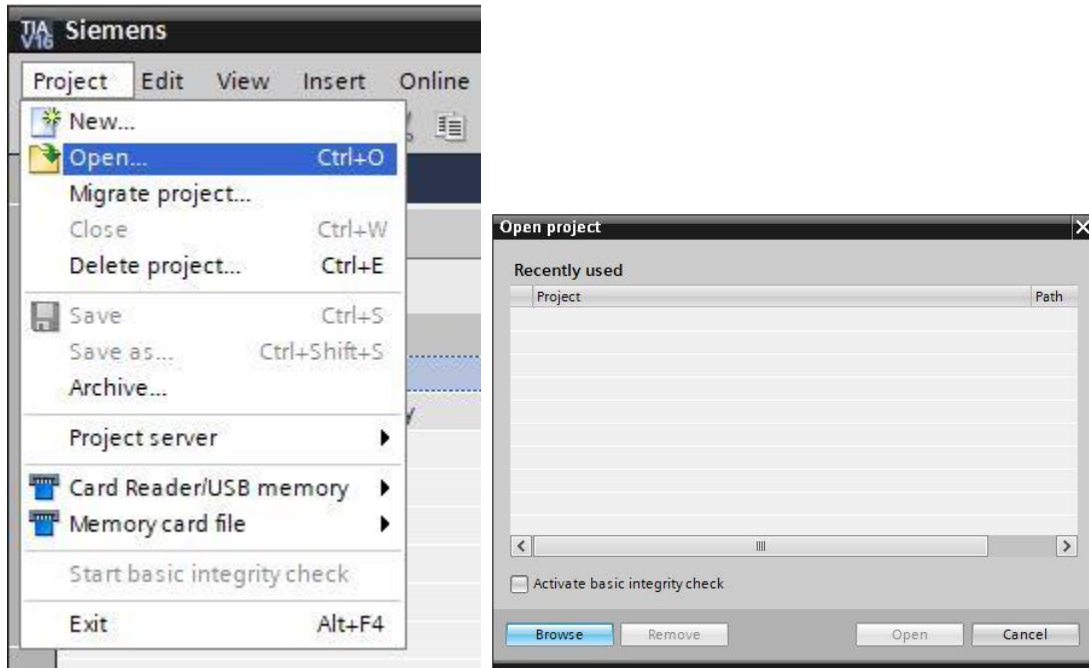

→ Then, click the compressed V16 project → **LearningFactory_4_0_24V_PROFINET** and select a target path on your computer to unpack the project there.

 LearningFactory_4_0_24V_PROFINET_V02

13.06.2020 21:39

Siemens TIA Portal V16 compressed project

2.913 KB

Note: The program solutions are available at:
https://github.com/fischertechnik/plc_training_factory_24v/PLC_S7_1500_exercises

Adapting the hardware configuration

The project is now open and will be displayed in the project navigation at left.

If your hardware components differ from those in the program solutions, these components must be adjusted in the TIA portal.

→ To do so, first open the → **Device configuration**.

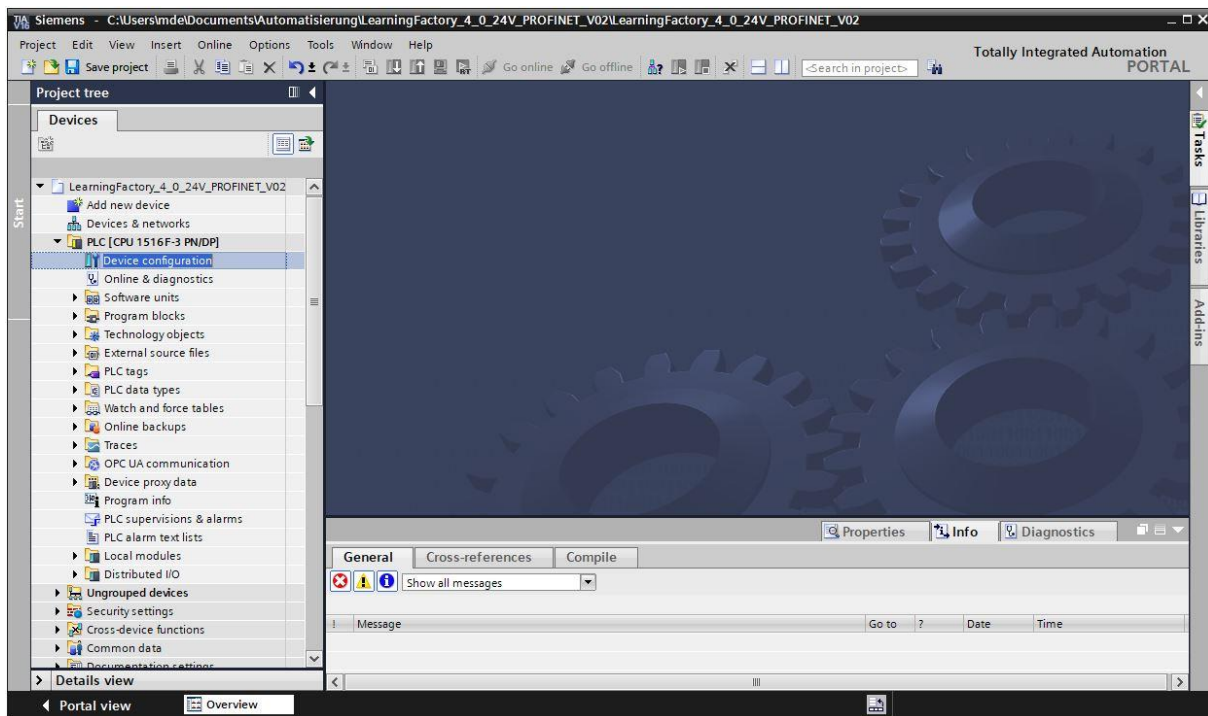

→ Mark one of the different components and then click → **Exchange device.**

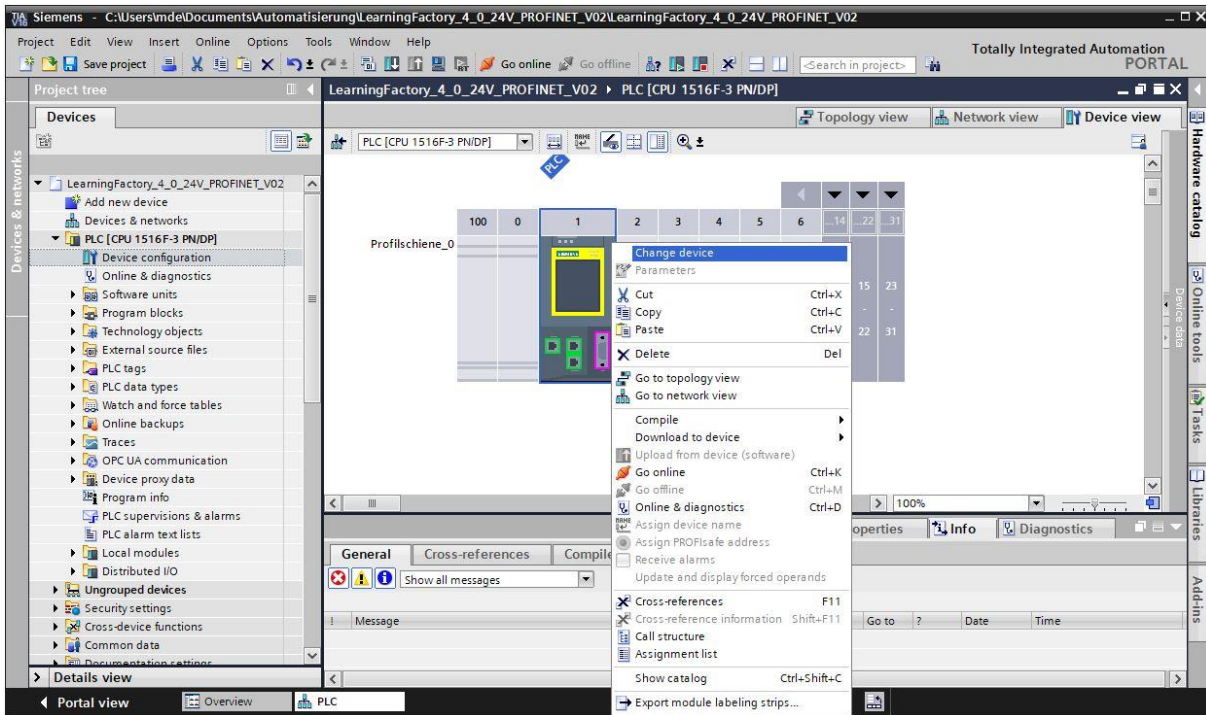

→ You will then see a dialogue where you can select from compatible devices.

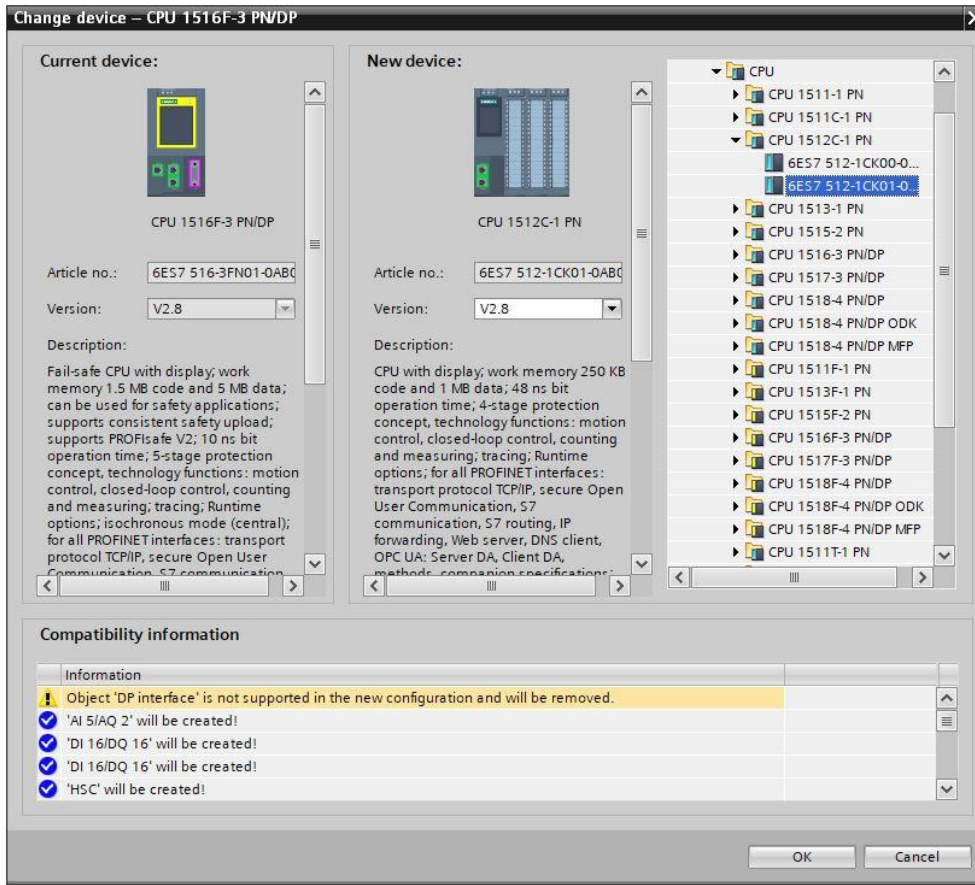

→ To see an overview of associated IP addresses in a project, click the → **Display addresses** symbol in the  **Network view**.

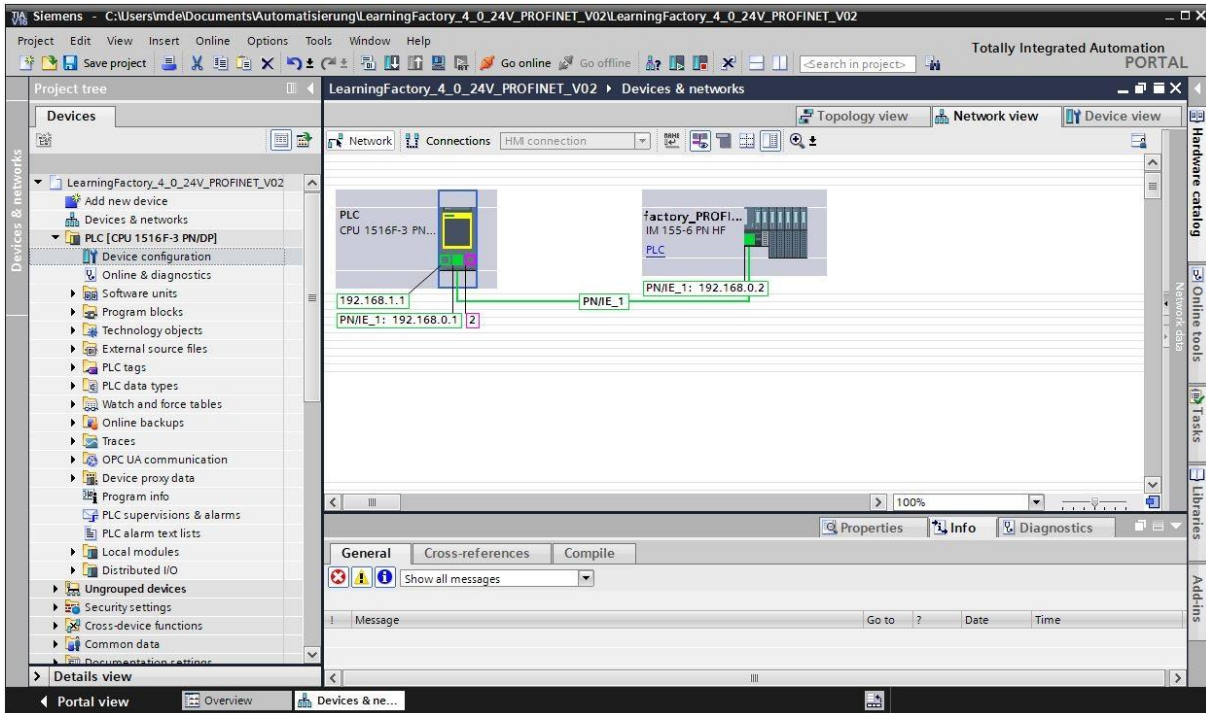

You must select the correct BaseUnit for the signal modules of the ET200SP:

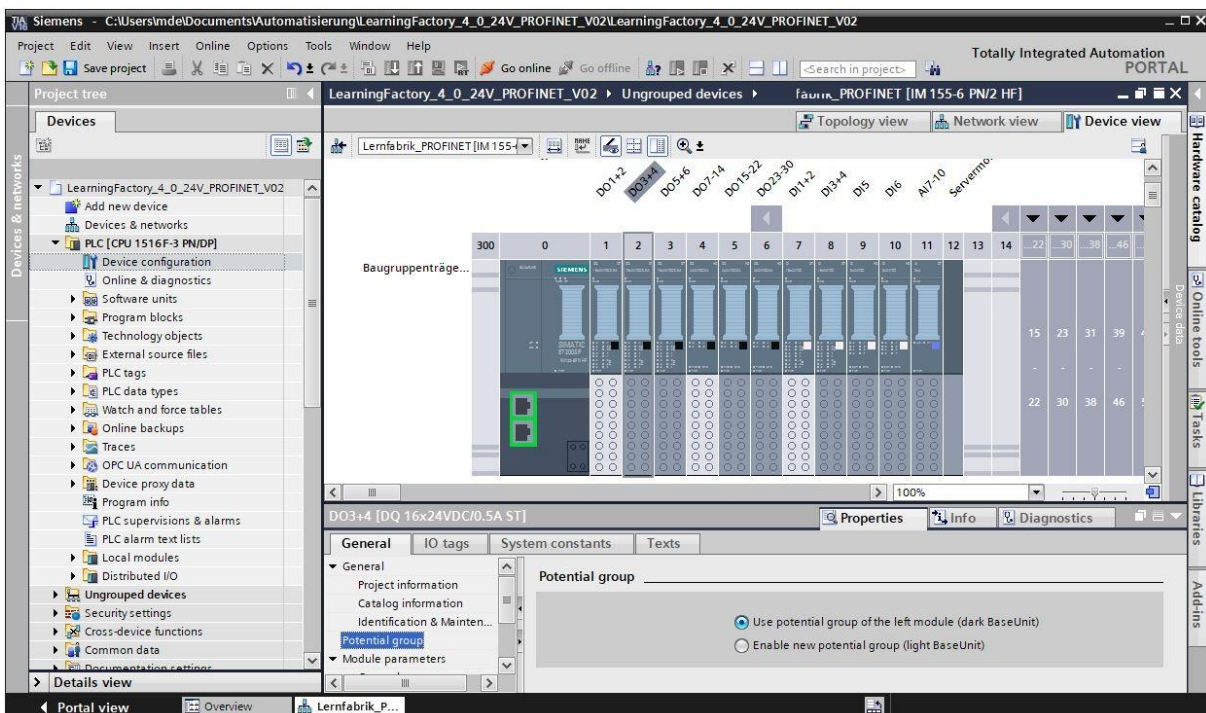

- Use potential group for the left module (dark BaseUnit)
- Facilitate new potential group (light BaseUnit)

→ You can change this setting in the → **Device view** of the ET200SP under → **Properties** → **General** → **Potential group**.



Load the control program to the CPU 1516F-3 PN/DP

The following steps can be used to load the CPU 1516F-3 PN/DP.

- Before you continue, you should click the →  **Save project** button to save your project.
- To load your entire CPU, including hardware configuration and program solutions, to the device, mark the → PLC [CPU 1516F-3 PN/DP] folder and click the →  **Load to device** symbol.

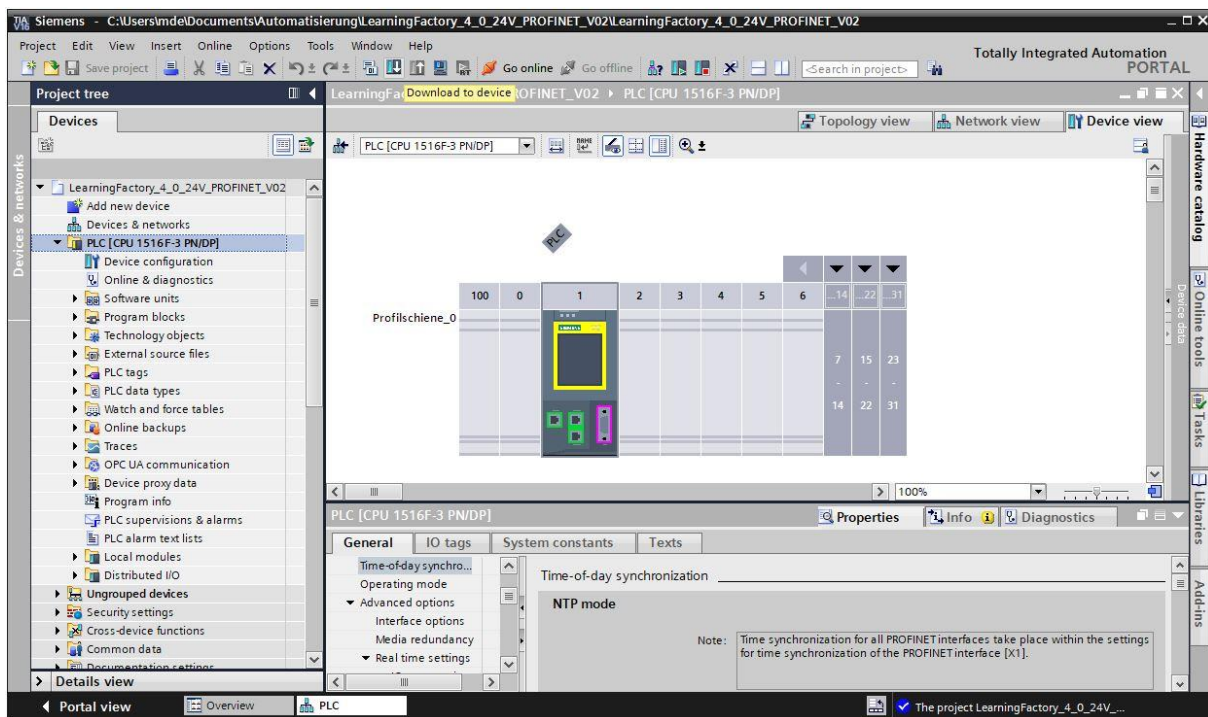

→ The Manager will open for configuring connection properties (**expanded loading**). First, select the correct interface. This involves three steps.

- **Type of PG/PC interface** → PN/IE
- **PG/PC interface** → here, for instance.: Intel(R) Ethernet Connection ...
- **Connection with interface/subnet** → Directly to port ,1 X1'

Then, activate the field → **Display all compatible devices**, and start the search for devices on the network by clicking the → **Start search** button.

If your CPU is displayed in the list, select it and start loading.

(Load → CPU 1516F-3 PN/DP→)

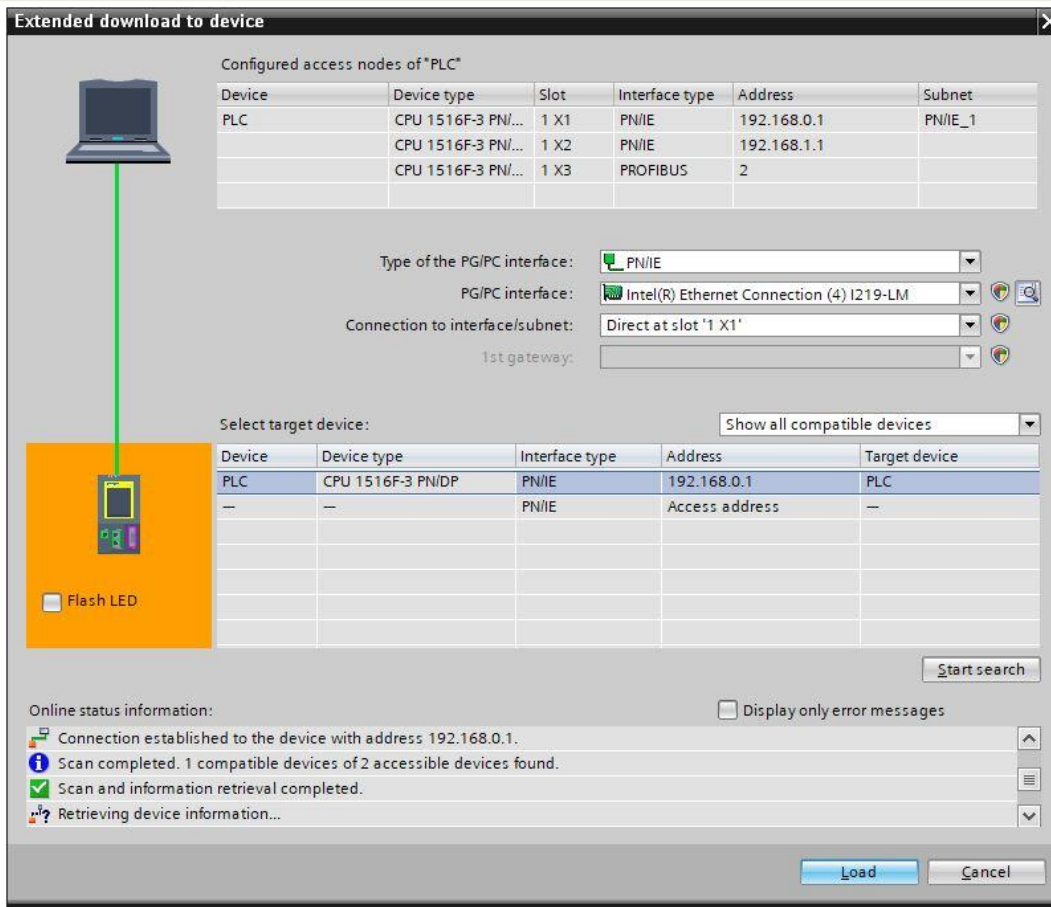

→ First, you will see a preview with information on the loading process, data security, etc... Continue with → **loading**.



→ Now, select the option → **Start assembly** before completing the loading process with → **Complete**.

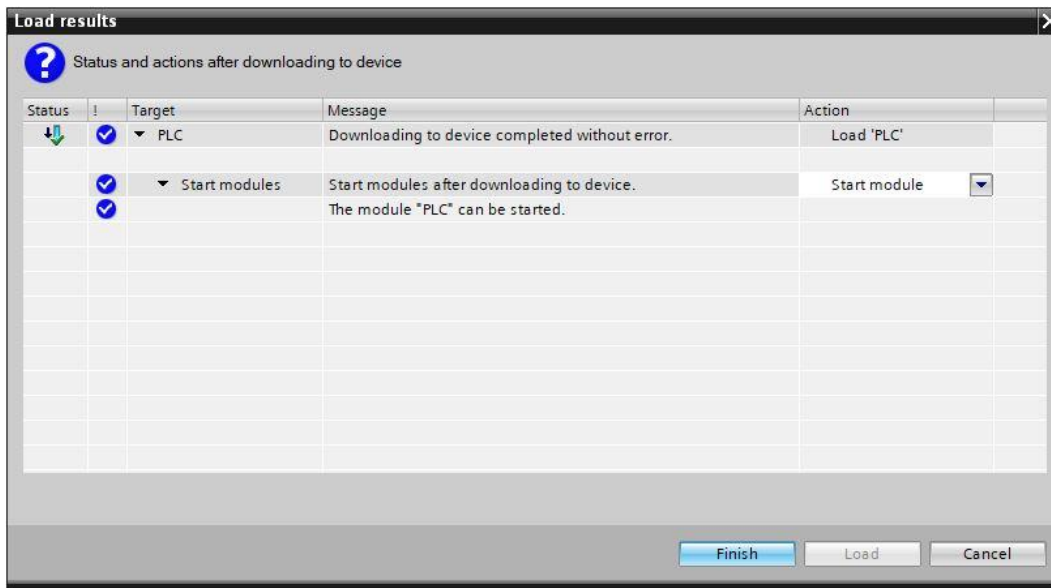

Assign the device name for the PROFINET- IO- Device ET200SP

The device name is used by the IO-Controller CPU 1516F-3 PN/DP to detect the IO-Device ET200SP and establish communication. Because of this, it must be assigned separately.

Use the following steps to do so.

→ In the → **Network view**, mark the ET200SP with the device name → **factory_PROFINET** and select

→  **Assign device name.**

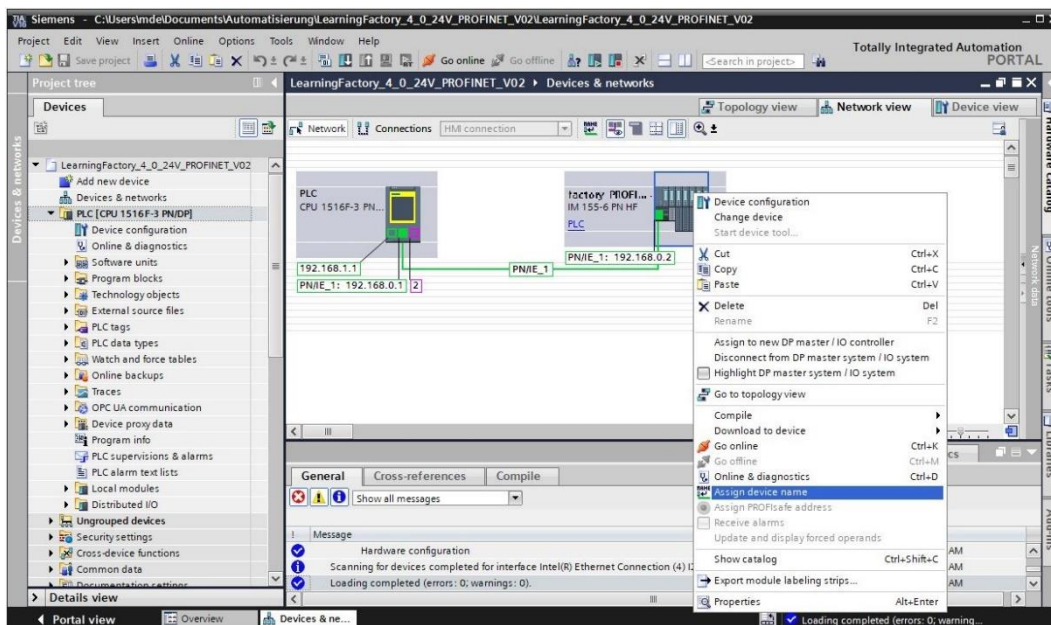

Note: The IP address set in the project is assigned later by the CPU 1516F-3 PN/DP controller when establishing the communication connection.

→ Online access must be set correctly in the dialogue used to assign PROFINET device names. Then, you can select the device and filter by devices of the same type. If a new device is connected, the list must be updated. (→ **PROFINET device name: factory_profinet** → **Type of PG/PC interface: PN/IE** → **PG/PC interface: here: Intel(R) Ethernet Connection ...** → **Only display devices of the same kind** → **Update list**). Determine the right device using the MAC address printed on the device before marking it, then click → **Assign name** to assign the device name.

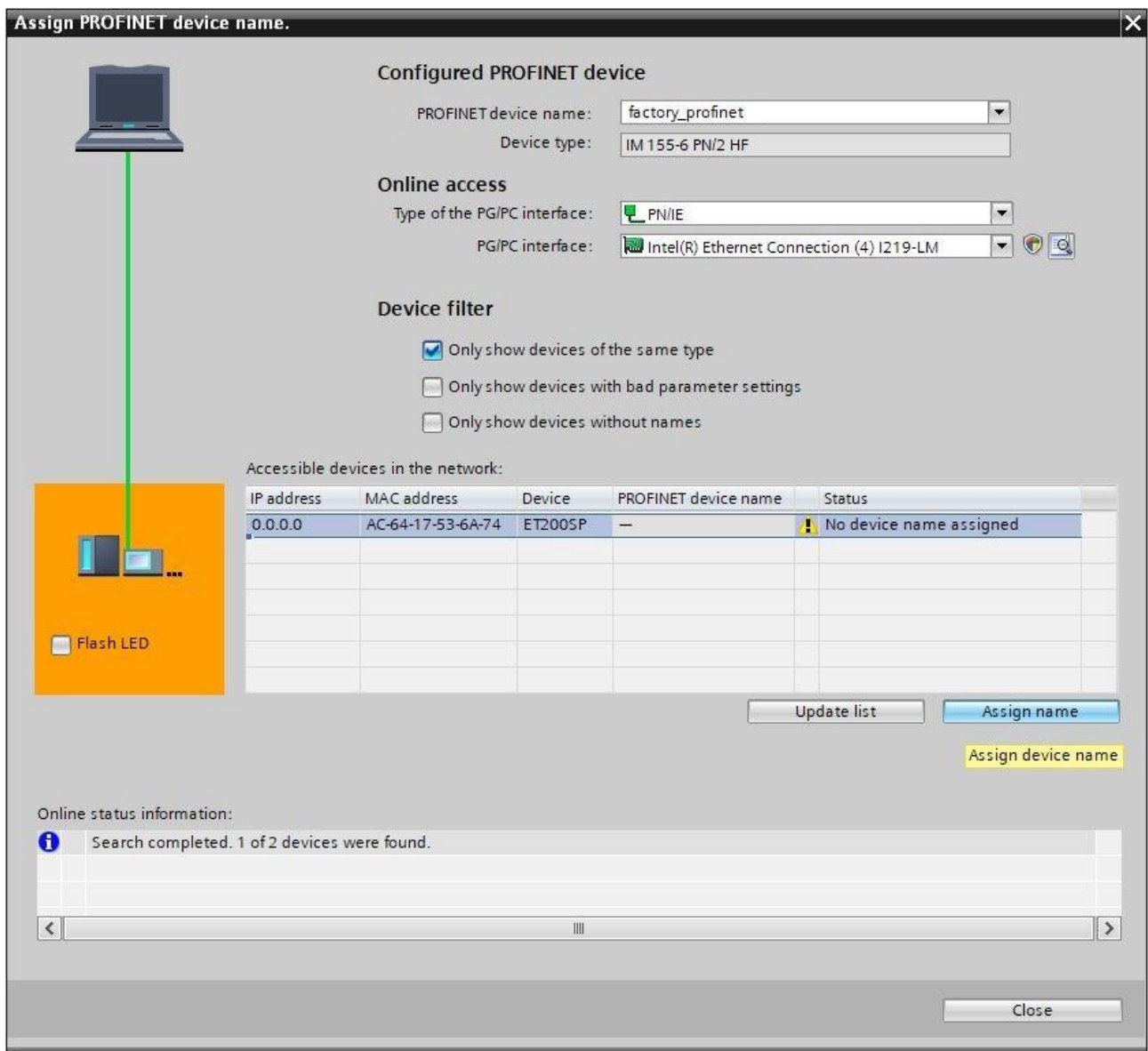

Finally, check online to ensure the configuration was loaded correctly and the PROFINET device was successfully connected by the controller. Then, set the time in the CPU if the set NTP server is not available for automatic time synchronisation.

→ Mark the CPU → **PLC[CPU 1516F-3 PN/DP]** and select → **Connect online.**

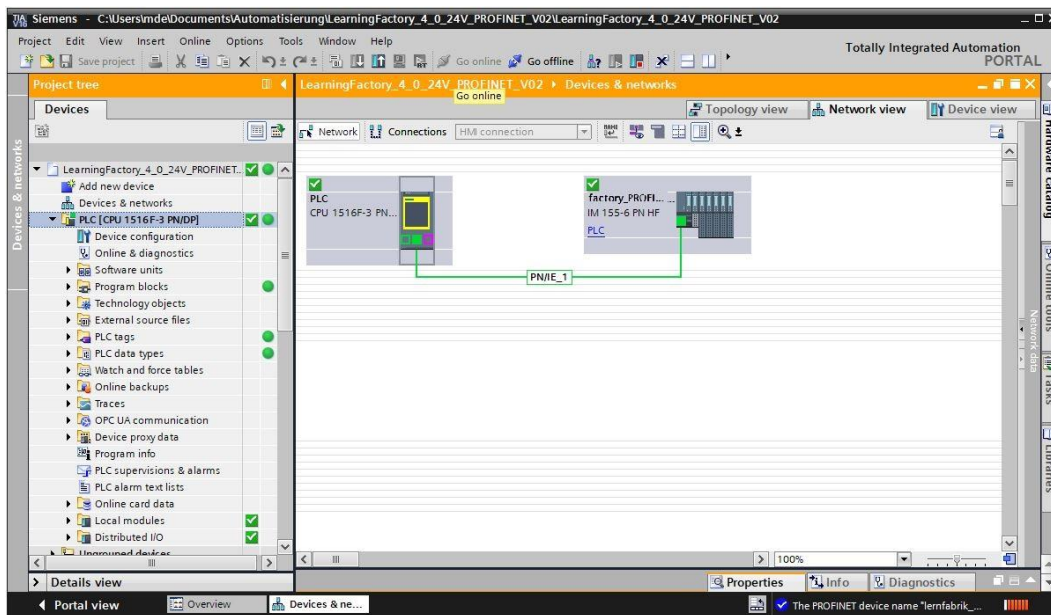

Note: The symbol should be green here if there are no errors.

→ To set the time, open → **Online & Diagnostics**, then select → **Set time** under → **Functions** and then → **Accept**, to adopt the time from your laptop/PC.

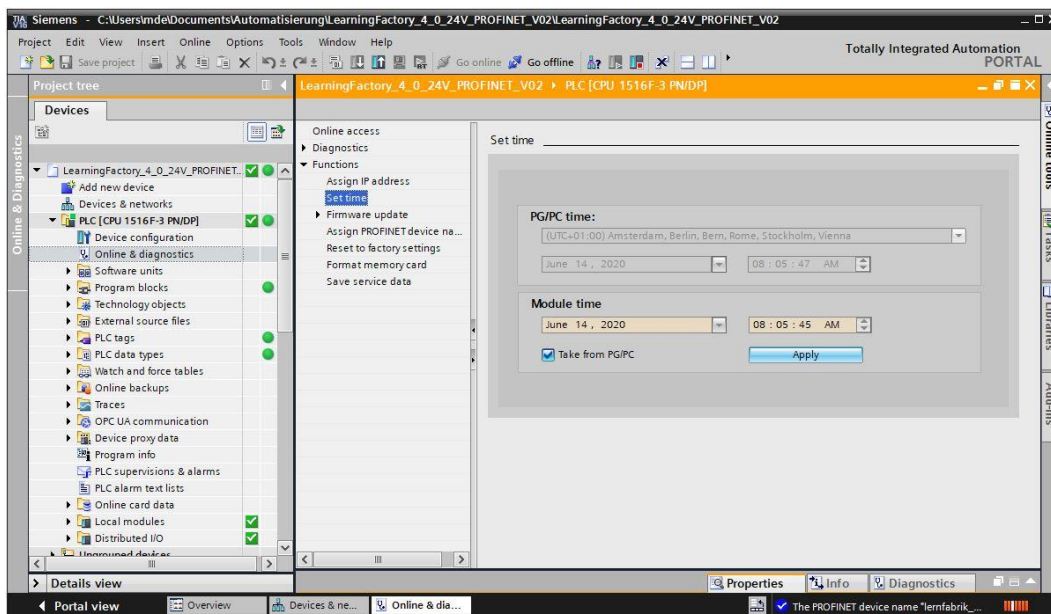

Connecting Training Factory Industry 4.04.0 to the Internet

To connect Training Factory Industry 4.04.0 to the internet and thereby to the fischertechnik cloud, connect the nano Router TP-Link in WISP mode (Hotspot Router Mode) to a wireless WAN.

Then, you can access the Dashboard of the fischertechnik cloud via mobile devices like a tablet, smartphone, laptop, or PC.

Connecting the nano Router TP-Link (WR802N) in WISP mode

The nano router TP-Link is connected to the IOT Gateway (Raspberry Pi) for power supply via USB. Alternatively, however, it can also be connected to the included plug-in power supply.

The Ethernet cable of the nano Router TP-Link is connected directly to a free port on the PLC.

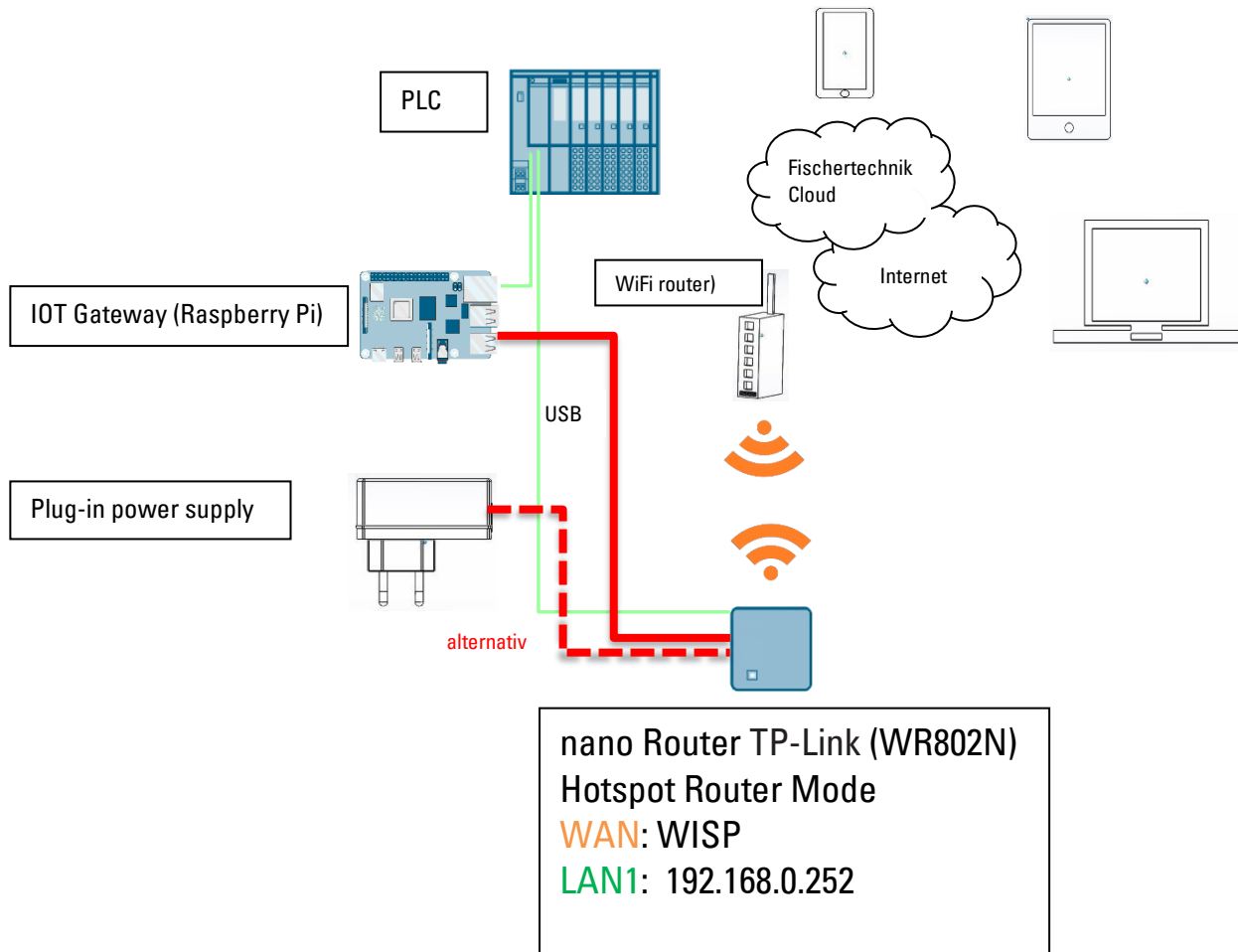



The TP-Link must be configured to connect the nano Router TP-Link in WISP mode (Hotspot Router Mode) to a wireless WAN.

Use your PC or a tablet to do so.

Important: Unplug your computer's (WiFi capable) existing internet connection with the router. To do so, unplug the Ethernet LAN cable from the computer, and terminate any existing WiFi connection.

The nano Router TP-Link is permanently installed in your system. You must first perform a reset before you integrate (configure) it into your working environment. Unplug the plug for the power supply on the TP-Link, then plug it back in so that it restarts. The green light will flash on the TP-link. Use a pointed object (small screwdriver) to press the reset button for 5 seconds. The lamp will go off. The TP-Link will restart. The lamp will flash again.



Press the →  **Internet access** button to open the Internet access context menu on your computer. A screen will appear showing the networks in your area. The TP-Link should appear in the list. Click on →**WiFi** once and then →**WiFi** once again if it doesn't. This will restart the WiFi, and another search will be completed for all WiFi networks.

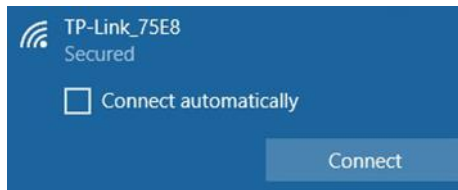

In the next step, activate the displayed TP-link. An additional context menu will appear. Select the → **Connect** button.

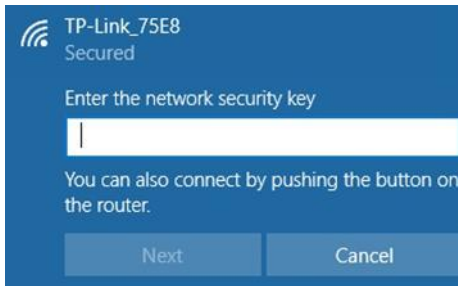

After a short while, a pop-up window will appear asking you to enter the network security key for your TP-link.

This can be found on the bottom of the TP-link.

After entering the key, confirm by pressing the → **Next** button.

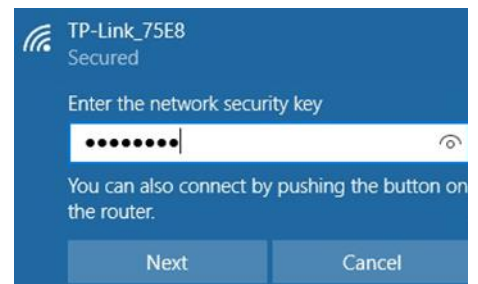

The next step is to check the security key and the TP-link is now connected to your computer via WiFi.

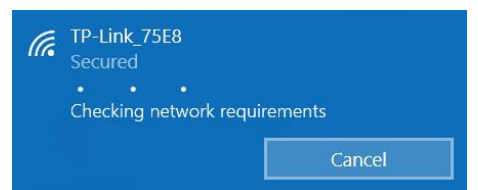

The last pop-up window will show you that the connection is successful.

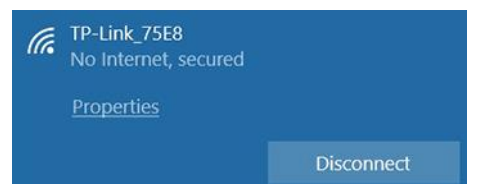

Next, you need to configure the TP-link for your network. To do this, open a WEB browser (Firefox or Chrome).

Access the page <http://tplinkwifi.net> **Important note:** Do not enter **www.** before the address and go to this page. The following page will appear:

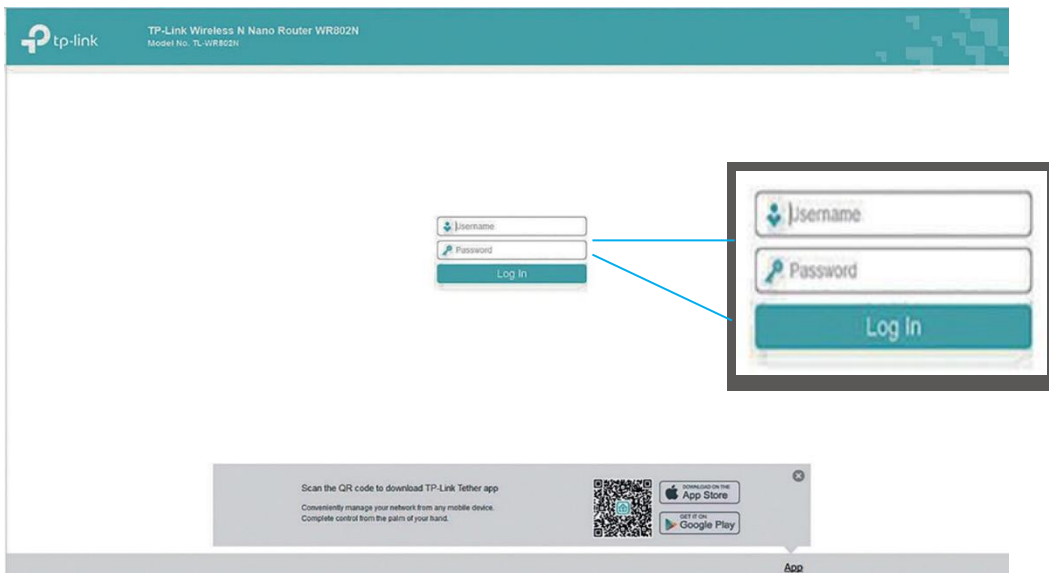

Enter **“admin”** as the user name and **“admin”** as the password, and confirm by pressing **“Log In”**.

Confirm this page with setup information by pressing → **Next**.

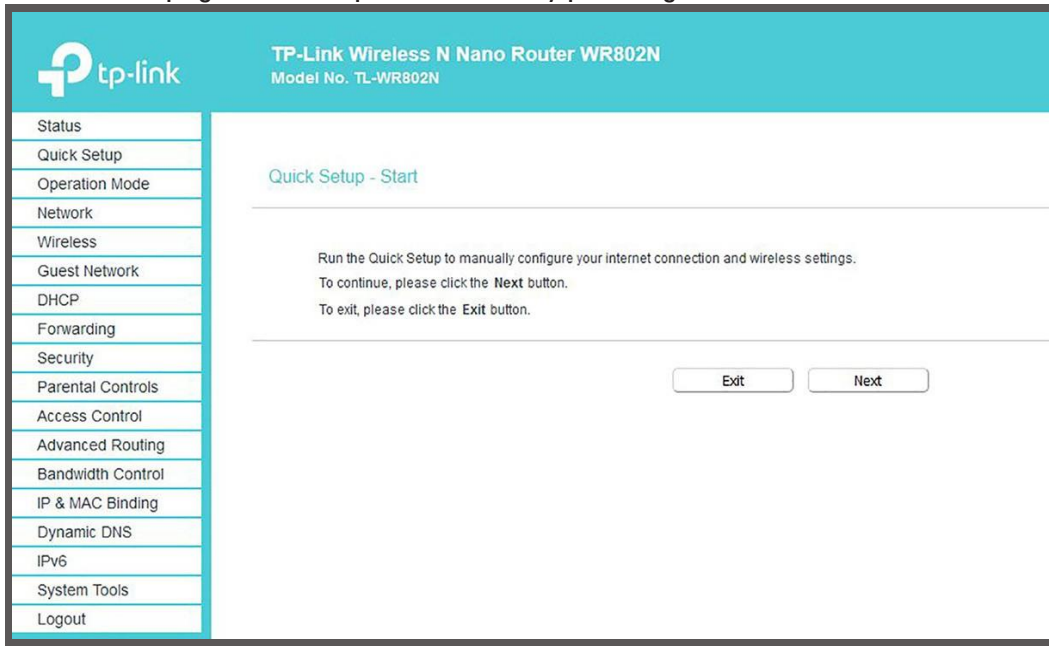

The password should not be changed, otherwise it has to be changed on the TXT Controller. Confirm by pressing → **Next**

Change Login Password

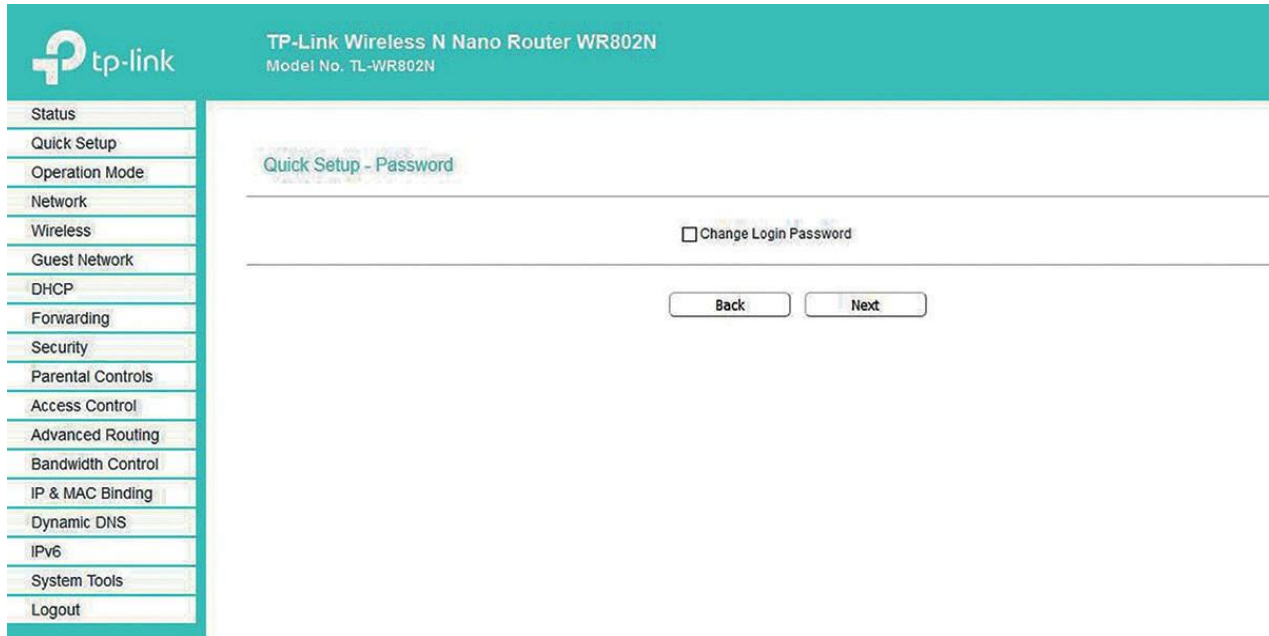

The screenshot shows the TP-Link router's web interface. The top header includes the TP-Link logo and the model name 'TP-Link Wireless N Nano Router WR802N' with model number 'TL-WR802N'. A left sidebar contains a menu with options: Status, Quick Setup, Operation Mode, Network, Wireless, Guest Network, DHCP, Forwarding, Security, Parental Controls, Access Control, Advanced Routing, Bandwidth Control, IP & MAC Binding, Dynamic DNS, IPv6, System Tools, and Logout. The main content area is titled 'Quick Setup - Password' and features a checkbox labeled 'Change Login Password'. At the bottom of the main area are two buttons: 'Back' and 'Next'.

Then, select → **Operation Mode** → **WISP** and confirm the selection with → **Next**.

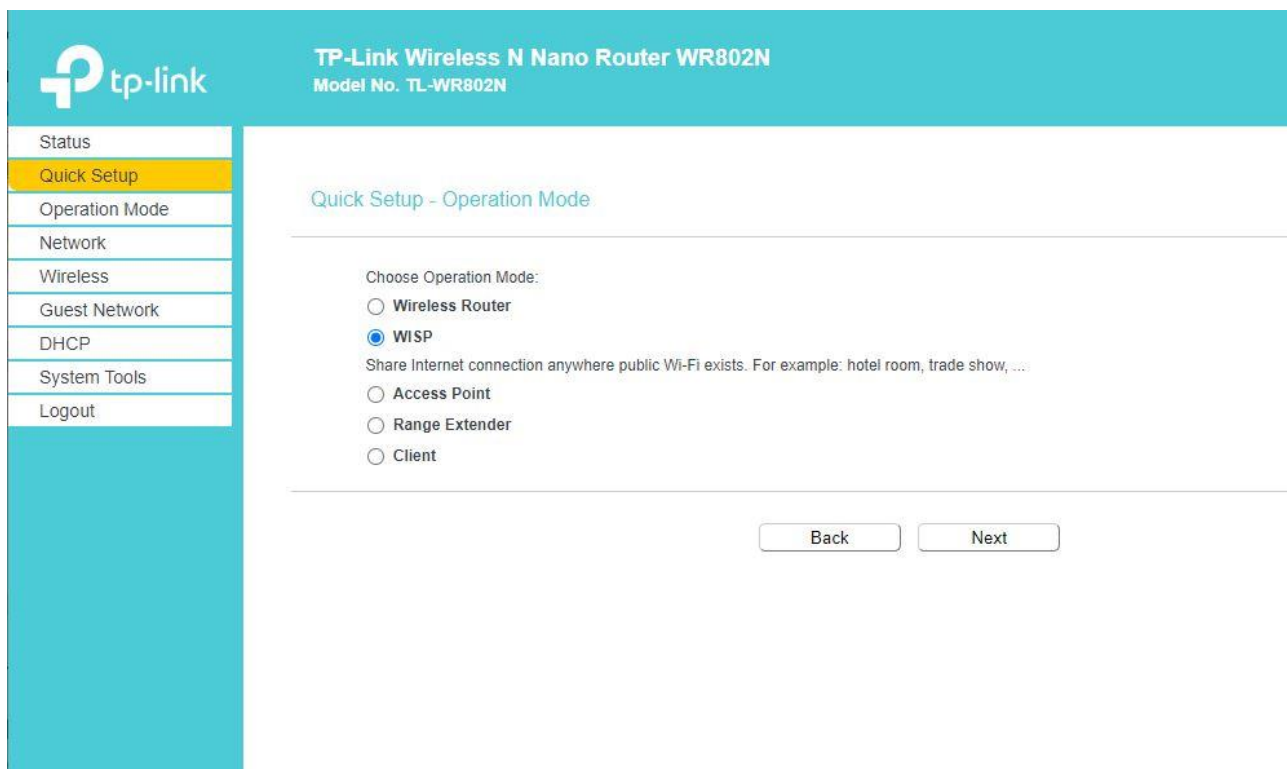

The screenshot shows the TP-Link router's web interface at the 'Quick Setup - Operation Mode' screen. The top header and left sidebar are identical to the previous screenshot. The main content area is titled 'Quick Setup - Operation Mode' and contains a section 'Choose Operation Mode:' with five radio button options: 'Wireless Router', 'WISP', 'Access Point', 'Range Extender', and 'Client'. The 'WISP' option is selected. Below the options is a descriptive text: 'Share Internet connection anywhere public Wi-Fi exists. For example: hotel room, trade show, ...'. At the bottom of the main area are two buttons: 'Back' and 'Next'.

For the → **WAN Connection Type**, select → **Dynamic IP** and confirm the selection with → **Next**.

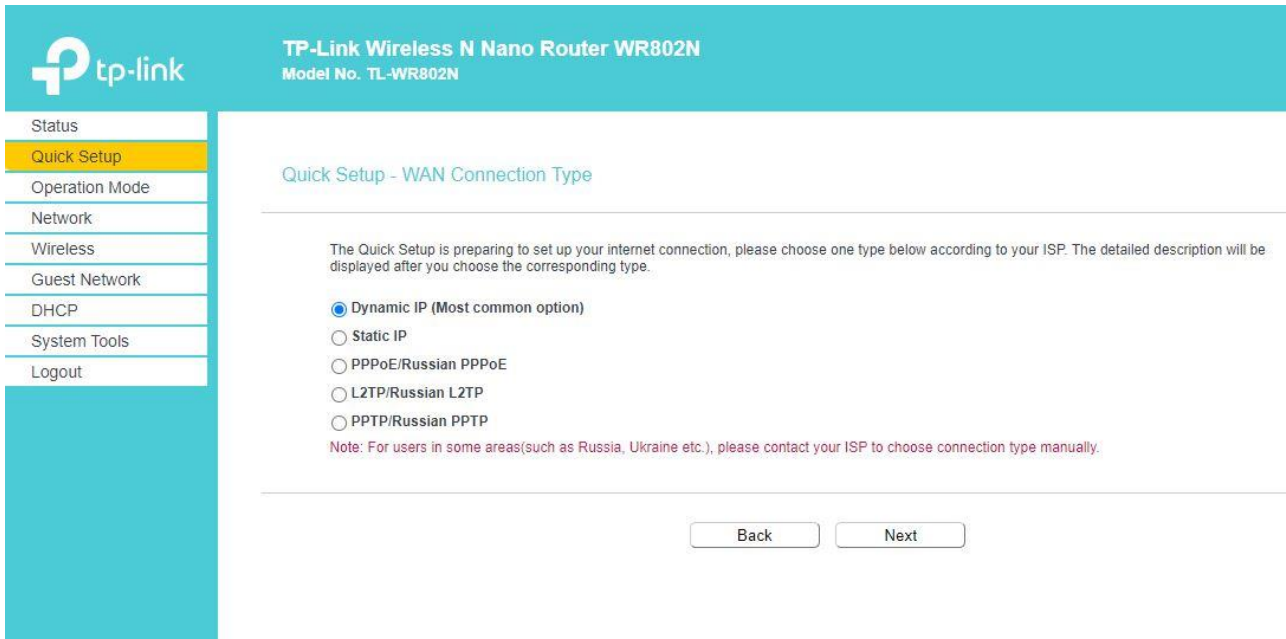

The screenshot shows the 'Quick Setup - WAN Connection Type' page for a TP-Link Wireless N Nano Router WR802N. The left sidebar contains navigation options: Status, Quick Setup (highlighted), Operation Mode, Network, Wireless, Guest Network, DHCP, System Tools, and Logout. The main content area has the title 'Quick Setup - WAN Connection Type' and a sub-header 'Quick Setup - WAN Connection Type'. Below this, there is a paragraph explaining that the Quick Setup is preparing to set up the internet connection and that the user should choose a type based on their ISP. There are five radio button options: 'Dynamic IP (Most common option)' (selected), 'Static IP', 'PPPoE/Russian PPPoE', 'L2TP/Russian L2TP', and 'PPTP/Russian PPTP'. A note at the bottom states: 'Note: For users in some areas (such as Russia, Ukraine etc.), please contact your ISP to choose connection type manually.' At the bottom of the page, there are two buttons: 'Back' and 'Next'.

Next, the → **AP List** will appear with nearby available WiFi Access Points (APs). Select your WiFi access point by clicking → **Connect**

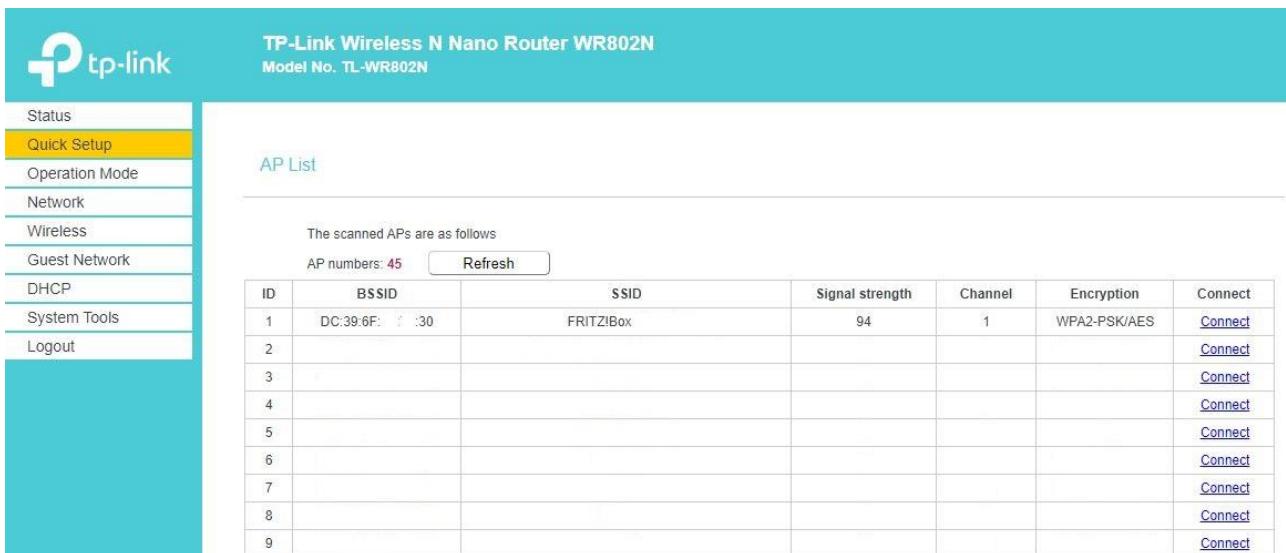

The screenshot shows the 'AP List' page for the same TP-Link router. The left sidebar is identical to the previous screenshot. The main content area has the title 'AP List' and a sub-header 'AP List'. Below this, there is a paragraph stating 'The scanned APs are as follows' and 'AP numbers: 45' with a 'Refresh' button. A table lists the scanned APs with columns for ID, BSSID, SSID, Signal strength, Channel, Encryption, and Connect. The first row shows an AP with BSSID DC:39:6F:...:30 and SSID FRITZ!Box. The other rows are empty.

| ID | BSSID | SSID | Signal strength | Channel | Encryption | Connect |
|----|---------------|-----------|-----------------|---------|--------------|-------------------------|
| 1 | DC:39:6F: :30 | FRITZ!Box | 94 | 1 | WPA2-PSK/AES | Connect |
| 2 | | | | | | Connect |
| 3 | | | | | | Connect |
| 4 | | | | | | Connect |
| 5 | | | | | | Connect |
| 6 | | | | | | Connect |
| 7 | | | | | | Connect |
| 8 | | | | | | Connect |
| 9 | | | | | | Connect |

Adopt the → **Client Settings** and → **AP Settings** with → **Next**.

Note: The **AP Settings** should not be changed; otherwise the settings of the TXT controller will have to be adjusted. You can take the **Client Settings** and **Wireless Password** from the configuration pages for your WiFi access point, or request them from your network administrator.

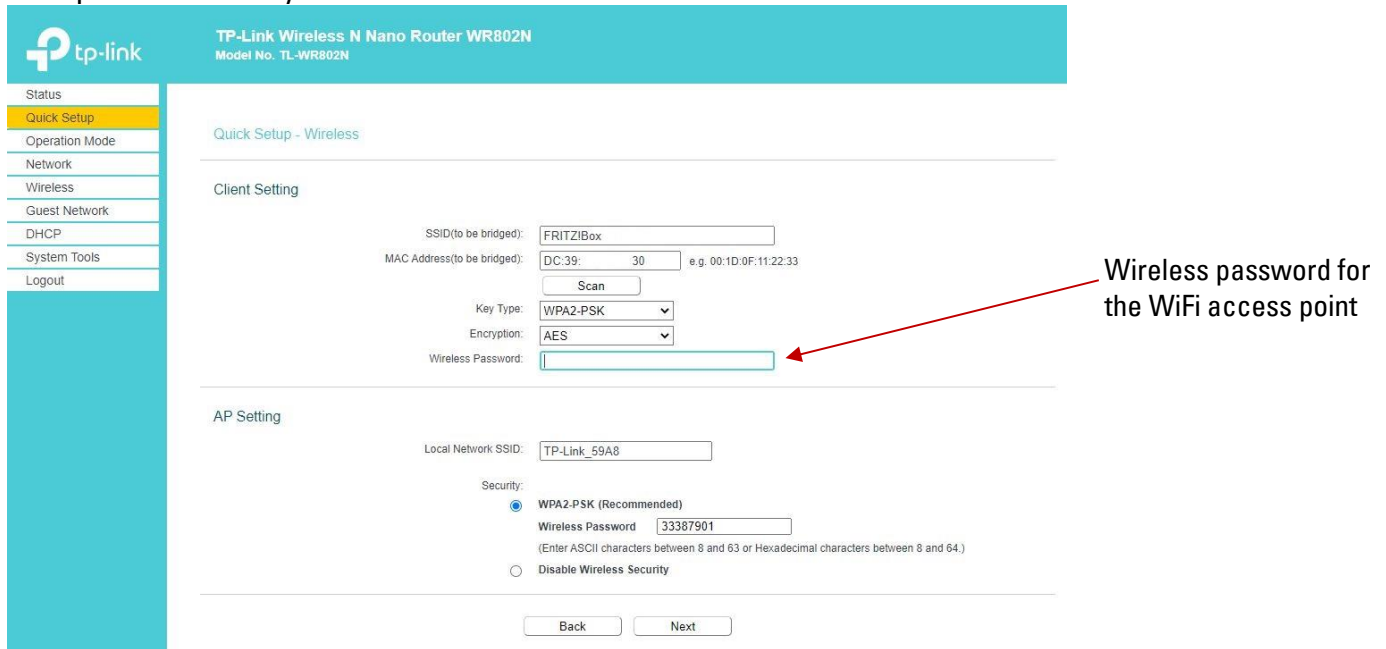

TP-Link Wireless N Nano Router WR802N
Model No. TL-WR802N

Quick Setup - Wireless

Client Setting

SSID(to be bridged): FRITZ!Box
 MAC Address(to be bridged): DC:39: 30 e.g. 00:1D:0F:11:22:33
 Scan
 Key Type: WPA2-PSK
 Encryption: AES
 Wireless Password: []

AP Setting

Local Network SSID: TP-Link_59A8
 Security:
 WPA2-PSK (Recommended)
 Wireless Password 33387901
 (Enter ASCII characters between 8 and 63 or Hexadecimal characters between 8 and 64.)
 Disable Wireless Security

Back Next

Wireless password for the WiFi access point

Then you will see an overview of settings. Adopt them by clicking → **Finish**.

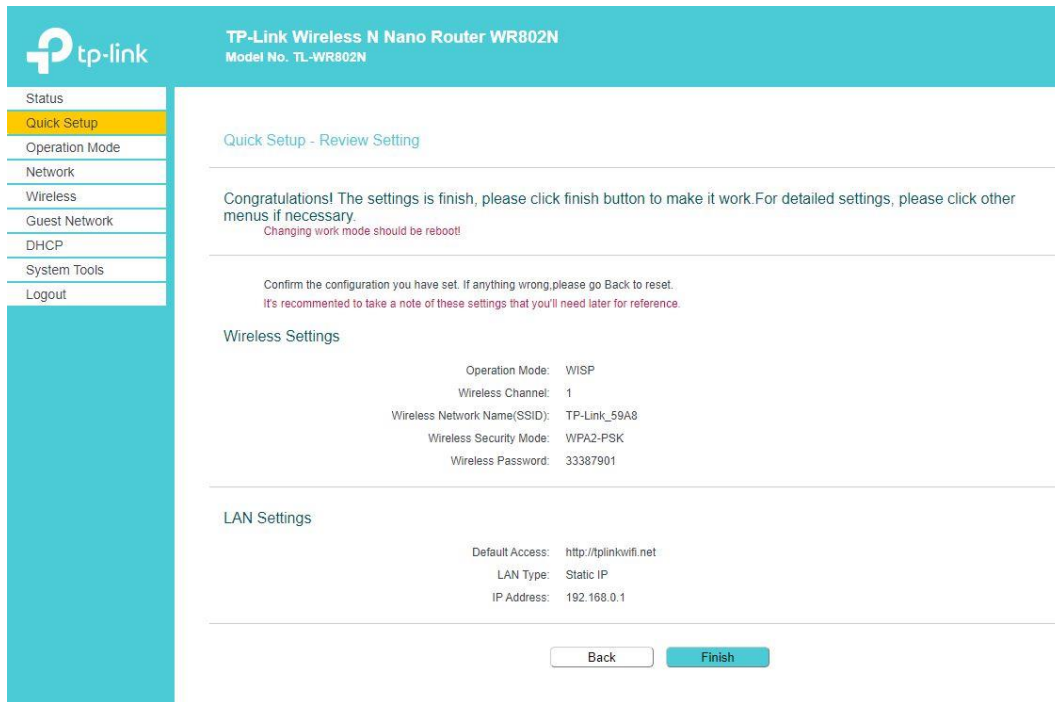

TP-Link Wireless N Nano Router WR802N
Model No. TL-WR802N

Quick Setup - Review Setting

Congratulations! The settings is finish, please click finish button to make it work. For detailed settings, please click other menus if necessary.
 Changing work mode should be reboot!

Confirm the configuration you have set. If anything wrong, please go Back to reset.
 It's recommended to take a note of these settings that you'll need later for reference.

Wireless Settings

Operation Mode: WISP
 Wireless Channel: 1
 Wireless Network Name(SSID): TP-Link_59A8
 Wireless Security Mode: WPA2-PSK
 Wireless Password: 33387901

LAN Settings

Default Access: http://tplinkwifi.net
 LAN Type: Static IP
 IP Address: 192.168.0.1

Back Finish

Confirm the following message by clicking → **OK**.



The settings will be saved, and the system will restart (rebooting).

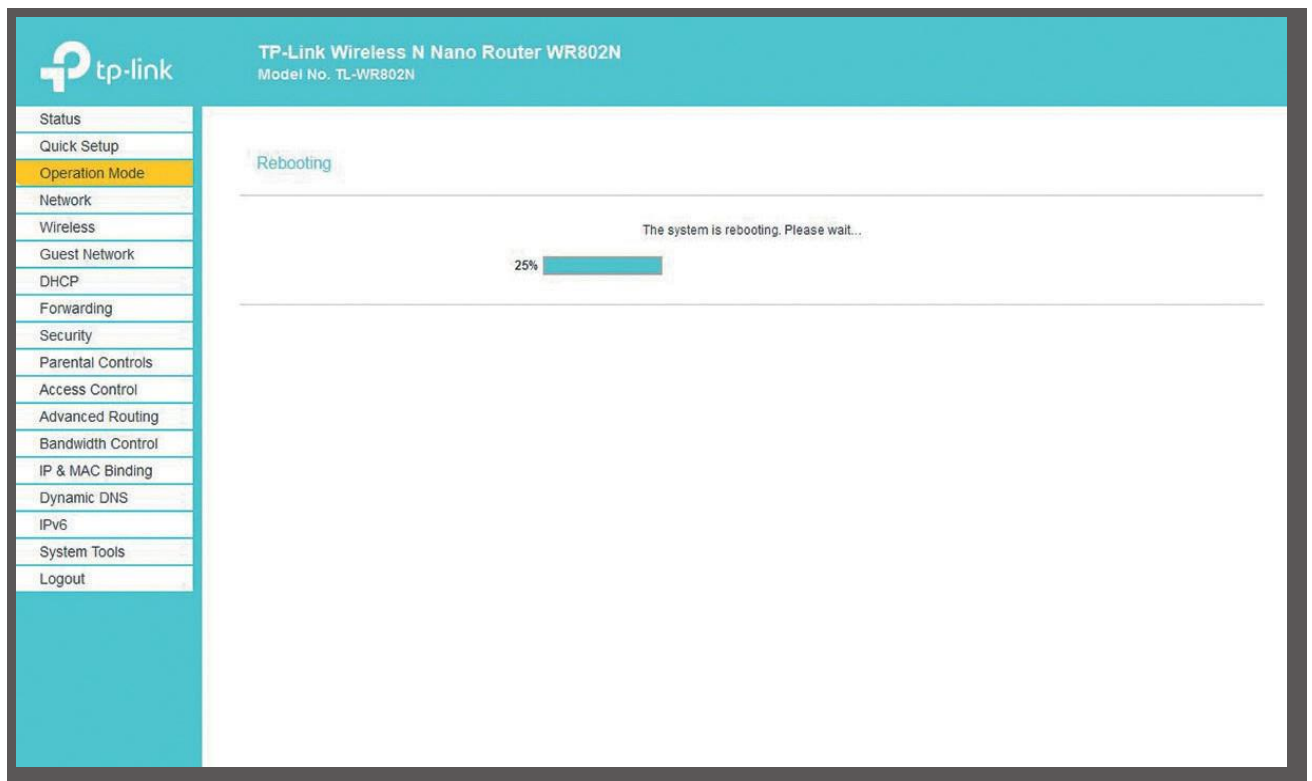

The status display shows the progress of the reboot.

Important note: It is possible that the connection from the computer to the TP-link will be interrupted during the reboot. Connect them by clicking → **Connect**.

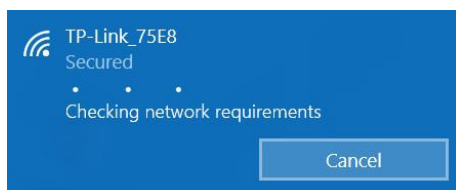

The status screen will open once the reboot is done. You can read different values for the status of the LAN and WiFi connection here.

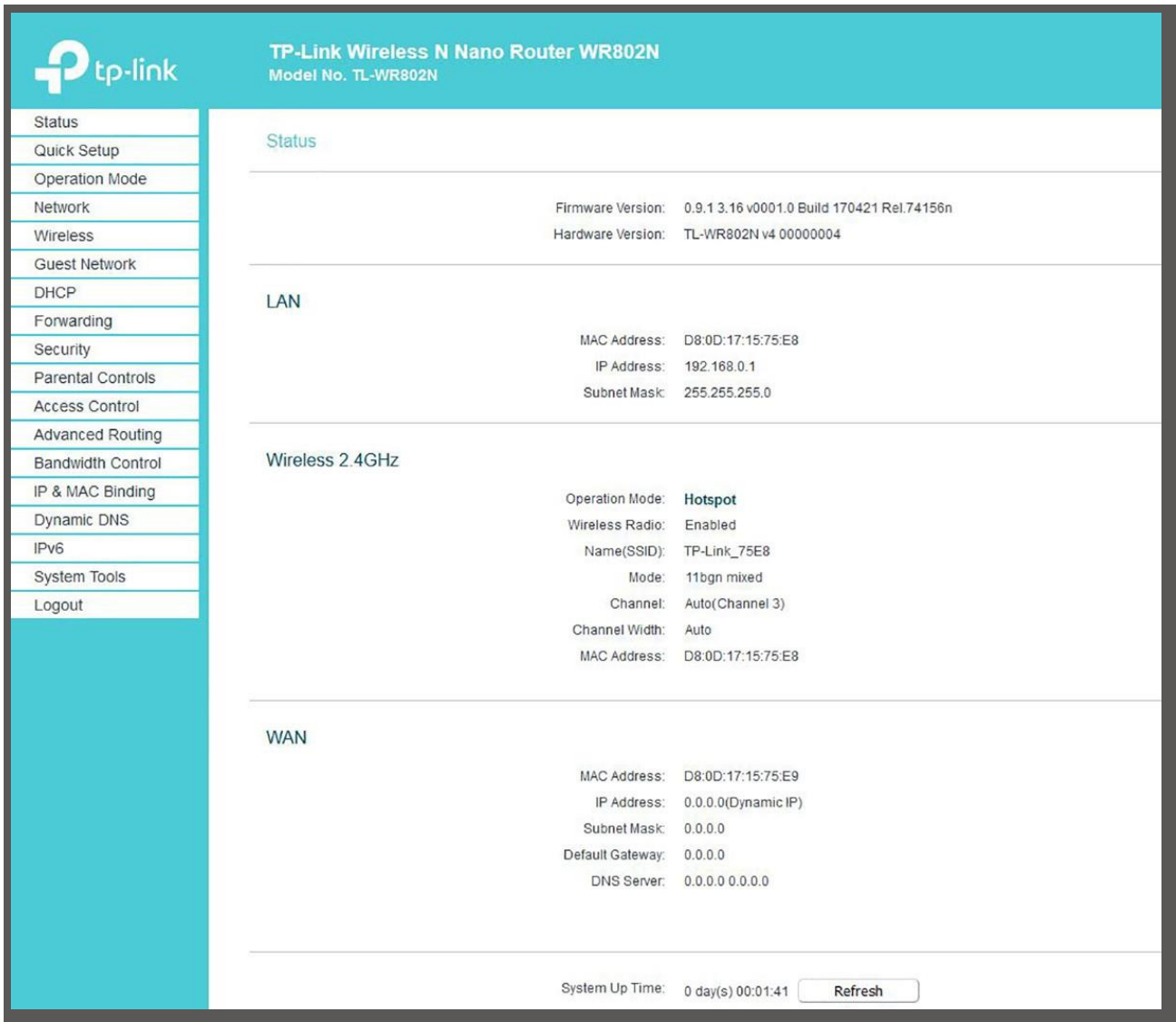

TP-Link Wireless N Nano Router WR802N
Model No. TL-WR802N

Status

Firmware Version: 0.9.1 3.16 v0001.0 Build 170421 Rel.74156n
Hardware Version: TL-WR802N v4 00000004

LAN

MAC Address: D8:0D:17:15:75:E8
IP Address: 192.168.0.1
Subnet Mask: 255.255.255.0

Wireless 2.4GHz

Operation Mode: **Hotspot**
Wireless Radio: Enabled
Name(SSID): TP-Link_75E8
Mode: 11bgn mixed
Channel: Auto(Channel 3)
Channel Width: Auto
MAC Address: D8:0D:17:15:75:E8

WAN

MAC Address: D8:0D:17:15:75:E9
IP Address: 0.0.0.0(Dynamic IP)
Subnet Mask: 0.0.0.0
Default Gateway: 0.0.0.0
DNS Server: 0.0.0.0 0.0.0.0

System Up Time: 0 day(s) 00:01:41

Then, set the IP address of the nano Router on **LAN** and for **DHCP**.
 To do so, select → **Network** in the menu at left and then → **LAN**. Assign the TP-Link the
 → **IP address 192.168.0.252** with the → **Subnet Mask 255.255.255.0**.

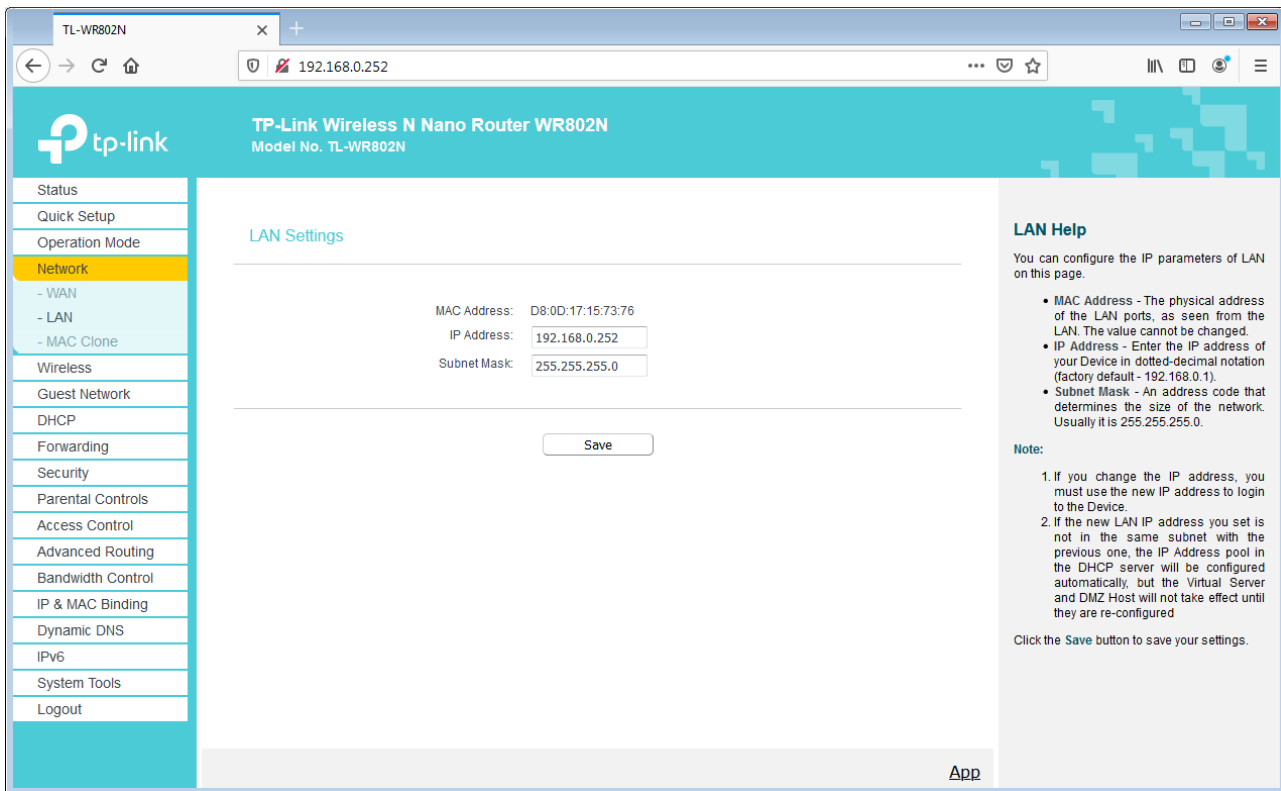

Then, activate → **DHCP** by clicking → **Enable** and change the settings displayed here for the IP addresses. Accept these settings with → **Save**.

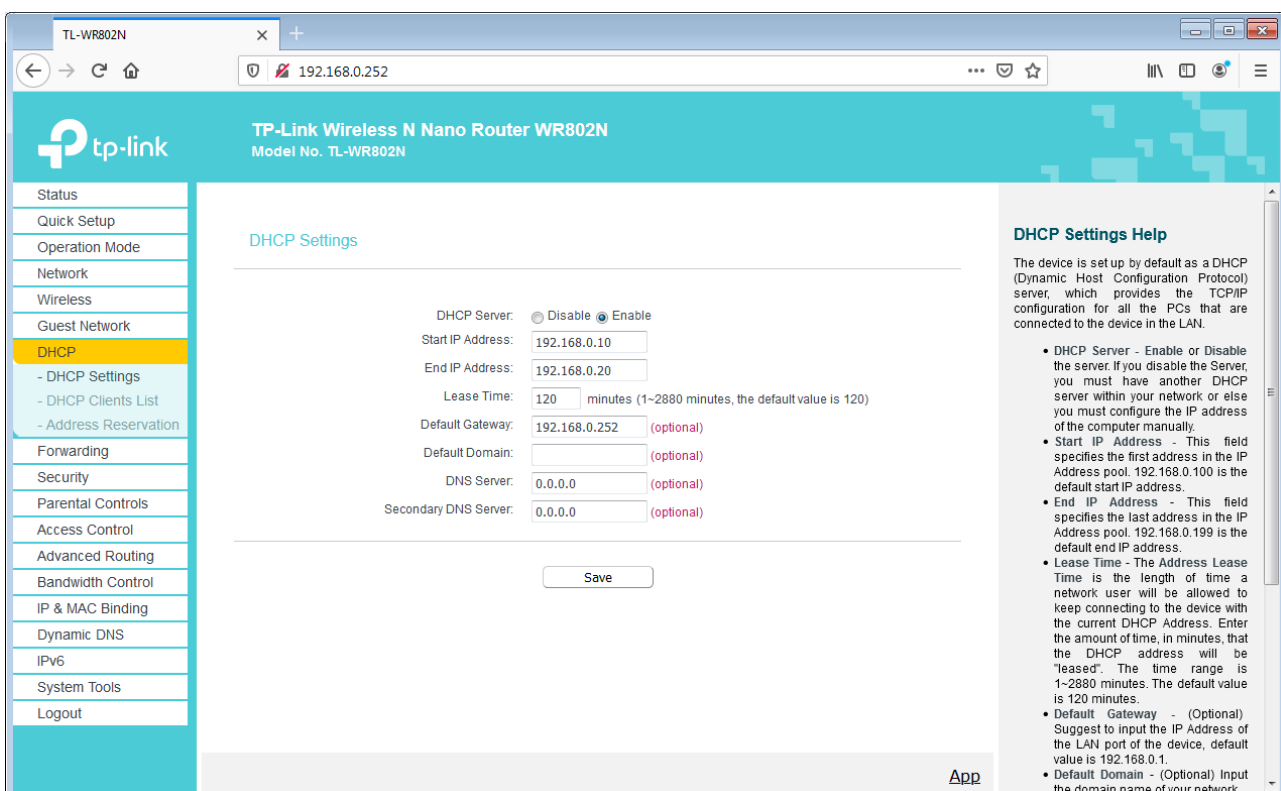

Once the TXT controller is switched on, it will be displayed in the → **DHCP Clients List** with its **MAC** and **IP address**. If it is not, turn on the TXT controller, wait until it has started up, and then update the view by clicking → **Refresh**.

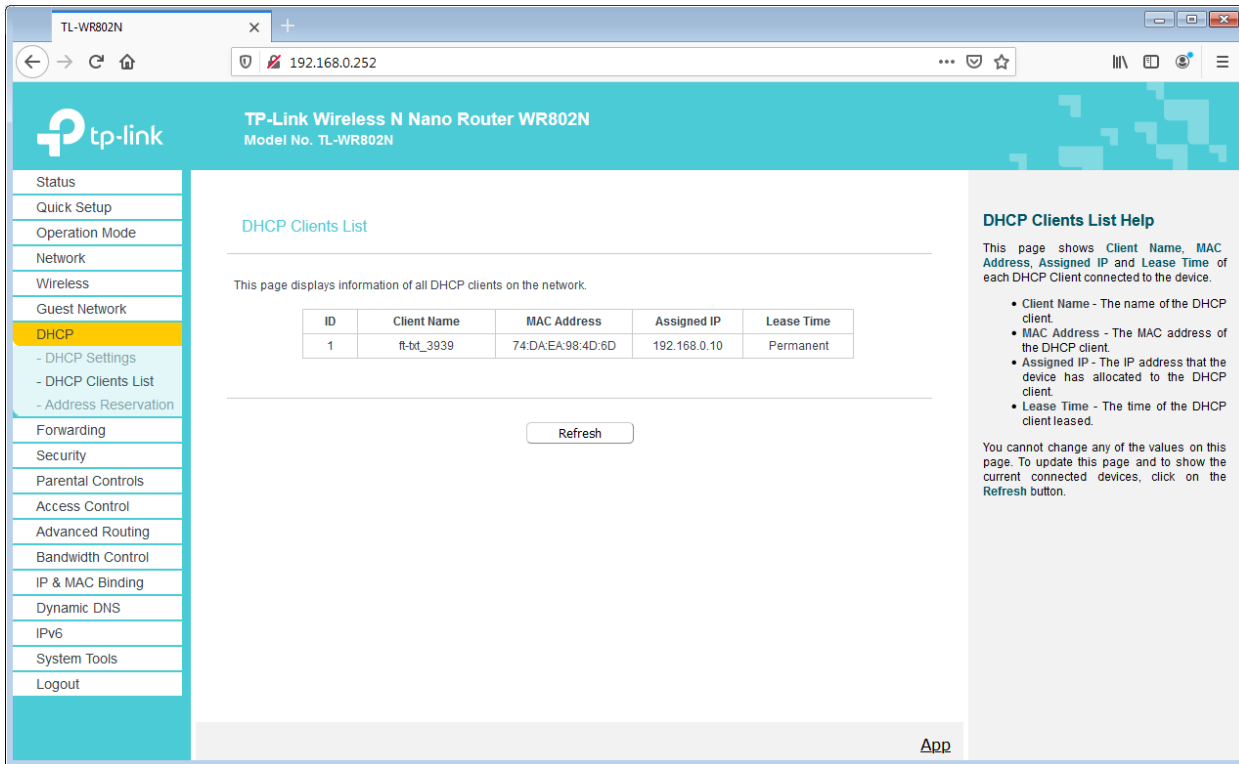

The TXT controller should have a fixed IP address of 192.168.0.10. In the → **Address Reservation** menu, this address can be re-assigned under → **Edit** and then adopted by clicking → **Save**.

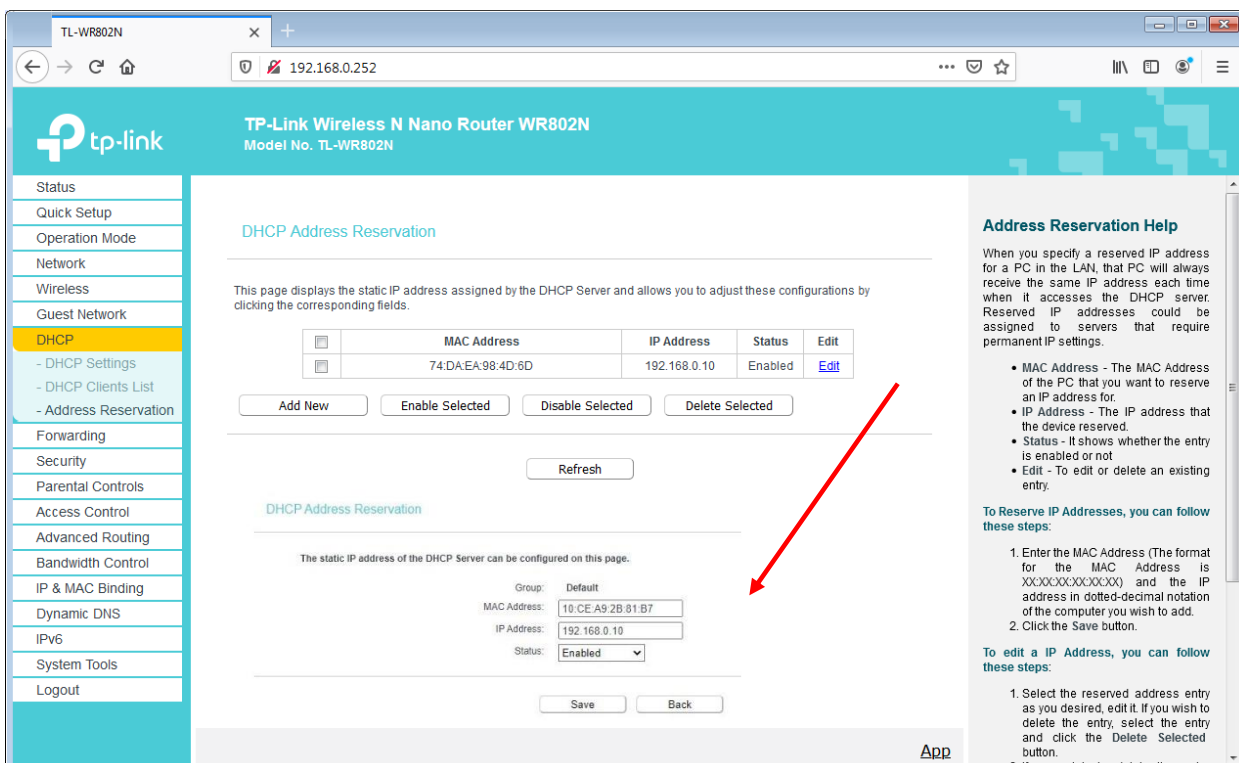

Now, you can unplug the WiFi connection to the nano Router TP link.

Training Factory Industry 4.0 dashboard in the fischertechnik cloud

The dashboard can be accessed and operated via mobile devices such as tablets and smartphones as well as laptops and PCs. It enables factory scenarios to be displayed from three different perspectives:

Customer view



Supplier view

Production view

User login

You have to log in before you can use the dashboard.
To log in, call up

www.fischertechnik-cloud.com

. The two best Internet browsers to use are “Firefox” or “Google Chrome”.
Enter the address (URL). It will now appear on the following screen.

Log in at fischertechnik

New at fischertechnik? Register now ...

Forgot password?

Important: If this page doesn't load, press “CTRL + F5” at the same time to reload the page. This is a general browser problem.

Click "here" to log in for the first time:

Are you new to fischertechnik? Sign up now...

Fill out all fields and accept the data privacy policies. Check the box, "I am not a robot" and answer the questions.

Confirm log-in by clicking:



After signing up, you will be able to log in using your user name and password. As soon as you have done this, the dashboard will start up. After carrying out the next item, the dashboard will populate with data.

Cloud connection

Only one TXT controller will link from the Training Factory Industry 4.04.0 to the cloud, which also controls the movable camera. The WiFi connection to the nano Router TP-link is a default setting.

The following settings are required for this TXT to connect to the fischertechnik cloud:

On the TXT, activate the "Settings – Properties – Cloud Client". Now click on the "Home" button to return to the "Home" screen.

Join fischertechnik

User name

Password

Repeat password

Birthday

E-mail

Parent E-mail

By registering I agree to the privacy policy.

I'm not a robot 

Privacy Terms

Register

Already have an account? Log in ...

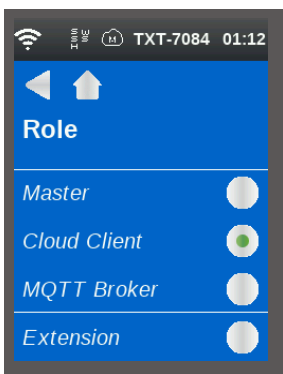

Now connect the TXT controller to the fischertechnik cloud using "Settings – Network – Cloud Settings – Pairing New".

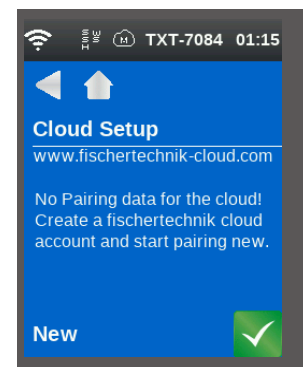



If the TXT controller is able to connect to the cloud, then a QR-code and pairing code will display. You now have 30 minutes to add your TXT controller to your account in the cloud. If this period of time elapses before you have done this, you will have to start all over with the pairing process.

You can scan the QR code, e.g., by using the “Quick Scan” app, whereupon you will be automatically directed to the fischertechnik cloud.

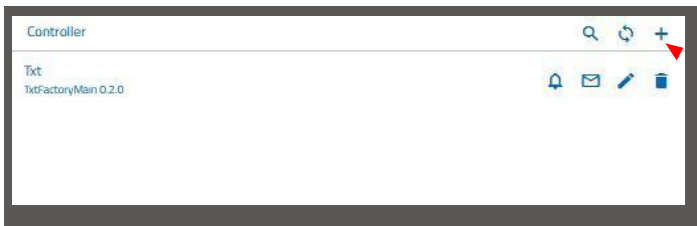

Alternatively, you can go to the fischertechnik cloud page to “Settings - Add controller” and manually enter the pairing code there.

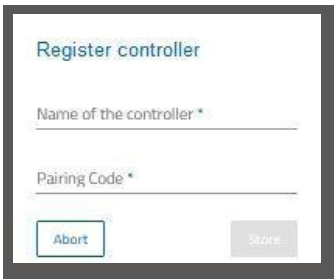

At this point enter any name you wish for the TXT controller, e.g., its ID, “TXT-7133”.

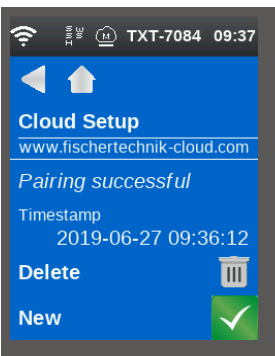

Now the TXT controller is connected to the cloud. Under “**File - Cloud**”, load the application **TxtGatewayPLC to the TXT Controller.**



As soon as you have connected to the cloud, start the applications on the TXT controller.

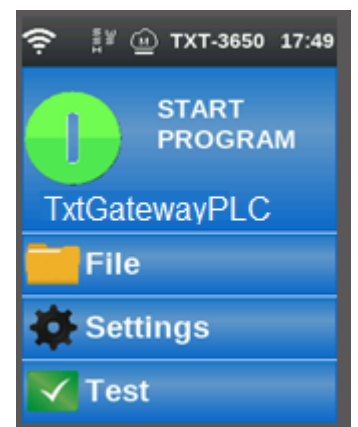

Factory dashboard

This will display with the following screen:

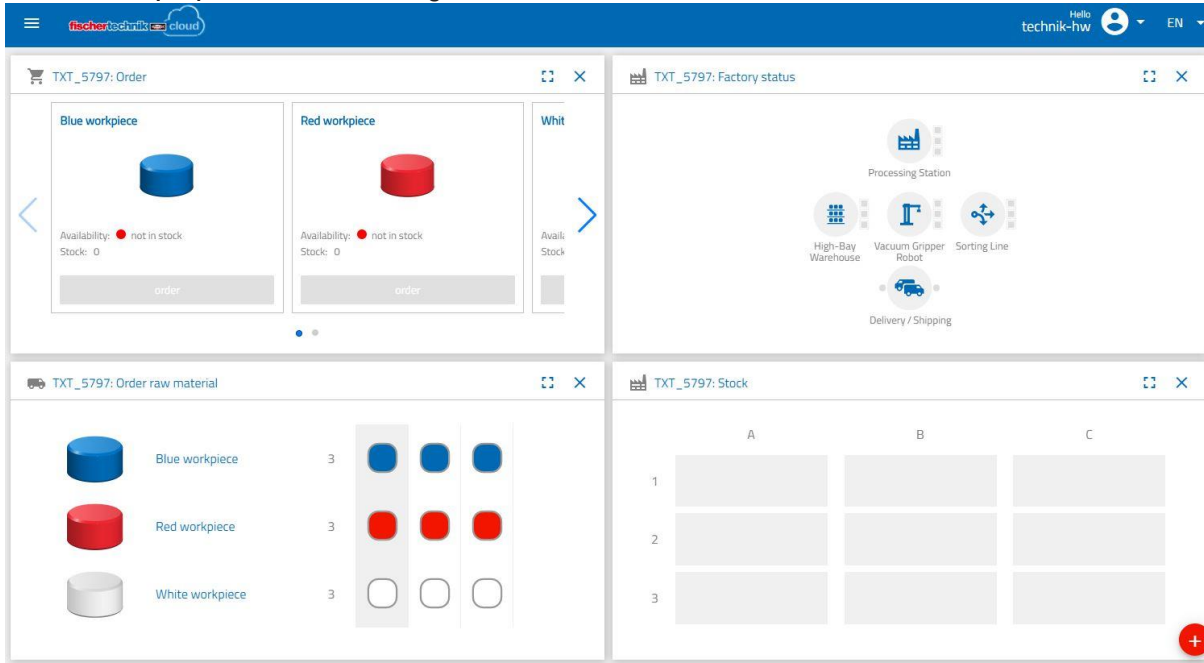

The screenshot shows a dashboard with four main panels:

- Order Panel (TXT_5797: Order):** Displays three workpiece types: Blue, Red, and White. Each has a visual representation (cylinder), availability status (not in stock), and stock count (0). There are 'order' buttons for each.
- Factory Status Panel (TXT_5797: Factory status):** A circular diagram showing the production flow: High-Bay Warehouse → Processing Station → Vacuum Gripper Robot → Sorting Line → Delivery / Shipping.
- Order Raw Material Panel (TXT_5797: Order raw material):** Shows a visual inventory of 3 blue, 3 red, and 3 white workpieces.
- Stock Panel (TXT_5797: Stock):** A 3x3 grid table with columns A, B, C and rows 1, 2, 3.

You can change the sequence of the individual screens to adjust your requirements.

Click this button to close or expand the main menu for the cloud.

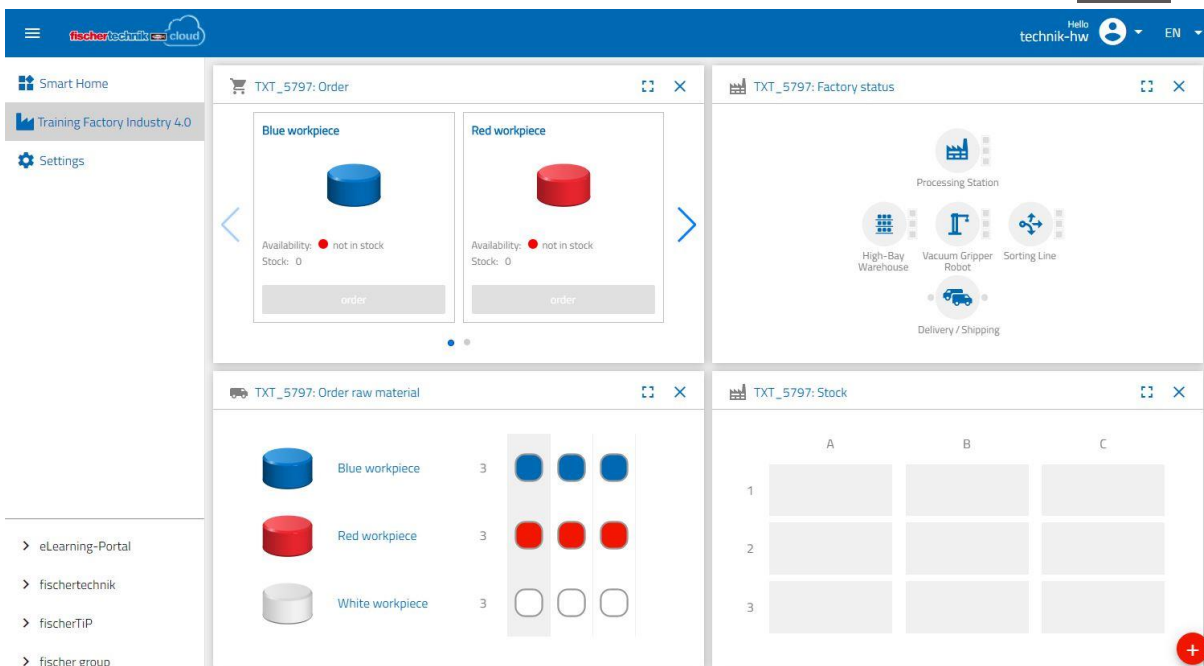
This screenshot shows the same dashboard as above, but with a main menu expanded on the left side:

- Smart Home**
- Training Factory Industry 4.0**
- Settings**
- eLearning-Portal**
- fischertechnik**
- fischerTIP**
- fischer group**

The individual windows and their functions at a glance:

Order raw material

The **“Order raw material”** view: The view indicates which raw material is missing and needs to be reordered.

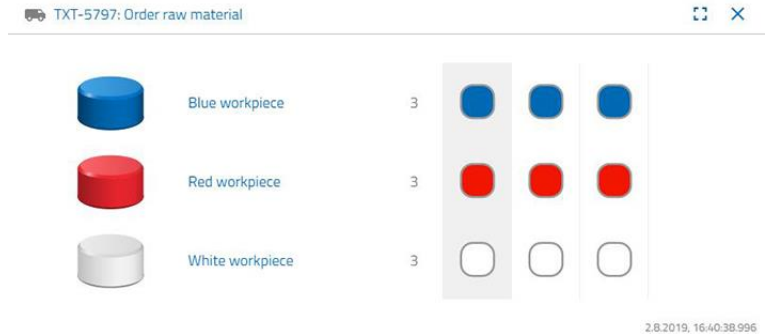

Inventory

You can see how many raw materials were stored in the high-bay warehouse in the **“Inventory”** window. The stock is changed according to the number and colour if goods are removed.



Order

This window shows how much raw material (blue, red, white) is in the warehouse. If, for example, a red workpiece is placed on the shelf, the colour display and stock value changes.

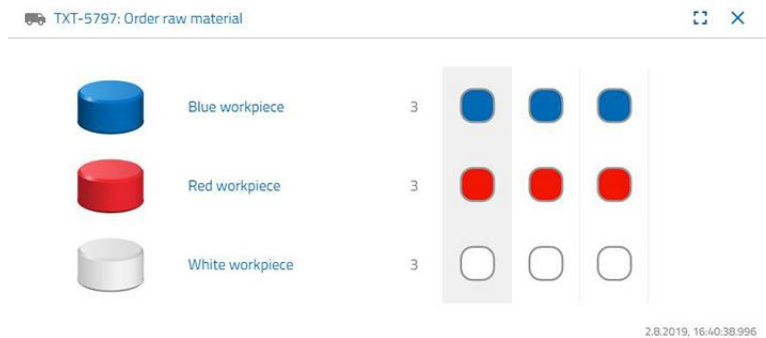

Factory status

The current working status of the overall factory is displayed in the **“Factory status”** window. “Icon is highlighted in blue” will be displayed if, for example, the vacuum suction gripper is currently being used.

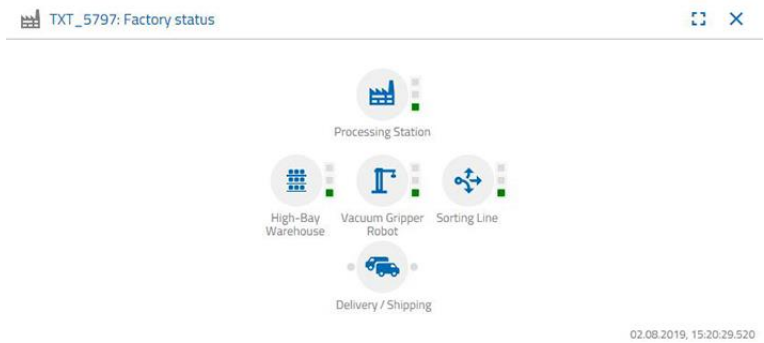

Production status

In this window, you see the blueprint of the production process right after you have ordered a workpiece. This allows you to keep track of where the workpiece currently is in the factory.



The NFC reader

This window always displays the NFC reader’s current status.

But you can also hang a workpiece and read out the data of the NFC tag.

Click **“Delete”** to delete the contents on the NFC tag.

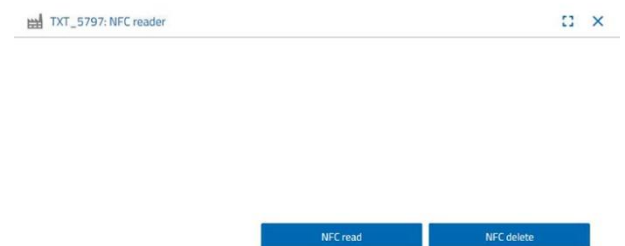

Dashboard camera

Camera

The **"Camera"** screen displays the camera section of your factory.

This corresponds to a live recording of the factory.



Camera control

This screen gives you the power to control your camera live. You can thus get an overview of the entire factory.

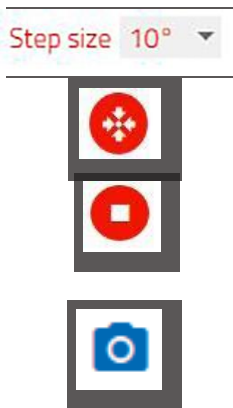
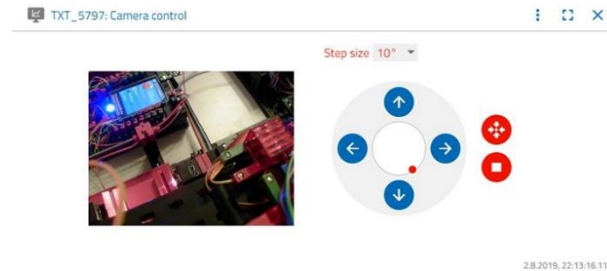

Control the camera

with the virtual joystick. The red dot indicates where the centre of the camera is. Use the **"Step size"** button to set the degree by which the camera rotates when the arrow is clicked. The two red buttons can be used to centre or stop the camera.

Take a snapshot

The **"Snapshot for the Current Image"** button lets you place the current image in the Gallery screen.

Gallery

All the images you have created are saved in the **"Gallery"** window. Use the arrow keys to scroll through the gallery. The current picture is displayed zoomed. Click **"Delete"** to remove an image from the gallery.

Use the command **"Download"** to store the image for further use. Specify a storage location in the context menu that opens.



Dashboard Environmental Station

In addition to the camera function, you can view and process the information from the environmental sensor.

Current air quality



The **"Current air quality"** window lets you see a value of the air quality, which is indicated by the three rectangles. The displays will be switched on depending on the quality of the air when it is measured. Green means that the air quality is very good; green and yellow indicate that it is good; yellow means satisfactory; yellow and red signify that the air quality is adequate and red means that the air quality is bad.

The **"More"** button (this applies to all environmental sensor windows) let's you choose between **"Graph"**, **"Single value"** and **"Download"**.



You will get a graphical representation of the measured values if you select **"Graph"**. Use the scroll bar to scroll through all recorded data.



| | date:time | indoor | air | quality:iaq | accuracy |
|---|-----------------|--------|-----|-------------|----------|
| 7 | 5 2019;17:07:30 | 63,0 | | | |
| 7 | 5 2019;17:08:30 | 81,0 | | | |
| 7 | 5 2019;17:12:26 | 63,0 | | | |
| 7 | 5 2019;17:13:40 | 63,0 | | | |
| 7 | 5 2019;17:14:40 | 80,0 | | | |
| 7 | 5 2019;17:17:05 | 63,0 | | | |
| 7 | 5 2019;17:18:05 | 76,0 | | | |
| 7 | 5 2019;17:19:05 | 110,0 | | | |
| 7 | 5 2019;17:20:38 | 195,0 | | | |
| 7 | 5 2019;17:21:38 | 287,0 | | | |
| 7 | 5 2019;17:22:38 | 288,2 | | | |

If you select **"Download"**, the data will be downloaded as a .csv file and can be downloaded and displayed in OpenOffice Calc or Excel. The data can then be further processed.

Current brightness

The **"Current brightness"** window displays a brightness value in %, as well as the time at which the measured value was taken. Also visible are the brightness variations.

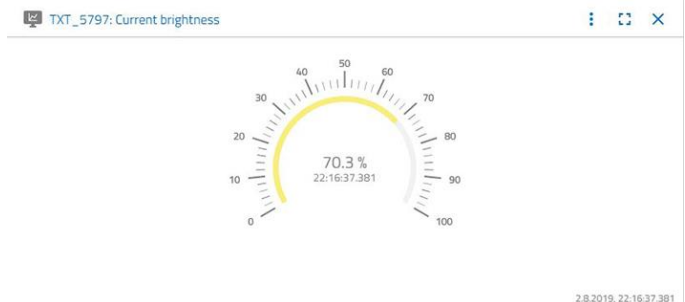

Current air pressure

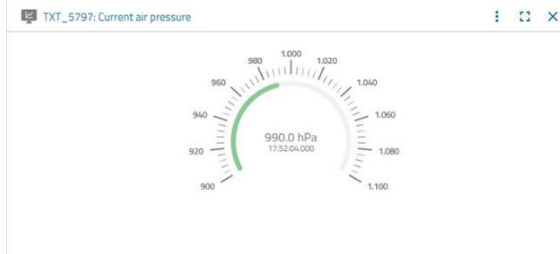

The **"Current air pressure"** window displays the air pressure in hPa (Hecto-Pascal) and the time at which the measured value was generated.

Current humidity

The **"Current humidity"** window displays a value for relative humidity as a %.



Current temperature

The **"Current temperature"** window displays the current temperature (ambient temperature) of the measuring sensor in ° C.

Other buttons



Use the **"Add window"** button to add a hidden window. If you activate the button, a context menu appears from which you can show a dashboard window.



Use this button to shoot the current window.



Use this button to zoom the current window to full screen mode.

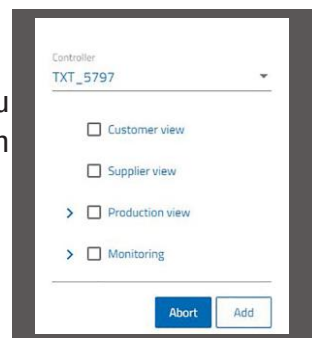

This button shows and hides the left status bar.



The button shows which profile you are logged in under. Clicking on the arrow will bring up a context menu. Here, you can select **"Profiles"** or **"Logout"**. Selecting **"Profiles"** will open another context menu in which you can set settings for your profile. Click **"Logout"** to log out of the fischertechnik cloud.

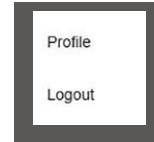

A context menu for selecting the language will display if you activate the arrow that comes after **"DE"**.



The status bar shows three selections that you can activate by clicking on them. The first two buttons let you choose whether you want to work with the factory simulation dashboard or just the environmental station dashboard.



Activating the **"Settings"** button will display a context menu where you can view and change various parameters relating to your TXT controller.

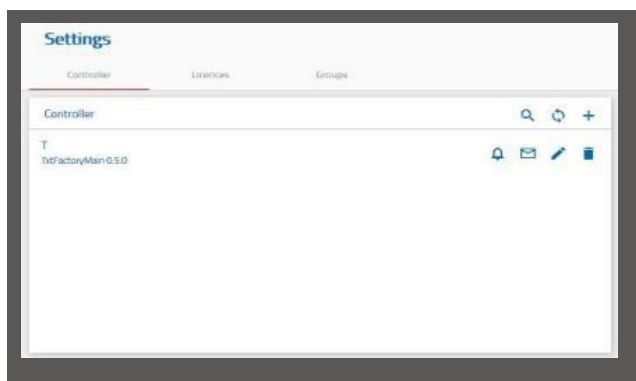

Operating the factory with the fischertechnik cloud



To start factory operation, first load the PLC program and then set CPU1512SP to RUN.

This is described in the section **Commissioning and adapting the SIMATIC controller CPU1512SP**.

Then start the application on the TXT controller as described here:



When the TXT controller is switched on, the program is loaded automatically by "Auto Load," and just needs to be started by pressing "**Start Program**" on the touch display.

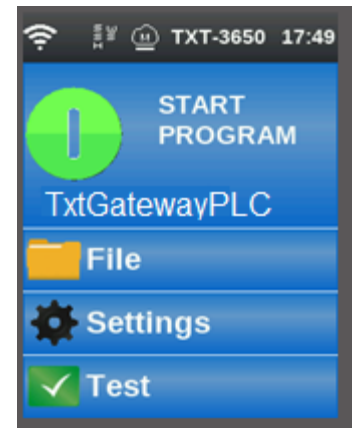

The following application will run on the TXT Controller:

"TxtGatewayPLC"

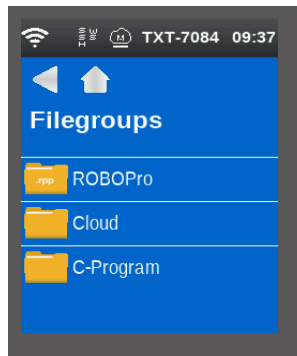

This application is on the TXT Controller under:
File - Cloud



Control at end: The program on the TXT Controller must run. This is recognizable by the red symbol on the controller display.

Then the IOT gateway should be restarted. Do so using the "**fischertechnik Node RED Dashboard**". In the "**HMI – Main**" view, click  in the "**Factory Control via OPCUA**" window to easily switch the power supply on and off.

Once the programs on the PLC, the IOT gateway and the TXT Controller are started, the Training Factory Industry 4.04.0 will be ready for operation.

You will learn to operate the factory and the dashboard by carrying out the following tasks.

Task 1

Before raw material can be stored in the high-bay warehouse, the compartments must be equipped with the supplied empty containers. This is the first task you need to perform as a warehouseman.

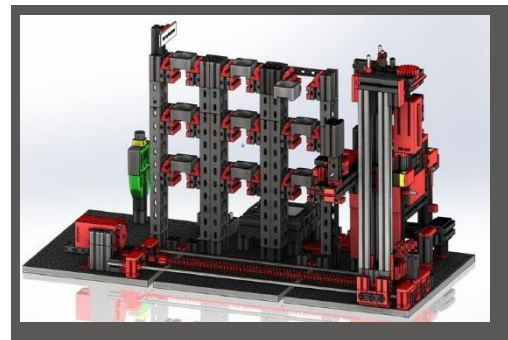
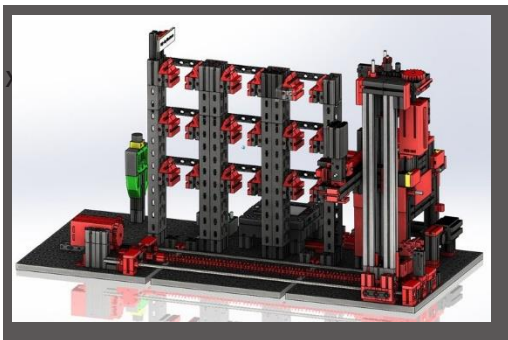

Your dashboard looks like this:

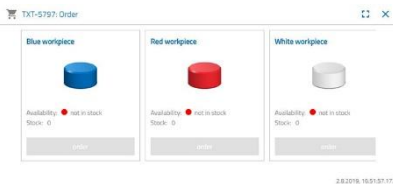

Purchase order

Blue, red, white not available, stock 0

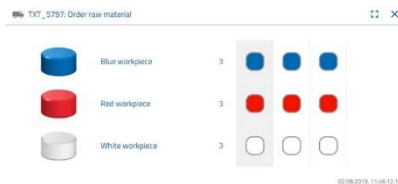

Raw materials order

No order placed



Inventory

Inventory empty, since no raw materials were stored



Important note: If this is not the case, you can use the included key fob (with integrated NFC tag) to reset the dashboard windows to their default settings. Alternatively, you can also use the Node-RED dashboard



Task 2

Order raw material that should be stored in the high-bay warehouse as stock. To do this, manually store the raw material in the input station.

First, only store a white stone as a workpiece.



Enter a white stone in the material input. The workpiece (raw material) interrupts the photoelectric barrier. This process is identified as "Inbound Delivery" and highlighted in green in the "Production Process" dashboard window with the "Delivery" icon.

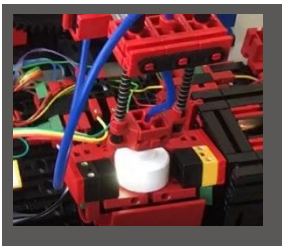

Then the vacuum suction gripper moves to the storage position, picks up the raw material and moves it to the NFC reader.

The dashboard window displays the process as follows:



Delivery and vacuum suction grippers are active and are displayed in green.

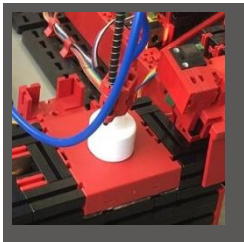

At this point, all data is deleted that is located on the NFC tag for the raw material (already described).

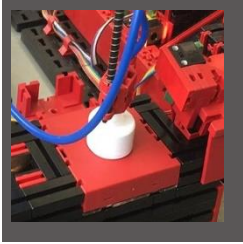

The raw material colour is determined in the next step. To do this, the vacuum suction gripper moves the raw material over the colour sensor. The data is then available to the NFC reader for further processing. Before the raw material is stored, the determined colour data and further



information such as delivery data and quality controlling data are written on the NFC tag using the NFC reader. Since both factory modules (delivery and vacuum pads) are still active, this will continue to be displayed in green on the production process dashboard.

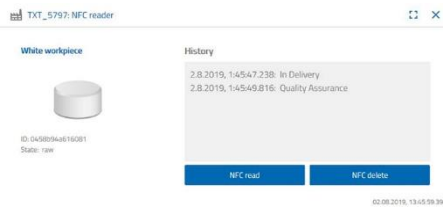

This data is displayed in the "NFC Reader" dashboard window.

What happens next?

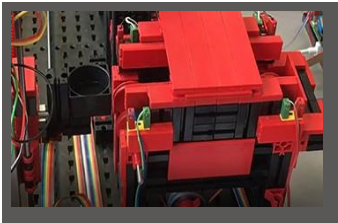

The high-bay warehouse provides an empty container to hold the raw materials. For the raw material to be placed in the empty container, the gripper arm moves into the position for an empty container, picks it up with its slider and deposits it on the input/output device.



The container is transported via container to the input position.



The vacuum suction arm rotates to the discharge position, moves down and places the raw material into the waiting container.

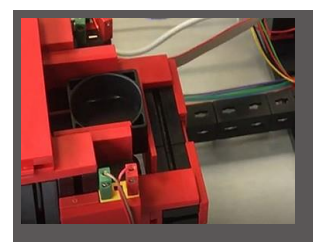

The input/output device then transports the container with the raw material to the high-bay warehouse gripper arm's receiving position. At this point, the container is picked up, transported to the storage location in the high bay and stored there.

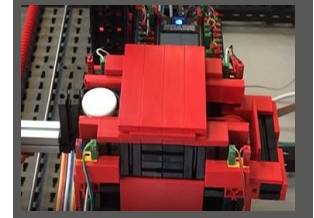

The "Production process" dashboard window shows the next steps in the storage process. The icons for all active factory modules light up in green when the factory modules are in action.



Look at the following dashboard window - TXT: Order raw material, TXT: Inventory and TXT: Order.

TXT: Order raw material

There are 3 workpieces available for ordering raw materials. The maximum number of white stones will be reduced by one in the "TXT: order raw materials" dashboard window. After you have done this, you will still have two workpieces available for storing.

TXT_5797: Order raw material

Blue workpiece 3

Red workpiece 3

White workpiece 2

TXT: Inventory

You will now see a white stone displayed in the storage system in the "TXT: Inventory status" dashboard window This means that you can order this workpiece as a customer and have it processed.

TXT_5797: Stock

| | A | B | C |
|---|---|---|---|
| 1 | | | |
| 2 | | | |
| 3 | | | |

02.08.2019, 13:39:05.802

TXT: Purchase order

The dashboard window "TXT: Order" will now be displayed, showing that there is a white stone in the warehouse and it can be ordered.



TXT_5797: Order

| Blue workpiece | Red workpiece | White workpiece |
|---|---|---|
| | | |
| Availability: ● not in stock | Availability: ● not in stock | Availability: ● in stock |
| Stock: 0 | Stock: 0 | Stock: 1 |
| order | order | order |

02.08.2019, 13:39:37.374

Task 3

Order raw material that is to be stored in the high-bay warehouse as stock. To do this, manually store the raw material in the input station.

Now store a blue stone as a workpiece.

As described in Task 2, insert a blue stone in the high-bay warehouse. The dashboard will display the results once the foot-away work has been accomplished.

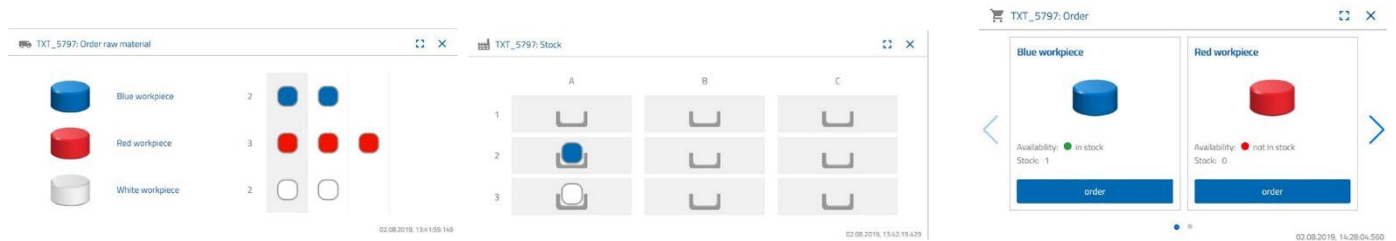

Task 4

Store additional raw materials for storage in the high-bay warehouse. You still need two white and one red workpieces.

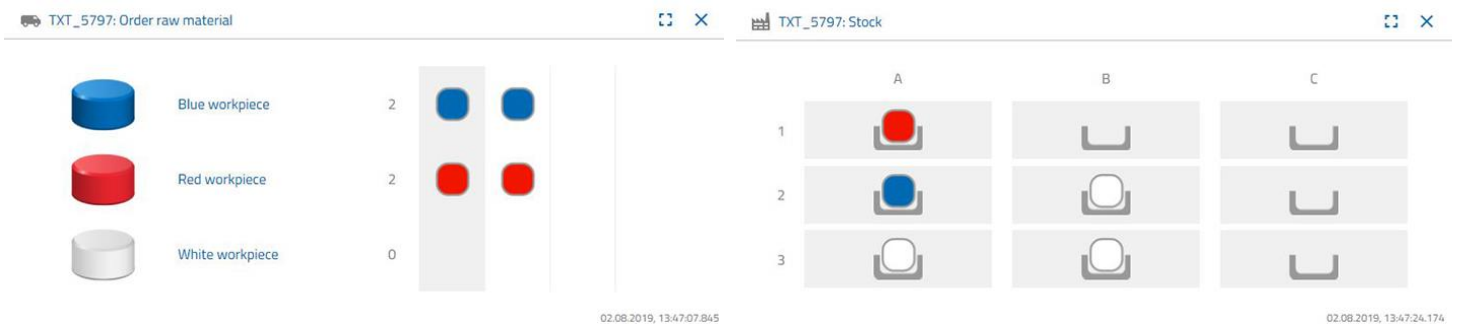

Task 5

Put yourself in the position of a customer, who, for example, would like to order a white workpiece. Order a white workpiece.

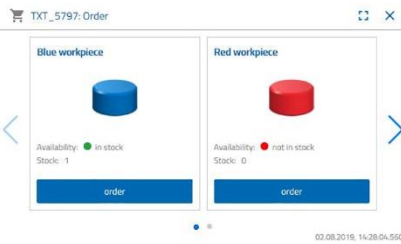

To do this, click on the blue “Purchase order” button in the “TXT: PO” dashboard window.

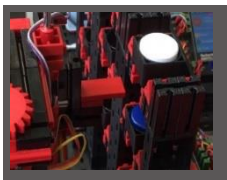
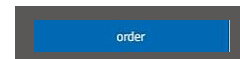

This happens at the factory: The transport arm of the high-bay warehouse moves into the “white workpiece” insert position.



The transport arm picks this up and put it in the high-bay warehouse’s in-/output station. From there, it is transported to the receiving position on the vacuum suction gripper.

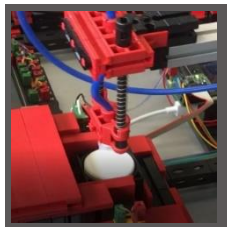

The vacuum suction gripper picks up the workpiece at the picking position and places it on the slider in the kiln.

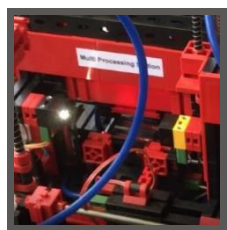

The workpiece is inserted, fired and moved out of the oven again.

The available small transport carriage with vacuum suction takes over the transport to the processing machine referred to as the “milling machine”.

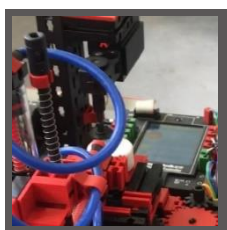

The transport carriage with vacuum suction places the part on the turntable, which then turns it to the milling machine. After the milling process has been carried out, the workpiece is rotated another 90 degrees and pneumatically pushed onto a conveyor belt.

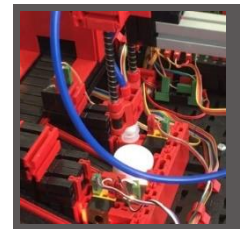

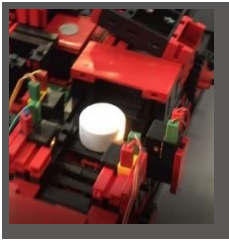

On the way to the sorting device, the workpiece undergoes colour detection.

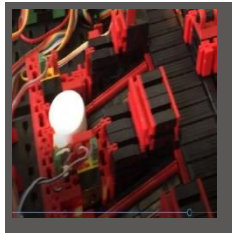

Depending on the detected colour, the workpiece is pushed pneumatically from the conveyor belt on a material chute. The workpiece is located in a receiving area and can be transported from here using the vacuum suction gripper.

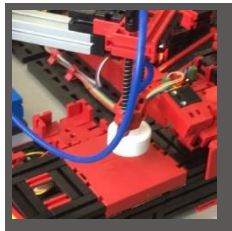

The gripper places the workpiece on the NFC reader for the final inscription. There it is loaded with workpiece-related data such as the order date, manufacturing or delivery data.



Finally, the workpiece is placed in the output tray at the input-output station.

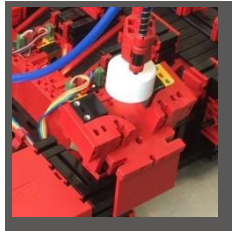
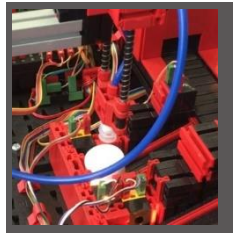
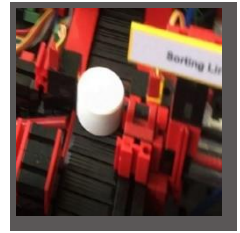

You can also follow the steps on the dashboard:

Raw material is taken from the high-bay warehouse and fed to the processing process.



Raw material is processed in the multi-processing station (kiln, milling machine).

A machined workpiece is sorted by colour and the NFC reader provides it with workpiece-relevant data.

The workpiece is ready for delivery and can be removed from the system.



Task 6

A white stone has accidentally fallen off the high bay and you want to know what data was written on the NFC tag.

The system must be at rest to do this. Place the workpiece on the NFC reader and activate the “Read NFC” button in the “TXT: NFC Reader” dashboard window.

The NFC reader reads the data and displays it in the dashboard window.

If necessary, you can delete the data using the “Delete NFC” button.

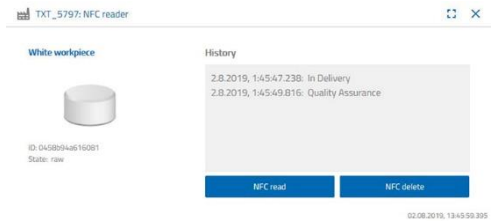

Task 7

Evaluate data from your environmental station. To do this, first show the data in the graph area of the dashboard view. Save the data as a .csv file and use it in a spreadsheet program.



Single value

Curve

 Download

Determine data on brightness of the environment in your factory.



+

Determine current temperature data for your factory and edit in a spreadsheet program.

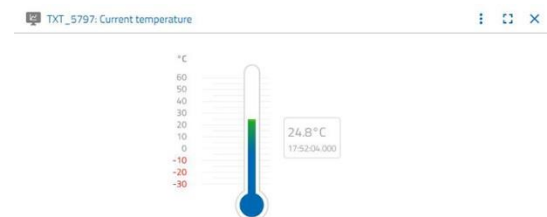

Determine the humidity values over a longer period of time and have them displayed graphically on the dashboard.

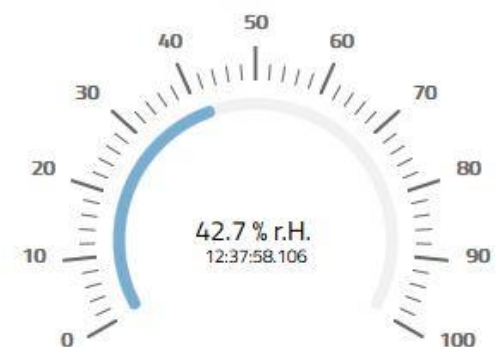

Task 8

Use the built-in camera to monitor your factory. Move the camera around your factory and take 2 pictures of the factory. Save an image for documentation. Delete unnecessary pictures from the gallery.



To move the camera, use the “TXT:

Camera control” dashboard window.

The buttons used for this task have already been explained previously in the description of the dashboard.

Move the camera around your factory. Move the vertical and horizontal axes of your camera using the “blue arrow buttons”.

The factory section that the camera is currently recording is also displayed in the “TXT: Camera” dashboard window.

Select three pictures and save them in the “TXT: Gallery” dashboard window. Use the “Take snapshot for the current image” button.

Select 1 picture from the gallery, one that you would like to further process in an image editing program. To do this, click on the “Download” button

. A context menu appears in which you specify the storage location and the file name.

Click the “Delete” button to delete unwanted pictures.

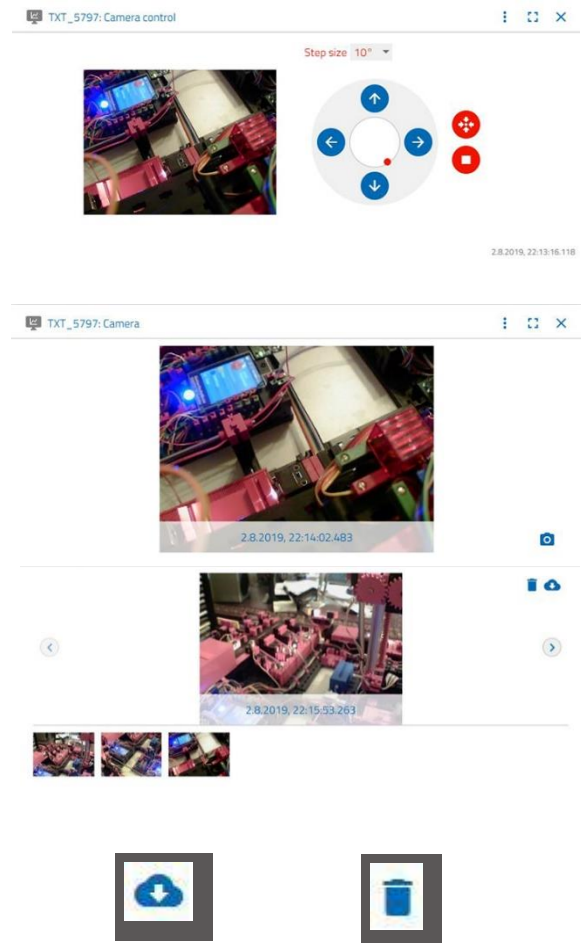

Training Factory Industry 4.0 fischertechnik Node-RED dashboard

The fischertechnik Node-RED dashboard is designed to be a local HMI operating interface (**H**uman **M**achine **I**nterface) in a local network (LAN). It can be started easily in a web browser (recommended: Firefox or Chrome) by entering:

192.168.0.5:1880/ui

(IP address of the IoT gateway: Port 1880 / ui as the name of the application)

The following views are available here:

HMI – Main

The camera image and the workpieces stored in the high-bay warehouse are displayed in this menu.

In the **“Factory Control via OPCUA”** window, you can click  to reset assignment of the high-bay warehouse.

Click  to acknowledge errors in the Training Factory Industry 4.04.0.

Click  to restart the IOT gateway. This is required when the PLC program has been restarted.

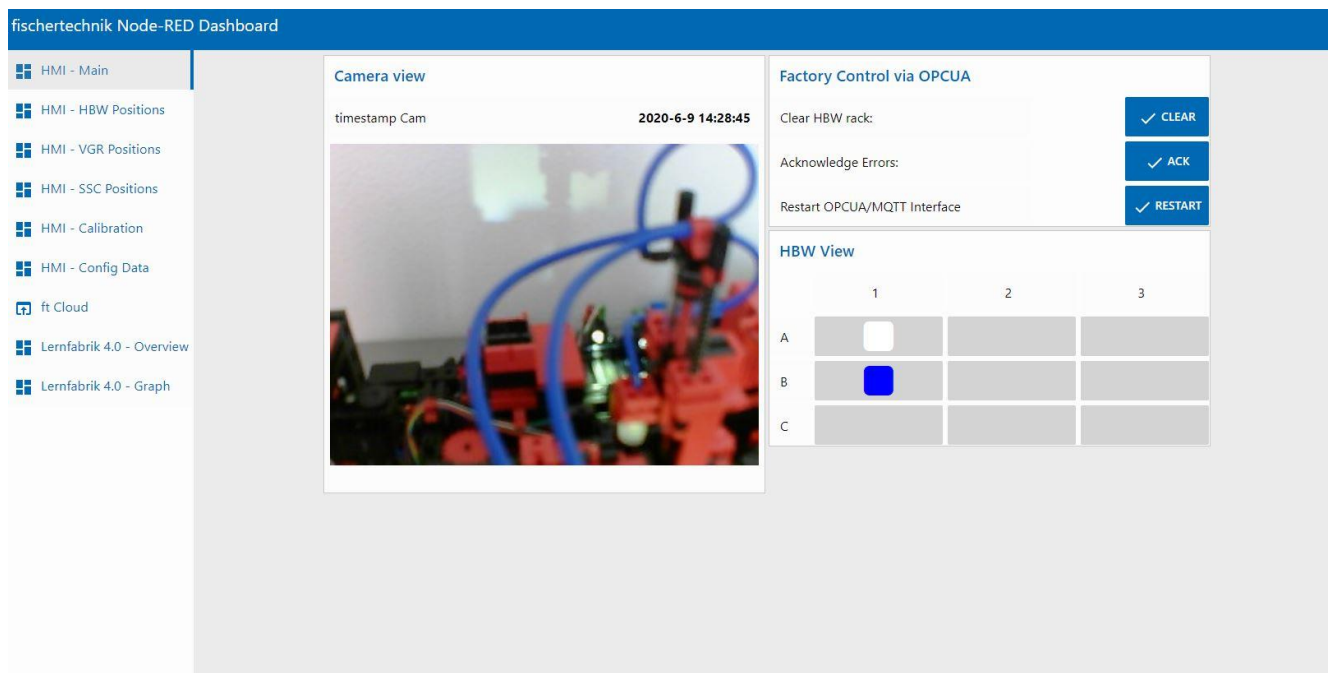

HMI – HBW Positions

The positions of the stacker crane in the automated high-bay warehouse station (HBW) can be calibrated and monitored in this menu.

fischertechnik Node-RED Dashboard

- HMI - Main
- HMI - HBW Positions
- HMI - VGR Positions
- HMI - SSC Positions
- HMI - Calibration
- HMI - Config Data
- ft Cloud
- Lernfabrik 4.0 - Overview
- Lernfabrik 4.0 - Graph

HBW

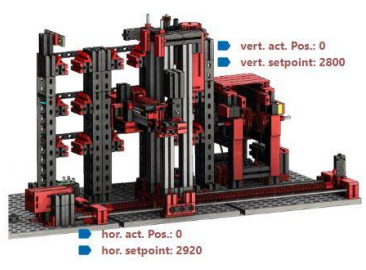

move to Position

Activate pos. move

HBW Positions: Select position

Pos. value horizontal:

Pos. value vertical:

Start positioning: ✓ START

Final positioning: ✓ FINAL

Start offset: ✓ OFFSET

Home positioning: ✓ HOME

Position Belt

horizontal:

vertical:

vertical Offset:

Position Rack

Position Rack Row A

Position Rack Row B

Position Rack Row C

HMI – VGR Positions

The positions of the 3-axis robot in the vacuum suction gripper (VGR) station can be calibrated and monitored in this menu.

fischertechnik Node-RED Dashboard

- HMI - Main
- HMI - HBW Positions
- HMI - VGR Positions
- HMI - SSC Positions
- HMI - Calibration
- HMI - Config Data
- ft Cloud
- Lernfabrik 4.0 - Overview
- Lernfabrik 4.0 - Graph

VGR

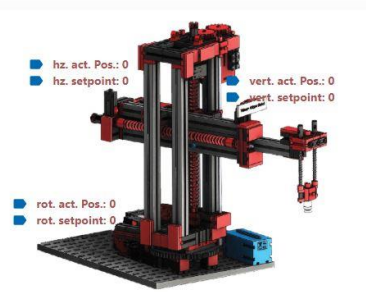

move to Position

Activate pos. move

VGR Positions: Select position

Pos. value horizontal:

Pos. value vertical:

Pos. value rotation:

Start positioning: ✓ START

Final positioning: ✓ FINAL

Start offset: ✓ OFFSET

Home positioning: ✓ HOME

Position Color Reader

horizontal:

vertical:

rotate:

Position DSI

Position DSO

Position HBW

Position MPO

Position NFC

Position NiO

Position SLD

HMI – SSC Positions

The positions of the camera in the sensor station with camera (SSC) can be calibrated and monitored in this menu.

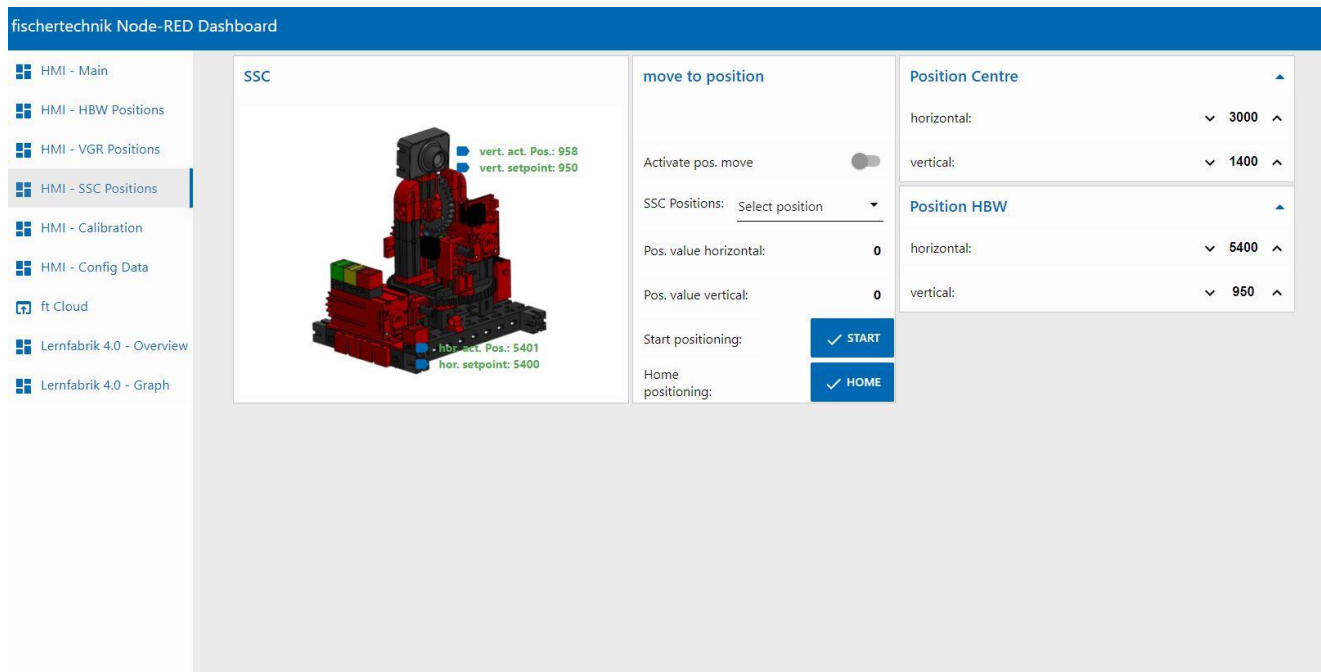

fischertechnik Node-RED Dashboard

- HMI - Main
- HMI - HBW Positions
- HMI - VGR Positions
- HMI - SSC Positions
- HMI - Calibration
- HMI - Config Data
- ft Cloud
- Lernfabrik 4.0 - Overview
- Lernfabrik 4.0 - Graph

SSC

vert. act. Pos.: 958
vert. setpoint: 950

hbw act. Pos.: 5401
hor. setpoint: 5400

move to position

Activate pos. move

SSC Positions: Select position

Pos. value horizontal: 0

Pos. value vertical: 0

Start positioning:

Home positioning:

Position Centre

horizontal: 3000

vertical: 1400

Position HBW

horizontal: 5400

vertical: 950

HMI - Calibration

The colour sensors in the sensor station with camera (SSC) and the colour sensor and positions on the sorting line with colour detection (SLD) can be calibrated in this menu.

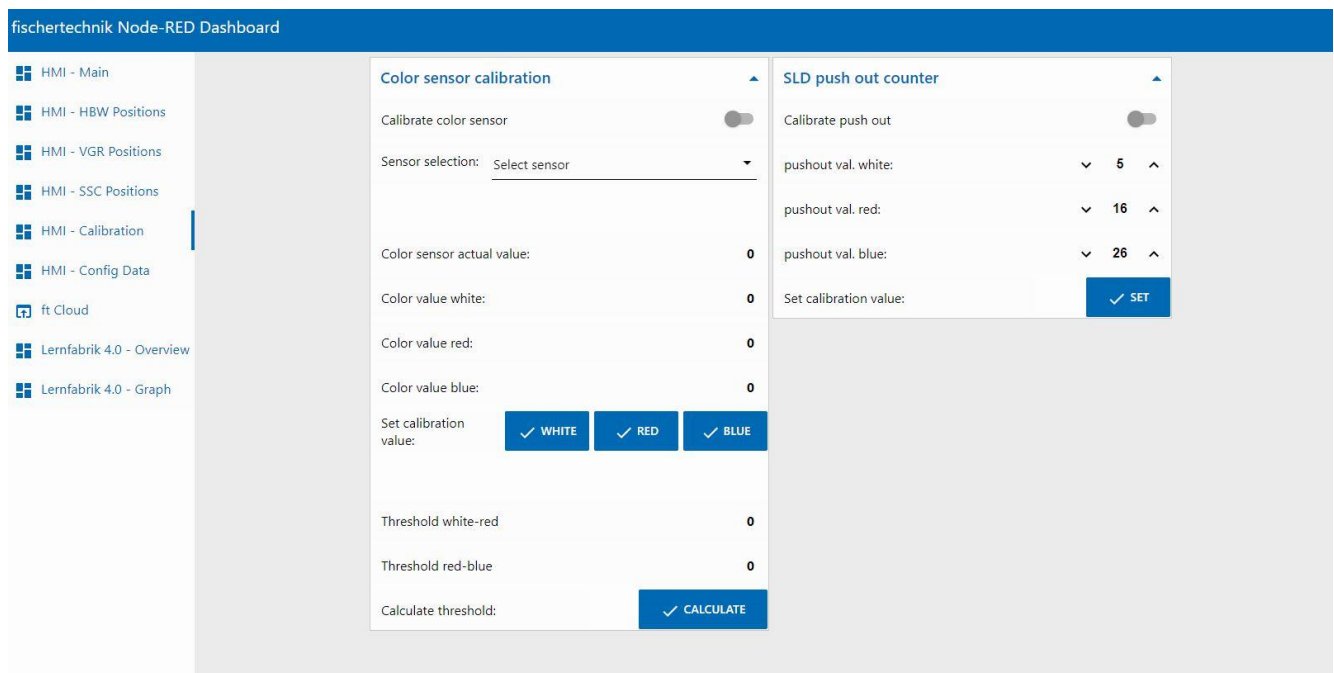

fischertechnik Node-RED Dashboard

- HMI - Main
- HMI - HBW Positions
- HMI - VGR Positions
- HMI - SSC Positions
- HMI - Calibration
- HMI - Config Data
- ft Cloud
- Lernfabrik 4.0 - Overview
- Lernfabrik 4.0 - Graph

Color sensor calibration

Calibrate color sensor

Sensor selection: Select sensor

Color sensor actual value: 0

Color value white: 0

Color value red: 0

Color value blue: 0

Set calibration value:

Threshold white-red: 0

Threshold red-blue: 0

Calculate threshold:

SLD push out counter

Calibrate push out

pushout val. white: 5

pushout val. red: 16

pushout val. blue: 26

Set calibration value:

HMI – Config Data

After calibrating the colour sensors and positions, the data in the **“Save Data”** window from the PLC can be stored in a *.csv file  in this menu.

The calibration data from a *.csv file can be loaded  to the PLC in the **“Load Data”** window.

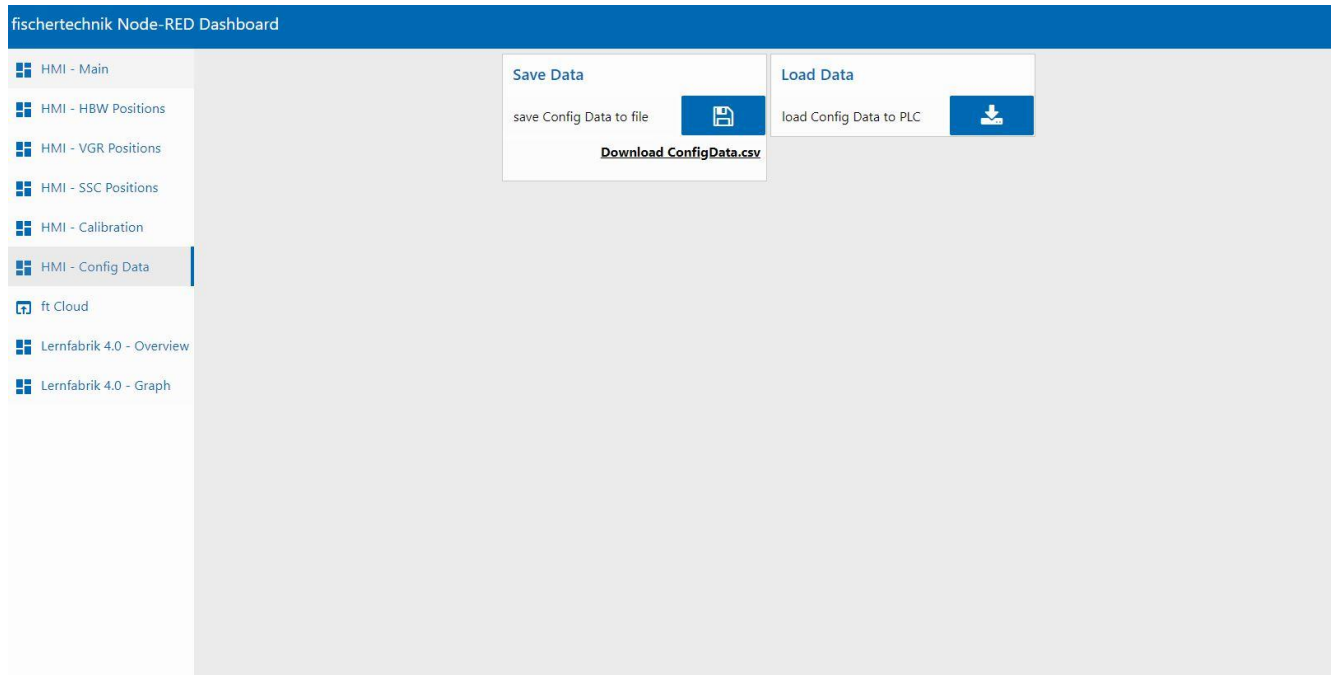

ft Cloud

The fischertechnik cloud can be accessed in this menu. There must be an internet connection to do so.

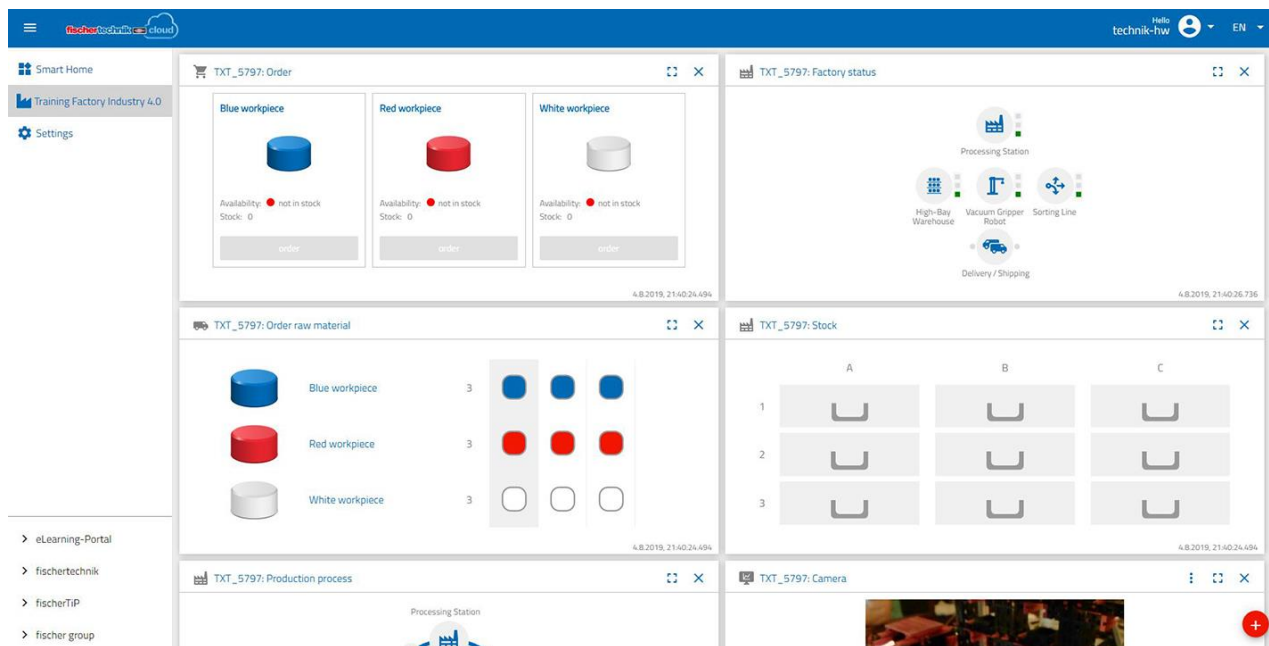

Training Factory Industry 4.04.0 – Overview

The camera image and the sensor data are displayed in this menu.

In addition, a camera controller is available in the **“Camera Control”** window.

An order for a white, red, or blue workpiece can be executed in the **“Order”** window.

Errors can be acknowledged and commands to delete, read and write NFC tags can be executed in the **“Factory Control”** window.

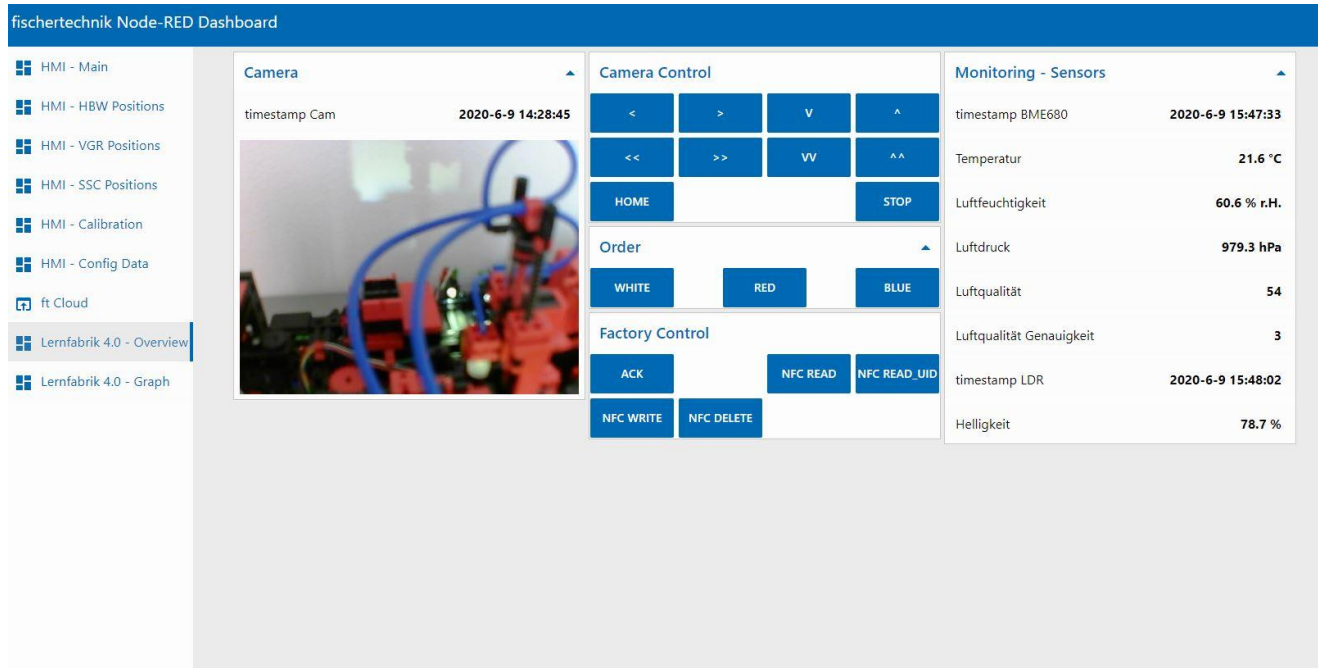

fischertechnik Node-RED Dashboard

- HMI - Main
- HMI - HBW Positions
- HMI - VGR Positions
- HMI - SSC Positions
- HMI - Calibration
- HMI - Config Data
- ft Cloud
- Lernfabrik 4.0 - Overview
- Lernfabrik 4.0 - Graph

Camera

timestamp Cam 2020-6-9 14:28:45

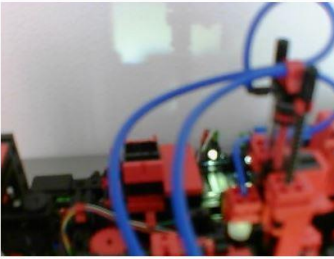

Camera Control

< > V ^

<< >> VV ^^

HOME STOP

Order

WHITE RED BLUE

Factory Control

ACK NFC READ NFC READ_UID

NFC WRITE NFC DELETE

Monitoring - Sensors

timestamp BME680 2020-6-9 15:47:33

Temperatur 21.6 °C

Luftfeuchtigkeit 60.6 % r.H.

Luftdruck 979.3 hPa

Luftqualität 54

Luftqualität Genauigkeit 3

timestamp LDR 2020-6-9 15:48:02

Helligkeit 78.7 %

Training Factory Industry 4.04.0 – Graph

Graphs for environmental data can be accessed in different windows in this menu.

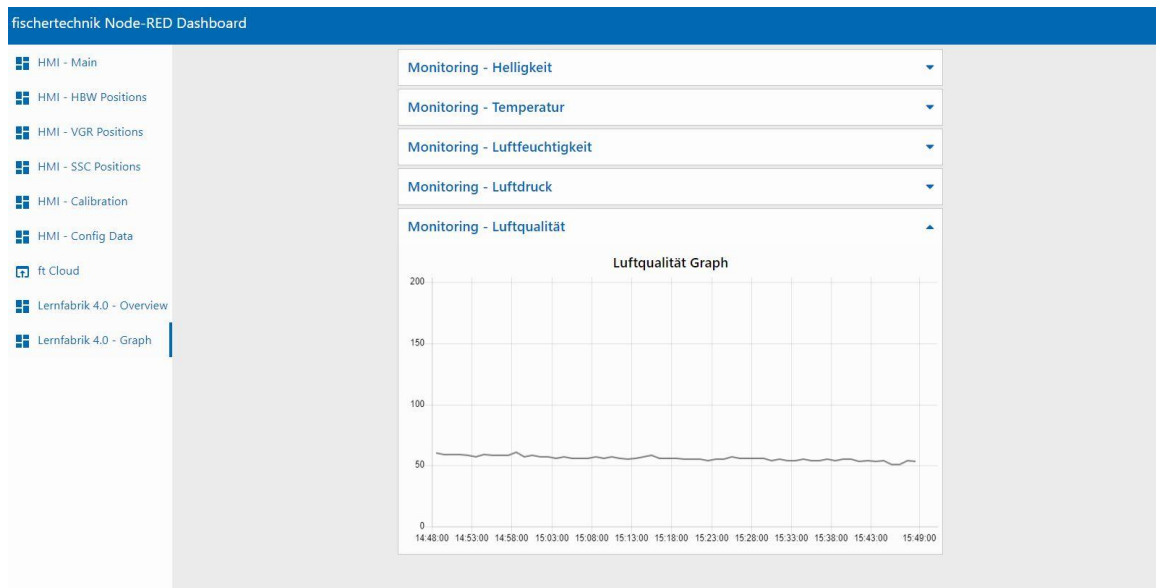

fischertechnik Node-RED Dashboard

- HMI - Main
- HMI - HBW Positions
- HMI - VGR Positions
- HMI - SSC Positions
- HMI - Calibration
- HMI - Config Data
- ft Cloud
- Lernfabrik 4.0 - Overview
- Lernfabrik 4.0 - Graph

Monitoring - Helligkeit

Monitoring - Temperatur

Monitoring - Luftfeuchtigkeit

Monitoring - Luftdruck

Monitoring - Luftqualität

Luftqualität Graph



Calibrating the system in the Training Factory Industry 4.0 fischertechnik Node-RED Dashboard

If positions in the individual factory modules are no longer correct, or if the colour sensors need to be recalibrated, this can be completed in the fischertechnik Node-RED dashboard of the Learning Factory.

Calibrating the colour sensors:

The colour sensors are calibrated in the **“Colour sensor calibration”** window in the dashboard under **“HMI - Calibration”**.

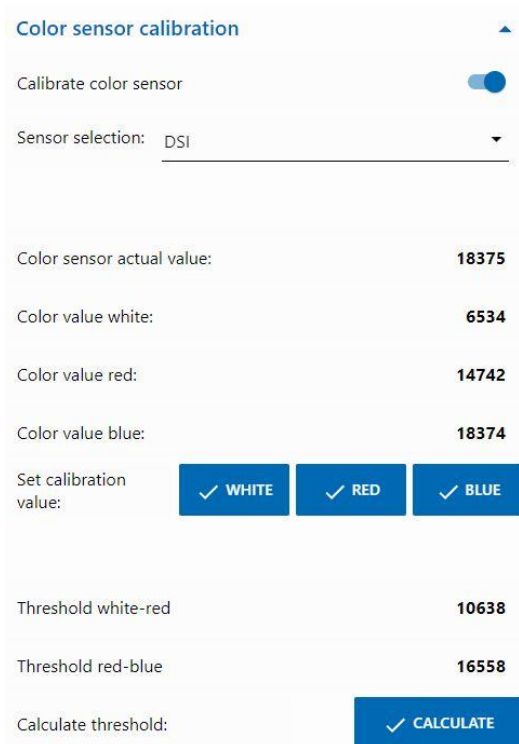

| Field | Value |
|----------------------------|-------|
| Color sensor actual value: | 18375 |
| Color value white: | 6534 |
| Color value red: | 14742 |
| Color value blue: | 18374 |
| Threshold white-red | 10638 |
| Threshold red-blue | 16558 |

The process is started by activating **“Calibrate colour sensor”** and selecting the relevant colour sensor. Here, for example, this is **“DSI”**.

- DSI stands for the colour sensor on the input / output station

- SLD stands for the colour sensor on the sorting station

First, place the white workpiece in the centre of the sensor and confirm the value by clicking **✓ WHITE**, then place the red workpiece and confirm by clicking **✓ RED** and finally place the blue workpiece and confirm by clicking **✓ BLUE**.

Finally, click **✓ CALCULATE** to calculate threshold values.

Note: At the end, do not forget to deactivate **“Calibrate colour sensor”**.

Calibration of colour sensors in the sorting station (SLD) is completed in the same way, although in this case each workpiece is placed on the start of the belt for measurement. The conveyor belt then transports the workpiece past the colour sensor to the light barrier behind the colour sensor.

Calibrating positions on the sorting line with colour detection (SLD):

The positions to push out the workpieces in the sorting line with colour detection (SLD) are calibrated in the "SLD push out counter" window in the dashboard under "HMI - calibration".

SLD push out counter ▲

Calibrate push out

pushout val. white: ▼ 5 ▲

pushout val. red: ▼ 16 ▲

pushout val. blue: ▼ 26 ▲

Set calibration value:

The process is started by activating "Calibrate push out" .

Then, first test whether the current positions are correct for all 3 colours (white/red/blue).

Do so by placing the workpieces on the start of the conveyor belt. The conveyor belt will then transport the workpiece past the colour sensor to the set positions on the relevant ejection point. The part is ejected there.

If the position is not correct, it can be corrected and adopted by clicking . Then the test should be completed again. Repeat this process as long as necessary for all 3 colours (white/red/blue) until the positions are correct.

Note: At the end, do not forget to deactivate "Calibrate push out" .

Calibrating a position on the sensor station with camera (SSC):

The camera positions in the sensor station with camera (SSC) are calibrated in the windows **“move to position”**, **“Position Centre”** and **“Position HBW”** in the dashboard under **“HMI - SSC Positions”**.

move to position

Activate pos. move

SSC Positions: HBW ▼

Pos. value horizontal: 0

Pos. value vertical: 0

Start positioning: ✓ START

Home positioning: ✓ HOME

The process is started by activating **“Activate pos. move”** .

Then, one of the two positions **“Centre”** (central position looking toward the vacuum suction gripper) or **“HBW”** as shown here (position with view of the high-bay warehouse) can be selected.

Clicking ✓ START will cause the camera to move first to the reference position (0/0) and then to the position **“HBW”**.

Test both positions.

If one of the positions is not correct, it can be corrected in the **“Position Centre”** or **“Position HBW”** windows. Then the test should be completed again.

Repeat this process until all positions are correct.

| Position Centre ▲ | Position HBW ▲ |
|---|---|
| horizontal: ▼ 3000 ▲ | horizontal: ▼ 5400 ▲ |
| vertical: ▼ 1400 ▲ | vertical: ▼ 950 ▲ |

Click ✓ HOME to move to the reference position (0/0).

Note: At the end, do not forget to deactivate **“Activate pos. move”** .

Calibrating a position for the vacuum suction gripper (VGR):

The positions of the 3-axis robot in the vacuum suction gripper station (VGR) are calibrated in the dashboard under "HMI - VGR Positions". Here, there are the window "move to position" and 13 windows for the positions

"Position Colour Reader", "Position DSI collect", "Position DSI discard", "Position DSO collect", "Position DSO discard", "Position HBW collect", "Position HBW discard", "Position MPO", "Position NFC", "Position NOK", "Position SLD white", "Position SLD red" and "Position SLD blue".

| | |
|-----------------------|---|
| Position Color Reader | ▼ |
| Position DSI | ▼ |
| Position DSO | ▼ |
| Position HBW | ▼ |
| Position MPO | ▼ |
| Position NFC | ▼ |
| Position NiO | ▼ |
| Position SLD | ▼ |

move to Position

Activate pos. move

VGR Positions: DSO discard ▼

Pos. value horizontal: **2070**

Pos. value vertical: **1480**

Pos. value rotation: **950**

Start positioning:

Final positioning:

Start offset:

Home positioning:

The process is started by activating "Activate pos. move" .

Then one of the positions, for example position "DSO discard" can be selected.

Click to cause the 3-axis robot to move first to the reference position (0/0/0) and then to a position above (offset by the value Offset) the position "DSO discard".

Click and it will move to the final position, then back to the reference position (0/0/0).

The button is non-functional here.

Test all 13 positions in this way.

| Position DSO | |
|-------------------|----------|
| horizontal: | ▼ 2070 ▲ |
| vertical Collect: | ▼ 1480 ▲ |
| vertical Discard: | ▼ 1480 ▲ |
| rotate: | ▼ 950 ▲ |
| vertical Offset: | ▼ 200 ▲ |

If one of the positions is not correct, it can be corrected in the position windows, here for example **“Position DSO”**. Then the test should be completed again.

Repeat this process until all positions are correct.

Click  to move to the reference position (0/0/0).

Note: At the end, do not forget to deactivate **“Activate pos. move”** .

Calibrating a position for the automated high-bay warehouse (HBW):

The positions of the stacker crane in the automated high-bay warehouse station (HBW) are calibrated in the dashboard under **“HMI - HBW Positions”**. Here, there are the window **“move to position”** and 5 windows for the positions

“Position Belt”,

“Position Rack”

with the offset for the rack,

“Position Rack Row A”,

“Position Rack Row B”,

and

“Position Rack Row C”,

| | |
|---------------------|---|
| Position Belt | ▼ |
| Position Rack | ▼ |
| Position Rack Row A | ▼ |
| Position Rack Row B | ▼ |
| Position Rack Row C | ▼ |

Only the positions Rack A1, Rack B2 and Rack C3 are approached and calibrated in the warehouse. The other 6 position values are calculated on this basis.

move to Position

Activate pos. move

HBW Positions: Rack B2

Pos. value horizontal: 5240

Pos. value vertical: 1750

Start positioning: ✓ START

Final positioning: ✓ FINAL

Start offset: ✓ OFFSET

Home positioning: ✓ HOME

The process is started by activating "Activate pos. move" .

Then one of the positions, for example position "Rack B2" (position B2 in the warehouse) can be selected.

Clicking ✓ START will cause the stacker crane to move first to the reference position (0/0/Cantilever rear) and then to the position "Rack B2" before the warehouse.

Click ✓ FINAL to move the cantilever into the warehouse.

Click ✓ OFFSET to move the stacker crane up by the value offset to lift a pallet.

Click ✓ OFFSET once again to move the stacker crane back down by the value offset, then move the cantilever in and finally back to the reference position (0/0/Cantilever rear)

Test all 3 positions in the warehouse (A1, B2, C3) and the positions on the belt.

Position Rack ▲

vertical Offset: ▼ 370 ▲

Position Rack Row B ▲

B2 horizontal: ▼ 5240 ▲

B2 vertical: ▼ 1750 ▲

If one of the positions is not correct, this can be corrected in the position windows, here for example "Position Rack Row B" (Position Rack B2). Then the test should be completed again.

Repeat this process until all positions are correct.

Click ✓ HOME to move to the reference position (0/0/Cantilever rear).

Note: At the end, do not forget to deactivate "Activate pos. move" .

Components description

The most important components of the factory modules are described on the following pages.

Actuators

Both encoder motors and fischertechnik-specific mini motors are installed in the individual stations.

Encoder motor:

The encoder motors are permanently energised DC motors. The encoder motors used here can be used to determine paths with a quadrature encoder (signal A, B).

The encoder motors operate at a nominal voltage of 24 VDC and have a maximum power of 0.9 W and at a maximum speed of 200 RPMs. Power consumption at maximum power is 180 mA.

The encoders generate 3 pulses per rotation of the motor shaft. The integrated transmission has a ratio of 20.4:1. Therefore, one rotation of the shaft coming out of the transmission corresponds to 61.2 pulses of the encoder.

A four-wire cable is used to connect the encoder.

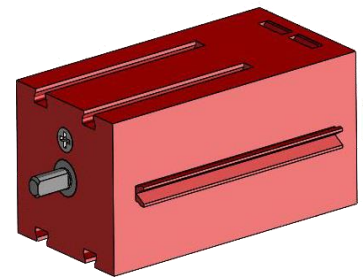

Mini motor

If conveyor belts or processing machines are used in the individual stations, they are driven by a mini-motor. This compact motor is a permanently energised DC motor that can be used in conjunction with a plug-in U transmission

. The motor's rated voltage is 24 V and the current consumption is a maximum of 400 mA. The motor has a maximum torque of 6.92 mNm and an idling speed of 10,910 RPMs. The U-transmission has a ratio of 64.8: 1 and a lateral output.

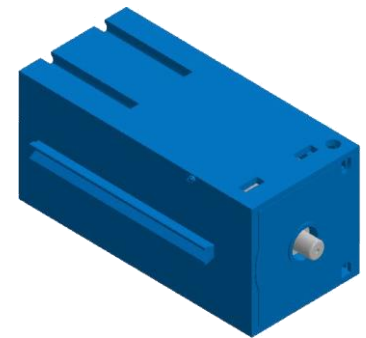
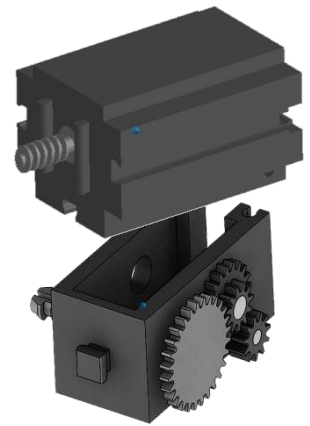

Compressor:

A diaphragm pump is used if a compressed air source is required at the stations.

Such a diaphragm pump consists of two chambers, which are separated by a membrane (see Figure 1). In one of these two chambers, a piston is moved back and forth by an eccentric, which reduces or increases the volume in the other chamber. When the piston moves to the right, the diaphragm is pulled back, sucking air into the second chamber via the inlet valve. If the piston moves to the left, the diaphragm pushes the air out of the pump head via the outlet valve. The compressor here uses a rated voltage of 24 VDC and generates an overpressure of 0.7 bar. The compressor's maximum current consumption is 36 mA.

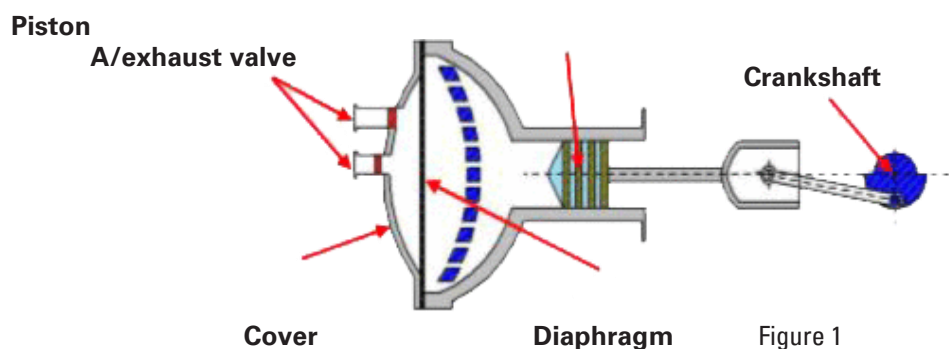

3/2-way solenoid valve:

3/2-way solenoid valves are used to control the pneumatic cylinders. These switching valves have three connections and two switching states. A coil (a) that works against a spring (c) carries out the switching operations. When a voltage is applied to the coil, the coil's mounted core (b), which is mounted so that it can slide, moves against the spring and thereby opens the valve due to the Lorentz force.

In this case, opening means that the compressed air connection (current designation: 1, old name: P) is connected to the cylinder port (2, formerly A). If this voltage drops, the spring pushes the core back and closes the valve again. In this position, the cylinder port (2, formerly A) is connected to the vent (3, formerly R). The figure shows a schematic representation of the 3/2-way solenoid valve.

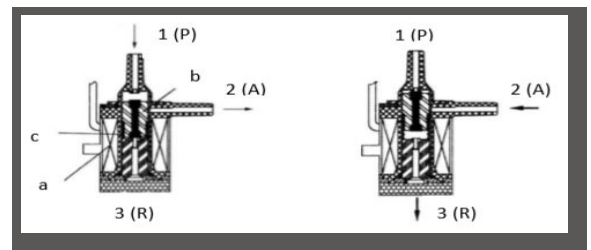
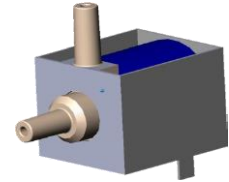

Pneumatic cylinders:

The factory has a total of 5 single-acting cylinders with spring installed. These are controlled by the 3/2-way solenoid valves. A piston divides the volume of the cylinder into two chambers on pneumatic cylinders. A pressure difference between these two chambers results in a force that acts on the piston, thereby displacing it. This shift corresponds to a volume change in both chambers. Installing a return spring saves on a second air connection with 3/2-way valve. When the 3/2-way solenoid valve is opened, the air produced in the compressor flows to port 1 on the cylinder and pushes the piston forward against the spring force. To do this, the piston rod extends forwards. When the solenoid valve closes the air supply, the spring pushes the piston back to the initial position.

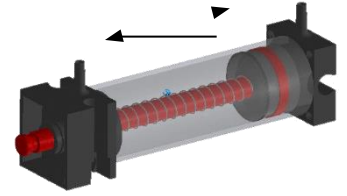

Vacuum cups:

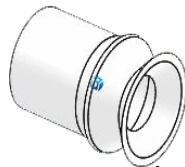

The suction function on the vacuum suction device is achieved by using two pneumatic cylinders which are controlled by means of a 3/2-way solenoid valve. In order to generate a negative pressure, i.e., a pressure which is lower than the ambient pressure, two cylinders are mechanically coupled in the vacuum gripper. If a cylinder is then subjected to overpressure, both piston rods extend, resulting in an increase in volume in the chamber that the vacuum closes. This increase in volume causes a pressure drop in this chamber.

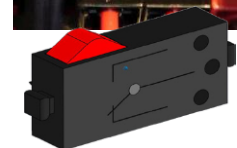
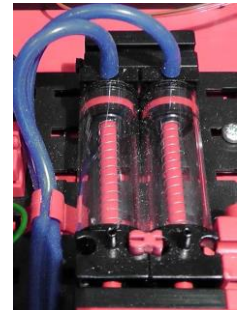

Mini-button:

Mini-pushbuttons are used as reference switches. They are used for position determination using a point-to-point movement, for example, at the turntable. The miniature pushbutton used here is equipped with a changeover contact and can be used both as a normally closed contact and as a make contact.

Pressing the button creates a conductive connection between contact 1 and contact 3, whereas the connection between contact 1 and contact 2 is disconnected. The figure shows the schematic circuit diagram of the mini-pushbutton.

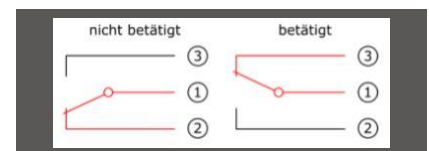

LED

An LED is an electronic component which converts electrical energy into light. The abbreviation LED stems from the English "Light Emitting Diode".

LED for creating light in a light barrier and as a lamp

This LED's light frequency controls a photo-resistor. The "+" and "L" identify the module. Another feature is the vitreous body. It bundles rays, so that the light beams hit the photo-transistor in parallel to one another, and not scattered.



Sensors

Photo-transistor

Photo-transistors are electronic components that react to light. Photo-transistors usually only have two connections, the collector and the emitter. The base is replaced by the incident light. Light from the LED that hits the photo-transistor switches the current flow. This behaviour can be evaluated using program technology.

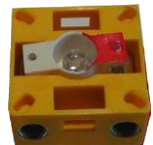

Photo-resistor

A photo-resistor is an electronic component whose electrical resistance changes when light strikes it. In many descriptions you will also find the name LDR. This term comes from the English word, "light-dependent resistor".



Important: The photo-resistor has a resistance value of 0 - >1M Ω (in complete darkness). The TXT Controller software lets you read a maximum value of 15,000

sensors

Environment sensor

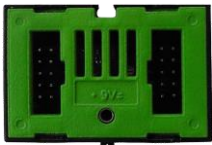

The sensor, which is located on a circuit board in the housing, is used to measure gas, air pressure, humidity and air temperature. The component is

connected to the TXT controller via a ribbon cable.

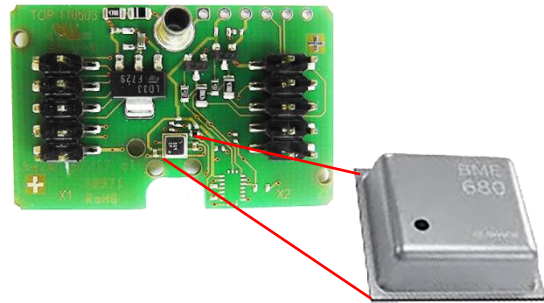

The data is continuously measured and stored in a CSV file that can be opened in Excel, for example. The values can be viewed in the fischertechnik cloud.

These images show a part of the dashboard of the environmental station.

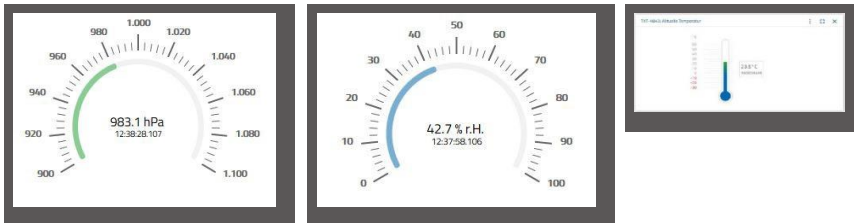

Colour sensor

Colour sensors are used in the automation technology to check the colour or a colour print. For example, this is done to ensure that the correct components were installed. The fischertechnik colour sensor emits white light, which different colour surfaces reflect to different degrees. The photo-transistor is used to measure the intensity of reflected light and a voltage value between 0 V and 9 V is output. The measured value depends on the ambient brightness as well as the distance of the sensor from the coloured surface. The connection is made via three cables. The red cable is attached to a 9V output (generated from 24V), the green cable is connected to ground, and the black cable for the measured value is connected to a 0-10V analogue input on the PLC. This measured value (0-9 V) is digitised into a whole number between 0 and 24883.



NFC-Tags NTAG213 22mm

Each workpiece has its own unique ID and displays the following data: Status, colour and time stamp from delivery to dispatch. This information is saved on the tags. The tags are integrated into the workpiece, which lets them be used directly.

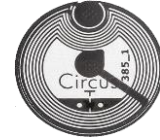

PN532 V3 NFC-reader

This component describes and reads out the NFC-tags. The production view on the NFC/RFID reader displays the workpiece data and can be used to read or delete workpieces manually. The raw data on the

NFC tags can be read out using a standard NFC app from mobile devices with NFC readers. The NFC-reader is connected to an I²C interface and a 3.3 V power supply at the EXT connection on the TXT controller.

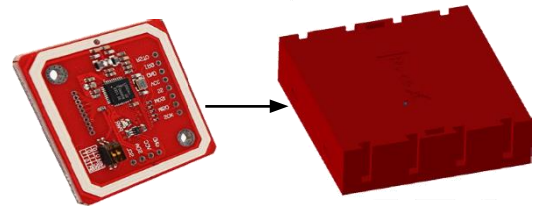

nano Router TP-Link

The connection to the fischertechnik cloud is established via the WiFi router supplied and integrated into the learning factory. We recommend using the web browsers such as Chrome or Firefox. The cloud can be used via a personal access, which is created once (www.fischertechnik-cloud.com). The cloud servers



are located in Germany and ensure that strict European requirements apply to data storage.

Personal data is protected in an account with password access that uses extremely secure "OAuth2" industry standard. All data sent to the cloud is transmitted encrypted with certificates (https standard, green lock in web browser).

Camera



The surveillance camera mounted on the multi-processing station (MPO) is connected to the TXT controller via a USB interface. It can be controlled using the dashboard in the fischertechnik cloud.

TXT controller

The complete performance data for the TXT controller can be viewed at www.fischertechnik.de/simulieren, here are the most important features:



- Dual Processor: ARM Cortex A8 (32-bit/600MHz) + Cortex M3
- Storage capacity: 256 MB DDR3 RAM, 128 MB Flash
- Storage extension: Micro SD card slot
- Display: colour 2.4-inch touch display (320x240 pixels) 8 universal inputs: Digital/Analogue 0-9VDC, Analogue 0-5 k Ω
- Display: colour 2.4" touch display (320x240 pixels)
- 4 quick counter inputs: Digital, frequency up to 1 kHz
- 4 motor outputs 9 V/250 mA (max.: 800 mA): Infinitely variable speed, short-circuit-proof, alternatively 8 individual outputs, e.g. for lamps
- Combined Bluetooth/WiFi wireless module: BT 2.1 EDR+ 4.0, WiFi 802.11 b/g/n
- Infrared receiver diode
- USB 2.0 client: Mini USB port for connection with the PC
- USB Host port: USB-A port for fischertechnik USB camera, USB sticks, etc.
- Camera interface: via USB host, Linux camera drivers integrated in the operating system
- 10-pole pin row to increase inputs and outputs as well as I2C-port
- Integrated loudspeaker
- Integrated real-time clock with replaceable buffer battery for recording the measured values in a defined period
- Linux based Open-Source operating system
- Programming possible with ROBO Pro, C-Compiler, PC-Library, etc.
- Power supply: 9V DC 3.45 mm port, or fischertechnik 2.5 mm ports

24V adapter board

There is an adapter board on every Factory module for connecting to the PLC; it is structured as follows:

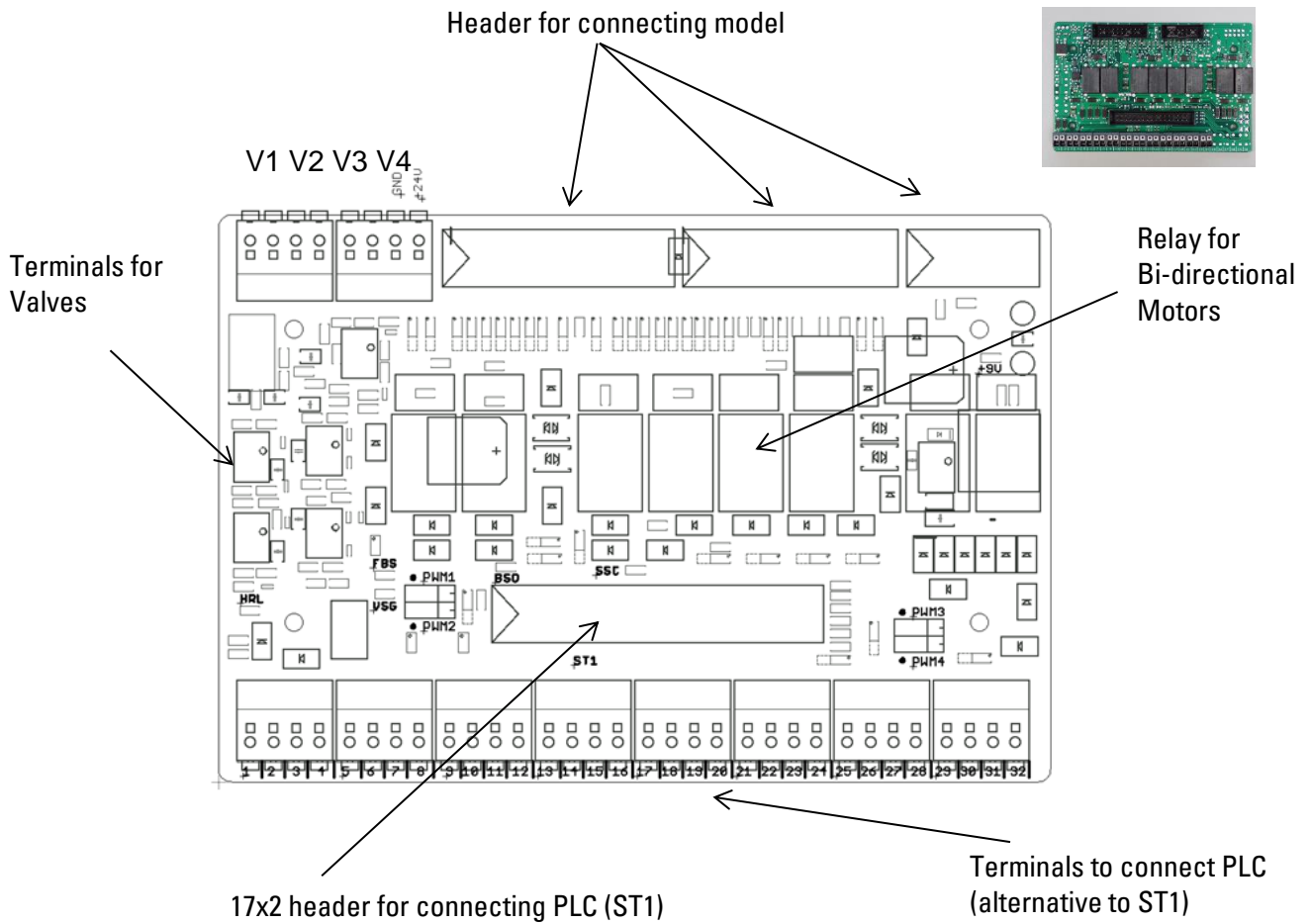

PLC / controller system requirements:

If a different controller besides a PLC SIMATIC S7-1500 is used, such as an Arduino, the following requirements must be fulfilled.

- Interface to the adapter board compatible with 24V
- Maximum cycle time of 10 ms

Assigning the 17x2 header (ST1) for PLC connection:

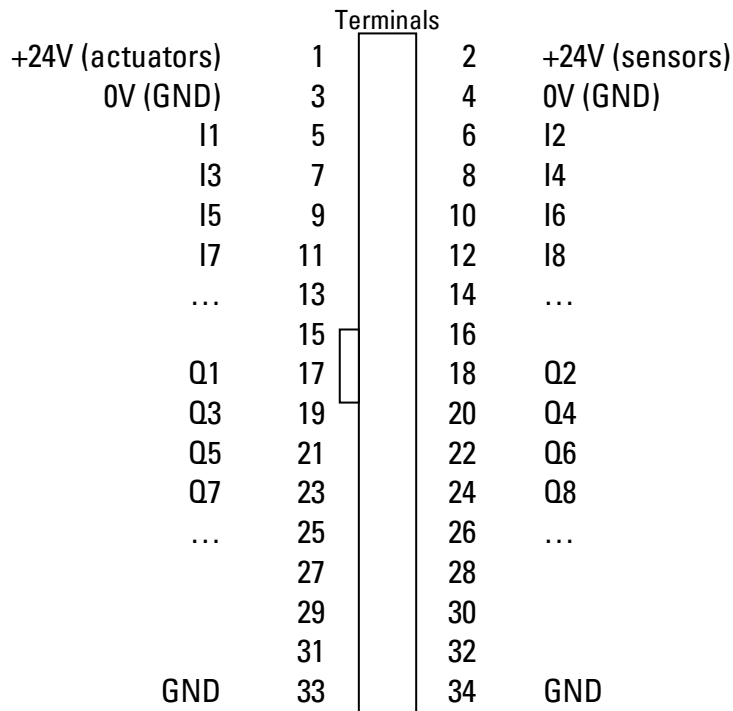

Assigning the adapter boards to the individual stations:

| | High-bay warehouse (HBW) | Vacuum suction Gripper (VGR) | Processing Station (MPO) | Sorting line (SLD) | Sensor station with camera (SSC) |
|------------|--------------------------|------------------------------|--------------------------|--------------------|----------------------------------|
| R1/R2 | Conveyor belt | Vertical | Turntable | - | |
| R3/R4 | Horizontal | Horizontal | - | - | Camera height |
| R5/R6 | Vertical | Turntable | Oven pusher | - | Turn camera |
| R7/R8 | Cantilever | - | Gripper | - | |
| V1 | - | - | Vacuum | White ejector | |
| V2 | - | - | Lower | Red ejector | |
| V3 | - | - | Oven door | Blue ejector | |
| V4 | - | Vacuum | Slides | - | |
| ST (Model) | 20 pin | 16 pin | 20 pin | 20 pin | 10 pin |
| ST (Model) | 14 pin | 10 pin | 20 pin | 14 pin | 14 pin |
| ST (Model) | | | | | 10 pin |
| ST1 (PLC) | 34 pin | 34 pin | 34 pin | 34 pin | 34 pin |

Pulse width modulation:

Bi-directional motors are converted via a relay and can be supplied either via 24V (actuators) or the associated PWM terminal.

The jumpers are on the adapter board

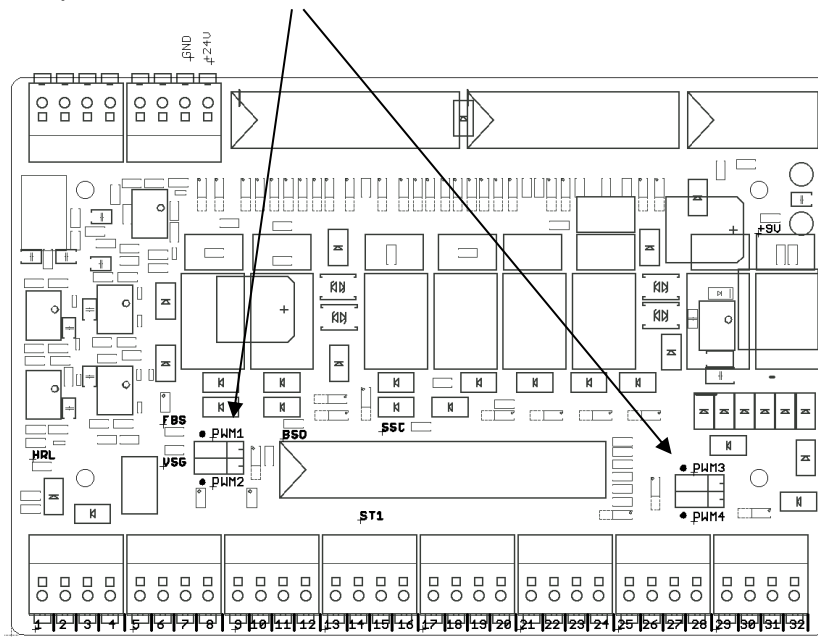

| | High-bay warehouse (HBW) | Vacuum suction gripper (VGR) | Processing station (MPO) | Sorting line (SLD) | Sensor station with camera (SSC) |
|-------|--------------------------|------------------------------|--------------------------|--------------------|----------------------------------|
| PWM 1 | Conveyor belt | Y(Vertical) | Turntable | - not assigned - | - not assigned - |
| PWM 2 | X(Horizontal) | Z(Horizontal) | - not assigned - | - not assigned - | Camera height |
| PWM 3 | Y(Vertical) | X(Turn) | - not assigned - | - not assigned - | Turn camera |
| PWM 4 | Cantilever | | Suction (Horizontal) | - not assigned - | - not assigned - |

Assigning the PWM jumper:

Jumper left: PWM selected, motor converted via relay and
Supplied with power via the associated PWM terminal

Jumper right: Power supply via +24V (actuators), motor can be converted via a relay

Factory module assignment plans

Assignment plan for the vacuum suction gripper

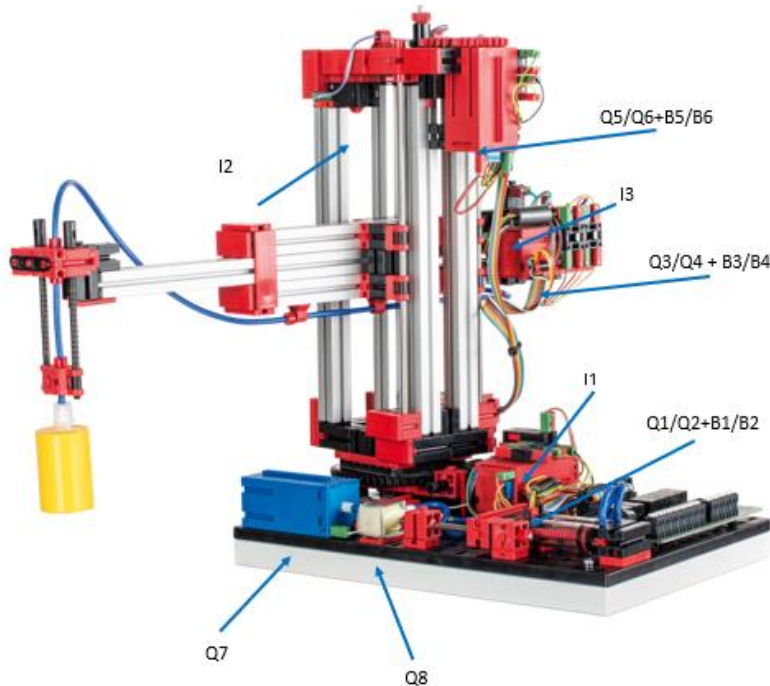

| Terminal no. (ST1) | Function | Designation | Clamp PLC | I/O address S7-1500 | Variable name S7-1500 |
|--------------------|-----------------------------|-------------|-----------|---------------------|-------------------------------------|
| 1 | Power supply (+) actuators | 24V DC | | | |
| 2 | Power supply (+) sensors | 24V DC | | | |
| 3 | Power supply (-) | 0V | | | |
| 4 | Power supply (-) | 0V | | | |
| 5 | Vertical reference switch | I1 | DI1.6 | %I1.6 | IX_VGR_RefSwitchVerticalAxis_I1 |
| 6 | Horizontal reference switch | I2 | DI3.6 | %I3.6 | IX_VGR_RefSwitchHorizontalAxis_I2 |
| 7 | Turn reference switch | I3 | DI3.7 | %I3.7 | IX_VGR_RefSwitchRotate_I3 |
| 9 | Encoder vertical pulse 1 | B1 | DI6.0 | %I6.0 | IX_VGR_EncoderVerticalAxisImp1_B1 |
| 10 | Encoder vertical pulse 2 | B2 | DI6.4 | %I6.4 | IX_VGR_EncoderVerticalAxisImp2_B2 |
| 11 | Encoder horizontal pulse 1 | B3 | DI6.1 | %I6.1 | IX_VGR_EncoderHorizontalAxisImp1_B3 |
| 12 | Encoder horizontal pulse 2 | B4 | DI6.5 | %I6.5 | IX_VGR_EncoderHorizontalAxisImp2_B4 |
| 13 | Turn encoder pulse 1 | B5 | DI6.2 | %I6.2 | IX_VGR_EncoderRotateImp1_B5 |
| 14 | Turn encoder pulse 2 | B6 | DI6.6 | %I6.6 | IX_VGR_EncoderRotateImp2_B6 |
| 17 | Vertical motor up | Q1 (M1) | D02.0 | %Q2.0 | QX_VGR_M1_VericalAxisUp_Q1 |
| 18 | Vertical motor down | Q2 (M1) | D02.1 | %Q2.1 | QX_VGR_M1_VericalAxisDown_Q2 |
| 19 | Horizontal motor backwards | Q3 (M2) | D02.2 | %Q2.2 | QX_VGR_M2_HorizontalAxisBackward_Q3 |
| 20 | Horizontal motor forwards | Q4 (M2) | D02.3 | %Q2.3 | QX_VGR_M2_HorizontalAxisForward_Q4 |
| 21 | Turn motor clockwise | Q5 (M3) | D02.4 | %Q2.4 | QX_VGR_M3_RotateClockwise_Q5 |
| 22 | Turn motor anti-clockwise | Q6(M3) | D02.5 | %Q2.5 | QX_VGR_M3_RotateCounterclockwise_Q6 |
| 23 | Compressor | Q7 | D02.6 | %Q2.6 | QX_VGR_Compressor_Q7 |
| 24 | Valve vacuum | Q8 | D02.7 | %Q2.7 | QX_VGR_ValveVacuum_Q8 |
| 25 | PWM horizontal | PWM (M1) | D08.0 | %QW15 | QW_VGR_PWM_Verical_M1 |
| 26 | PWM vertical | PWM (M2) | D08.1 | %QW17 | QW_VGR_PWM_Horizontal_M2 |
| 27 | Turn PWM | PWM (M3) | D08.2 | %QW19 | QW_VGR_PWM_Rotate_M3 |

Model wiring

| Terminal | Header ST1 | Ribbon cable | Sensors + actuators model |
|----------|----------------------|--------------|--|
| 17 | Vertical up | 1 | Q1/Q2 (M1) |
| 18 | Vertical down | 2 | |
| 3.4 | GND | 3 | Encoder power supply A Signal A Signal B |
| 2 | 24V (Sensor) | 4 | |
| 9 | A | 5 | |
| 10 | B | 6 | |
| 5 | Reference vertical | 7 | I1 |
| 2 | 24V | 8 | |
| 19 | Horizontal back | 9 | Q3/Q4 (M2) |
| 20 | Horizontal forward | 10 | |
| 3.4 | GND | 11 | Encoder power supply A Signal A Signal B |
| 2 | 24V (Sensor) | 12 | |
| 11 | A | 13 | |
| 12 | B | 14 | |
| 6 | Reference horizontal | 15 | I2 |
| 2 | 24V (Sensor) | 16 | |

| Terminal | Header ST2 | Ribbon cable | Sensors + actuators model |
|----------|---------------------|--------------|--|
| 7 | Turn reference | 1 | I3 |
| 2 | 24V (Sensor) | 2 | |
| 21 | Turn clockwise | 3 | Q5/Q6 (M3) |
| 22 | Turn anti-clockwise | 4 | |
| 3.4 | GND | 5 | Encoder power supply A Signal A Signal B |
| 2 | 24V (Sensor) | 6 | |
| 13 | A | 7 | |
| 14 | B | 8 | |
| 3.4 | GND | 9 | Q7 (compressor) |
| 23 | Compressor | 10 | |

| | |
|-----|-------------|
| 3.4 | Terminal V4 |
| 24 | |

| |
|-------------------|
| Q8 (Valve vacuum) |
|-------------------|





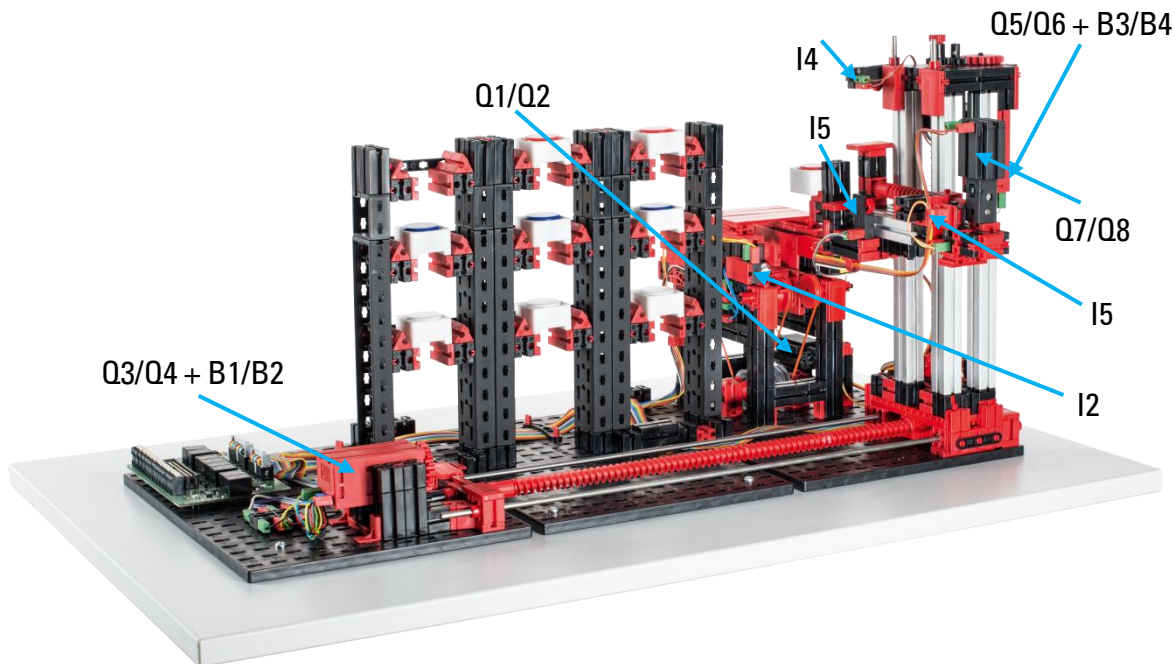



















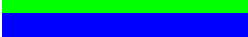

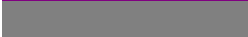



red = power supply
yellow = Motor poles reversible via relay

Assignment plan for automated high-bay warehouse (HBW)



| Terminal no. (ST1) | Function | Designation | Clamp SPS | I/O address S7-1500 | Variable name S7-1500 |
|--------------------|--|-------------|-----------|---------------------|--|
| 1 | Power supply (+) actuators | 24V DC | | | |
| 2 | Power supply (+) sensors | 24V DC | | | |
| 3 | Power supply (-) | 0V | | | |
| 4 | Power supply (-) | 0V | | | |
| 5 | Reference pushbutton horizontal | I1 | DI1.0 | %I1.0 | IX_HBW_RefSwitchHorizontalAxis_I1 |
| 6 | Light barrier inside | I2 | DI1.1 | %I1.1 | IX_HBW_LightBarrierInside_I2 |
| 7 | Light barrier outside | I3 | DI1.2 | %I1.2 | IX_HBW_LightBarrierOutside_I3 |
| 8 | Reference pushbutton vertical | I4 | DI1.3 | %I1.3 | IX_HBW_RefSwitchVerticalAxis_I4 |
| 11 | Encoder horizontal pulse 1 | B1 | DI5.1 | %I5.1 | IX_HBW_EncoderHorizontalAxisImp1_B1 |
| 12 | Encoder horizontal pulse 2 | B2 | DI5.5 | %I5.5 | IX_HBW_EncoderHorizontalAxisImp2_B2 |
| 13 | Encoder vertical pulse 1 | B3 | DI5.2 | %I5.2 | IX_HBW_EncoderVerticalAxisImp1_B3 |
| 14 | Encoder vertical pulse 2 | B4 | DI5.6 | %I5.6 | IX_HBW_EncoderVerticalAxisImp2_B4 |
| 15 | Reference pushbutton probe arm front | I5 | DI1.4 | %I1.4 | IX_HBW_SwitchCantileverFront_I5 |
| 16 | Reference pushbutton probe arm rear | I6 | DI1.5 | %I1.5 | IX_HBW_SwitchCantileverBack_I6 |
| 17 | Conveyor belt motor forwards | Q1 (M1) | DO1.0 | %Q1.0 | QX_HBW_M1_ConveyorBeltForward_Q1 |
| 18 | Conveyor belt motor backwards | Q2 (M1) | DO1.1 | %Q1.1 | QX_HBW_M1_ConveyorBeltBackward_Q2 |
| 19 | Motor horizontal towards rack | Q3 (M2) | DO1.2 | %Q1.2 | QX_HBW_M2_HorizontalTowardsRack_Q3 |
| 20 | Motor horizontal towards conveyor belt | Q4 (M2) | DO1.3 | %Q1.3 | QX_HBW_M2_HorizontalTowardsConveyorBelt_Q4 |
| 21 | Vertical motor down | Q5 (M3) | DO1.4 | %Q1.4 | QX_HBW_M3_VerticalAxisDownward_Q5 |
| 22 | Vertical motor up | Q6 (M3) | DO1.5 | %Q1.5 | QX_HBW_M3_VerticalAxisUpward_Q6 |
| 23 | Cantilever motor forwards | Q7 (M4) | DO1.6 | %Q1.6 | QX_HBW_M4_CantileverForward_Q7 |
| 24 | Cantilever motor backwards | Q8 (M4) | DO1.7 | %Q1.7 | QX_HBW_M4_CantileverBackward_Q8 |
| 25 | PWM conveyor belt | PWM (M1) | DO7.0 | %QW7 | QW_HBW_PWM_ConveyorBelt_M1 |
| 26 | PWM horizontal | PWM (M2) | DO7.1 | %QW9 | QW_HBW_PWM_HorizontalAxis_M2 |
| 27 | PWM vertical | PWM (M3) | DO7.2 | %QW11 | QW_HBW_PWM_VerticalAxis_M3 |
| 28 | PWM cantilever | PWM (M4) | DO7.3 | %QW13 | QW_HBW_PWM_Cantilever_M4 |

Model wiring

| Terminal | Header ST1 | | Ribbon cable | Sensors + actuators model |
|----------|--|----|---|---|
| 5 | Reference horizontal | 1 |  | I1 |
| 2 | 24V (Sensor) | 2 |  | |
| 6 | Photo-transistor internal | 3 |  | I2 |
| 2 | 24V (Sensor) | 4 |  | |
| 7 | Photo-transistor external | 5 |  | I3 |
| 2 | 24V (Sensor) | 6 |  | |
| 17 | Conveyor belt forwards | 7 |  | Q1/Q2 (M1) |
| 18 | Conveyor belt backwards | 8 |  | |
| 3.4 | GND | 9 | | reserved |
| 2 | 9V (generated from 24V sensor) | 10 |  | |
| 9 | reserved | 11 |  | |
| 10 | reserved | 12 |  | Lights for light barrier |
| 3.4 | GND | 13 |  | |
| 2 | 24V (Sensor) | 14 |  | Q3/Q4 (M2) |
| 19 | Motor horizontal towards rack | 15 |  | |
| 20 | Motor horizontal towards conveyor belt | 16 |  | |
| 3.4 | GND | 17 |  | Horizontal power Signal Signal B |
| 2 | 24V (Sensor) | 18 |  | |
| 11 | A | 19 | | encoder supply A |
| 12 | B | 20 |  | |
| | Header ST2 | | | |
| 8 | Reference pushbutton vertical | 1 |  | I4 |
| 2 | 24V (Sensor) | 2 |  | |
| 21 | Vertical axis down | 3 |  | Q6/Q7 (M3) |
| 22 | Vertical axis up | 4 |  | |
| 3.4 | GND | 5 |  | Vertical power Signal Signal B |
| 2 | 24V (Sensor) | 6 |  | |
| 13 | A | 7 |  | encoder supply A |
| 14 | B | 8 |  | |
| 15 | Reference pushbutton probe arm forward | 9 | | I5 |
| 2 | 24V (Sensor) | 10 |  | |
| 23 | Probe arm forward | 11 |  | Q7/Q8 (M4) |
| 24 | Probe arm back | 12 |  | |
| 16 | Reference pushbutton probe arm rear | 13 |  | I6 |
| 2 | 24V (Sensor) | 14 |  | |

red = power supply
yellow = Motor poles reversible via relay



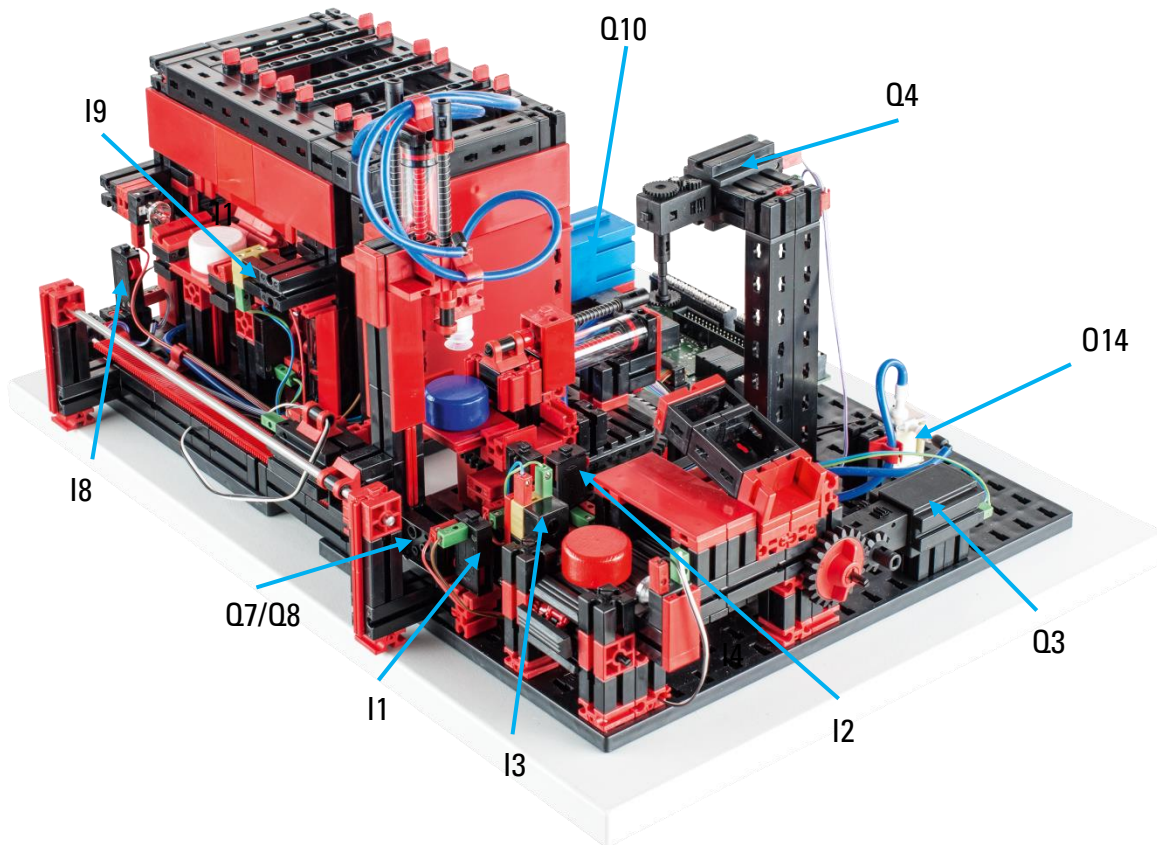











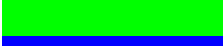



Assignment plan for the multi-processing station with kiln (MPO)











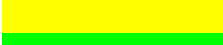
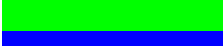

Not shown: Q1, Q2, Q5, Q6, Q9, Q11, Q12, Q13, I4, I5, I6, I7

| Terminal no. (ST1) | Function | Designation | Clamp SPS | I/O address S7-1500 | Variable name S7-1500 |
|--------------------|---|-------------|-----------|---------------------|--|
| 1 | Power supply (+) actuators | 24V DC | | | |
| 2 | Power supply (+) sensors | 24V DC | | | |
| 3 | Power supply (-) | 0V | | | |
| 4 | Power supply (-) | 0V | | | |
| 5 | Reference switch turntable (suction position) | I1 | D11.7 | %I1.7 | IX_MPO_RefSwitchTurnTable_PosVac_I1 |
| 6 | Reference switch turntable (conveyor belt position) | I2 | D12.0 | %I2.0 | IX_MPO_RefSwitchTurnTable_PosBelt_I2 |
| 7 | Light barrier end of conveyor belt | I3 | D12.1 | %I2.1 | IX_MPO_LightBarrierEndOfConBelt_I3 |
| 8 | Reference switch turntable (saw position) | I4 | D12.2 | %I2.2 | IX_MPO_RefSwitchTurnTable_PosSaw_I4 |
| 9 | Reference switch suction (turntable position) | I5 | D12.3 | %I2.3 | IX_MPO_RefSwitchVac_PosTurnTable_I5 |
| 10 | Reference switch oven feeder inside | I6 | D12.4 | %I2.4 | IX_MPO_RefSwitchOvenFeederInside_I6 |
| 11 | Reference switch oven feeder outside | I7 | D12.5 | %I2.5 | IX_MPO_RefSwitchOvenFeederOutside_I7 |
| 12 | Reference switch vacuum (kiln position) | I8 | D12.6 | %I2.6 | IX_MPO_RefSwitchVac_PosOven_I8 |
| 13 | Light barrier kiln | I9 | D12.7 | %I2.7 | IX_MPO_LightBarrierOven_I9 |
| 17 | Turn motor turntable clockwise | Q1 (M1) | D03.0 | %Q3.0 | QX_MPO_M1_TurnTableClockwise_Q1 |
| 18 | Turn motor slewing ring anti-clockwise | Q2 (M1) | D03.1 | %Q3.1 | QX_MPO_M1_TurnTableCounterclockwise_Q2 |
| 19 | Conveyor belt motor forwards | Q3 (M2) | D03.2 | %Q3.2 | QX_MPO_M2_ConveyorBeltForward_Q3 |
| 20 | Motor saw | Q4 (M3) | D03.3 | %Q3.3 | QX_MPO_M3_Saw_Q4 |
| 21 | Retract oven feeder motor | Q5 (M4) | D03.4 | %Q3.4 | QX_MPO_M4_OvenFeederRetract_Q5 |
| 22 | Extend oven feeder motor | Q6 (M4) | D03.5 | %Q3.5 | QX_MPO_M4_OvenFeederExtend_Q6 |
| 23 | Vacuum towards oven motor | Q7 (M5) | D03.6 | %Q3.6 | QX_MPO_M5_VacuumTowardsOven_Q7 |
| 24 | Vacuum towards turntable motor | Q8 (M5) | D03.7 | %Q3.7 | QX_MPO_M5_VacuumTowardsTurnTable_Q8 |
| 25 | Lamp kiln | Q9 | D04.0 | %Q4.0 | QX_MPO_LightOven_Q9 |
| 26 | Compressor | Q10 | D04.1 | %Q4.1 | QX_MPO_Compressor_Q10 |
| 27 | Valve vacuum | Q11 | D04.2 | %Q4.2 | QX_MPO_ValveVacuum_Q11 |
| 28 | Valve lowering | Q12 | D04.3 | %Q4.3 | QX_MPO_ValveLowering_Q12 |
| 29 | Valve kiln door | Q13 | D04.4 | %Q4.4 | QX_MPO_ValveOvenDoor_Q13 |
| 30 | Valve feeder | Q14 | D04.5 | %Q4.5 | QX_MPO_ValveFeeder_Q14 |
| 31 | PWM turntable | PWM (M1) | D09.0 | %QW23 | QW_MPO_PWM_TurnTable_M1 |
| 32 | PWM vacuum | PWM (M5) | D09.1 | %QW25 | QW_MPO_PWM_Vacuum_M5 |

Model wiring

| Terminal | Header ST1 | | Ribbon cable | Sensors + actuators on model |
|----------|-------------------------------------|----|---|------------------------------|
| 5 | Turntable reference button | 1 |  | |
| 2 | 24V (Sensor) | 2 |  | I1 |
| 6 | Turntable reference button | 3 |  | I2 |
| 2 | 24V (Sensor) | 4 |  | I3 |
| 7 | Light barrier end of conveyor belt | 5 |  | |
| 2 | 24V (Sensor) | 6 |  | |
| 17 | Turn motor turntable clockwise | 7 |  | Q1/Q2 (M1) |
| 18 | Turn turntable anti-clockwise | 8 |  | |
| 3.4 | GND | 9 | | |
| 2 | 24V (Sensor) | 10 |  | Light barrier lamp |
| 9 | Vacuum reference button | 11 |  | I5 |
| 2 | 24V (Sensor) | 12 |  | |
| 8 | Turntable reference button pos. saw | 13 |  | I4 |
| 2 | 24V (Sensor) | 14 |  | |
| 3.4 | GND | 15 |  | Q3 (M2) |
| 19 | Conveyor belt | 16 |  | |
| 3.4 | GND | 17 |  | Q4 (M3) |
| 20 | Saw | 18 |  | |
| | not assigned | 19 | | |
| | not assigned | 20 |  | |

ST2

| | | | | |
|-----|---------------------|----|---|--------------------|
| | not assigned | 1 |  | |
| | not assigned | 2 |  | |
| 21 | Retract oven feeder | 3 |  | Q5/Q6 (M4) |
| 22 | Extend oven feeder | 4 |  | |
| 10 | Oven feeder inside | 5 |  | I6 |
| 2 | 24V (Sensor) | 6 |  | |
| 11 | Oven feeder outside | 7 |  | I7 |
| 2 | 24V (Sensor) | 8 |  | |
| 12 | Vacuum on oven | 9 | | I8 |
| 2 | 24V (Sensor) | 10 |  | |
| 23 | Vacuum to oven | 11 |  | Q7/Q8 (M5) |
| 24 | Vacuum to turntable | 12 |  | |
| 3.4 | GND | 13 |  | Q9 (oven light) |
| 25 | Lamp kiln | 14 |  | |
| 3.4 | GND | 15 |  | Q10 (compressor) |
| 26 | Compressor | 16 |  | |
| 13 | Oven light barrier | 17 |  | I9 |
| 2 | 24V (Sensor) | 18 |  | |
| 3.4 | GND | 19 | | |
| 2 | 24V (Sensor) | 20 |  | Light barrier lamp |

3.4
27
3.4
28
3.4
29
3.4
30

| |
|-------------|
| Terminal V1 |
| Terminal V2 |
| Terminal V3 |
| Terminal V4 |

| |
|-----------------------|
| Q11 (Valve vacuum) |
| Q12 (lower valve) |
| Q13 (oven door valve) |
| Q14 (feeder valve) |

red = power supply
yellow = Motor poles reversible via relay



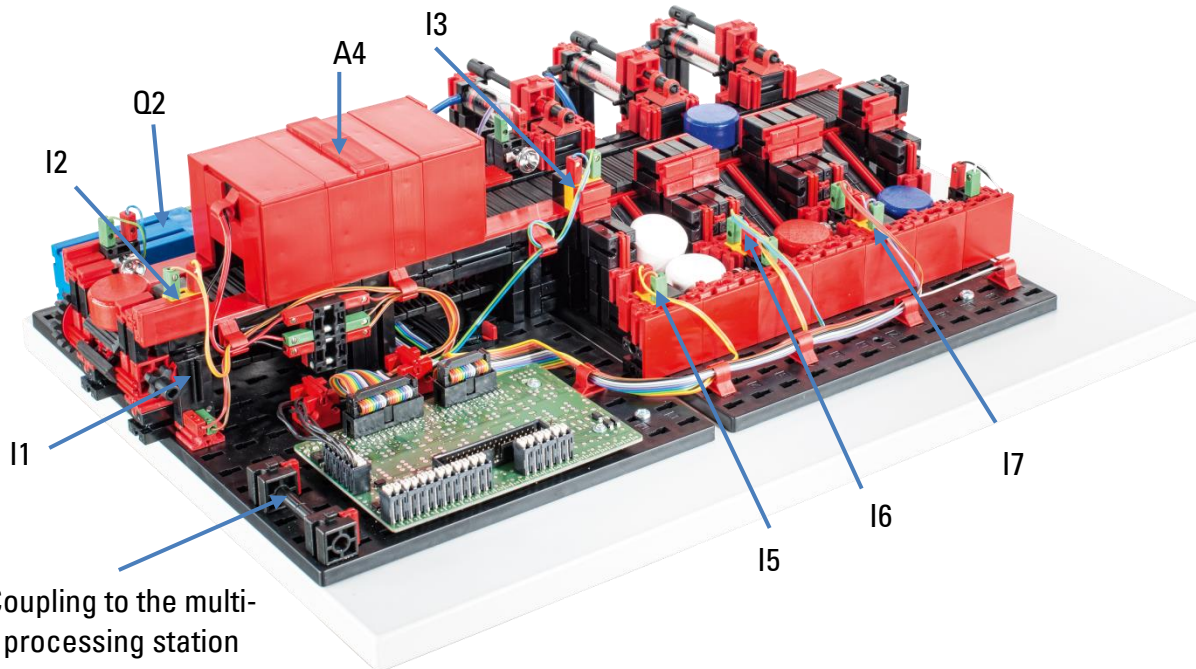









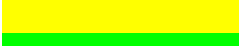
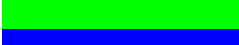







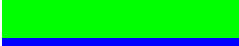





Assignment plan for the sorting line using colour recognition (SLD)

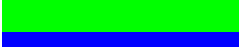

Not shown: Q1, Q3, Q4, Q5

| Terminal no. (ST1) | Function | Designation | Clamp SPS | I/O address S7-1500 | Variable name S7-1500 |
|--------------------|-----------------------------------|---------------------------|-----------|---------------------|---|
| 1 | Power supply (+) actuators | 24V DC | | | |
| 2 | Power supply (+) sensors | 24V DC | | | |
| 3 | Power supply (-) | 0V | | | |
| 4 | Power supply (-) | 0V | | | |
| 5 | Pulse key | I1 | DI3.0 | %I3.0 | IX_SLD_PulseCounter_I1 |
| 6 | Light barrier input | I2 | DI3.1 | %I3.1 | IX_SLD_LightBarrierInlet_I2 |
| 7 | Light barrier after colour sensor | I3 | DI3.2 | %I3.2 | IX_SLD_LightBarrierBehindColorSensor_I3 |
| 9 | Colour sensor | A4 Analogue 0-10VDC | AI1.0 | %IW7 | IW_SLD_ColorSensor_A4 |
| 10 | Light barrier white | I5 | DI3.3 | %I3.3 | IX_SLD_LightBarrierWhite_I5 |
| 11 | Light barrier red | I6 | DI3.4 | %I3.4 | IX_SLD_LightBarrierRed_I6 |
| 12 | Light barrier blue | I7 | DI3.5 | %I3.5 | IX_SLD_LightBarrierBlue_I7 |
| 17 | Motor conveyor belt | Q1 | D05.0 | %Q5.0 | QX_SLD_M1_ConveyorBelt_Q1 |
| 18 | Compressor | Q2 | D05.1 | %Q5.1 | QX_SLD_Compressor_Q2 |
| 20 | Valve first ejector (white) | Q3 | D05.2 | %Q5.2 | QX_SLD_ValveFirstEjectorWhite_Q3 |
| 21 | Valve second ejector (red) | Q4 | D05.3 | %Q5.3 | QX_SLD_ValveSecondEjectorRed_Q4 |
| 22 | Valve third ejector (blue) | Q5 | D05.4 | %Q5.4 | QX_SLD_ValveThirdEjectorBlue_Q5 |

Model wiring

| Terminal | Header ST1 | | Ribbon cable | Sensors + actuators model |
|----------|-----------------------------------|----|---|---------------------------------|
| 5 | Pulse key | 1 |  | I1 |
| 2 | 24V (Sensor) | 2 |  | |
| 6 | Light barrier input | 3 |  | I2 |
| 2 | 24V (Sensor) | 4 |  | |
| 7 | Light barrier after colour sensor | 5 |  | I3 |
| 2 | 24V (Sensor) | 6 |  | |
| 3.4 | GND | 7 |  | Q2 (compressor) |
| 18 | Compressor | 8 |  | |
| 3.4 | GND | 9 | | Q1 (Conveyor belt) |
| 17 | Conveyor belt | 10 |  | |
| 3.4 | GND | 11 |  | Colour sensor (A4) |
| 2 | 9V (generated from 24V) | 12 |  | |
| 9 | Colour sensor (0-10V) | 13 |  | |
| | not assigned | 14 |  | |
| 3.4 | GND | 15 |  | Light barrier lamp |
| 2 | 24V (Sensor) | 16 |  | |
| 3.4 | GND | 17 |  | Light barrier lamp |
| 2 | 24V (Sensor) | 18 |  | |
| | not assigned | 19 | | |
| | not assigned | 20 |  | |
| | Header ST2 | | | |
| | not assigned | 1 |  | |
| | not assigned | 2 |  | |
| 10 | Light barrier white | 3 |  | I5 |
| 2 | 24V (Sensor) | 4 |  | |
| 12 | Light barrier blue | 5 |  | I7 |
| 2 | 24V (Sensor) | 6 |  | |
| 11 | Light barrier red | 7 |  | I6 |
| 2 | 24V (Sensor) | 8 |  | |
| 3.4 | GND | 9 | | Light barrier lamp |
| 2 | 24V (Sensor) | 10 |  | |
| 3.4 | GND | 11 |  | Light barrier lamp |
| 2 | 24V (Sensor) | 12 |  | |
| 3.4 | GND | 13 |  | Light barrier lamp |
| 2 | 24V (Sensor) | 14 |  | |
| 3.4 | Terminal V1 | | | Q3 (Valve first ejector, white) |
| 20 | | | | |
| 3.4 | Terminal V2 | | | Q4 (Valve second ejector, red) |
| 21 | | | | |
| 3.4 | Terminal V3 | | | Q5 (Valve third ejector, blue) |
| 22 | | | | |

red = power supply

Assignment plan for sensor station with surveillance camera (SSC)

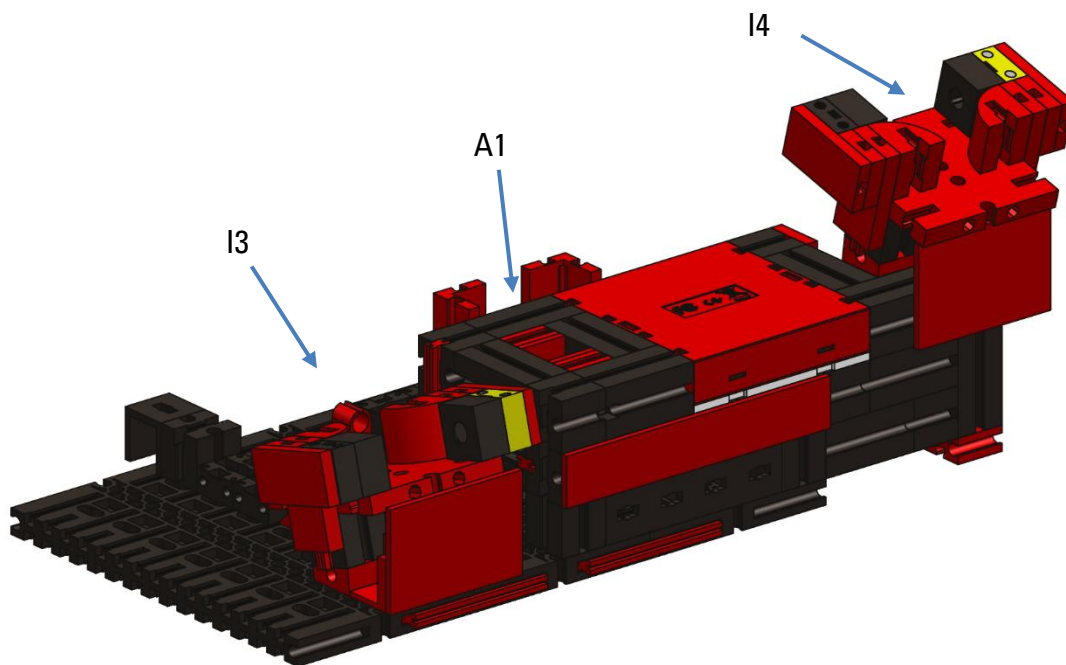
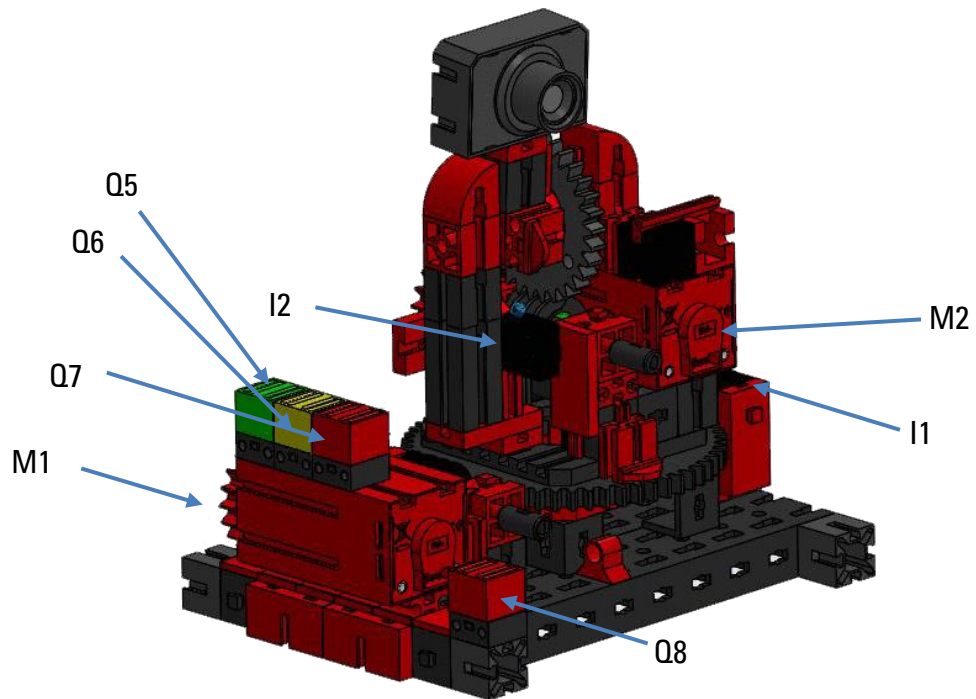

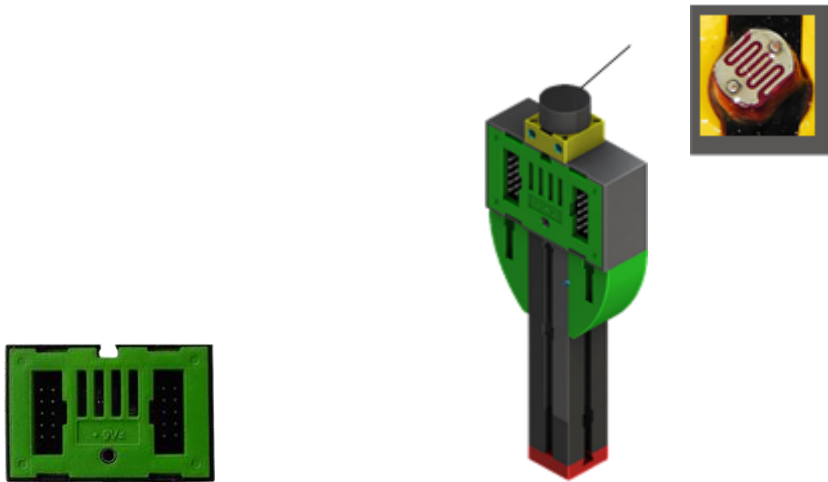

Environmental sensor Photo-resistor

The NFC reader is connected to the TXT controller via the I²C interface.
The mounted surveillance camera is connected to the TXT Controller via a USB interface.
Data from the environmental sensor and photo-resistor is also read in by the TXT Controller.



TXT-Controller (TxtGatewayPLC)

| Terminal no. (ST1) | Function | Designation | Clamp SPS | I/O address S7-1500 | Variable name S7-1500 |
|--------------------|----------------------------|---------------------------|-----------|---------------------|--|
| 1 | Power supply (+) actuators | 24V DC | | | |
| 2 | Power supply (+) sensors | 24V DC | | | |
| 3 | Power supply (-) | 0V | | | |
| 4 | Power supply (-) | 0V | | | |
| 5 | Reference switch 1 | I1 | DI4.0 | %I4.0 | IX_SSC_RefSwitchVerticalAxis_I1 |
| 6 | Reference switch 2 | I2 | DI4.1 | %I4.1 | IX_SSC_RefSwitchHorizontalAxis_I2 |
| 7 | Light barrier outsourcing | I3 | DI4.2 | %I4.3 | IX_SSC_LightBarrierStorage_I3 |
| 8 | Light barrier storage | I4 | DI4.3 | %I4.2 | IX_SSC_LightBarrierOutsourcing_I4 |
| 9 | Colour sensor | A1 Analogue 0-10VDC | AI1.1 | %IW9 | IW_SSC_ColorSensor_A1 |
| 11 | Encoder vertical pulse 1 | B1 | DI5.3 | %I5.3 | IX_SSC_EncoderVerticalAxisImp1_B1 |
| 12 | Encoder vertical pulse 2 | B2 | DI5.7 | %I5.7 | IX_SSC_EncoderVerticalAxisImp2_B2 |
| 13 | Encoder horizontal pulse 1 | B3 | DI6.3 | %I6.3 | IX_SSC_EncoderHorizontalAxisImp1_B3 |
| 14 | Encoder horizontal pulse 2 | B4 | DI6.7 | %I6.7 | IX_SSC_EncoderHorizontalAxisImp2_B4 |
| 19 | Vertical motor up | Q1 (M1) | DO6.0 | %Q6.0 | QX_SSC_M1_VerticalAxisUp_Q1 |
| 20 | Vertical motor down | Q2 (M1) | DO6.1 | %Q6.1 | QX_SSC_M1_VerticalAxisDown_Q2 |
| 21 | Turn motor anti-clockwise | Q4 (M2) | DO6.2 | %Q6.2 | QX_SSC_M2_HorizontalAxisCounter clockwise_Q4 |
| 22 | Turn motor clockwise | Q3 (M2) | DO6.3 | %Q6.3 | QX_SSC_M2_HorizontalAxisClockwise_Q3 |
| 23 | LED green | Q5 | DO6.4 | %Q6.4 | QX_SSC_LED_Green_Q5 |
| 24 | LED yellow | Q6 | DO6.5 | %Q6.5 | QX_SSC_LED_Yellow_Q6 |
| 25 | LED red | Q7 | DO6.6 | %Q6.6 | QX_SSC_LED_Red_Q7 |
| 26 | LED red online status | Q8 | DO6.7 | %Q6.7 | QX_SSC_LED_Red_Online_Q8 |
| 27 | PWM vertical | PWM (M1) | DO9.2 | %QW27 | QW_SSC_PWM_Vertical_M1 |
| 28 | PWM cantilever | PWM (M2) | DO9.3 | %QW29 | QW_SSC_PWM_Horizontal_M2 |









Model wiring

Stiftleiste ST1

Klemme

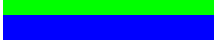









| | | |
|-----|----------------------------|----|
| 5 | Referenz Kamera vertikal | 1 |
| 2 | 24V (Sensor) | 2 |
| 19 | Kamera hoch | 3 |
| 20 | Kamera runter | 4 |
| 3,4 | GND | 5 |
| 2 | 24V (Sensor) | 6 |
| 11 | A | 7 |
| 12 | B | 8 |
| 6 | Referenz Kamera horizontal | 9 |
| 2 | 24V (Sensor) | 10 |

Flachbandkabel Sensoren/Aktoren am Modell

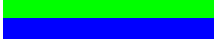
| | |
|--|---------------------|
|  | I1 |
|  | Q1/Q2 (M1) |
|  | |
|  | Encoder vertikal |
|  | |
|  | Spannungsversorgung |
|  | Signal A |
|  | Signal B |
|  | I2 |
|  | |





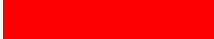



Stiftleiste ST2

| | | |
|-----|-----------------|----|
| 21 | Kamera links | 1 |
| 22 | Kamera rechts | 2 |
| 3,4 | GND | 3 |
| 2 | 24V (Sensor) | 4 |
| 13 | A | 5 |
| 14 | B | 6 |
| 3,4 | GND | 7 |
| 23 | LED grün | 8 |
| 3,4 | GND | 9 |
| 24 | LED gelb | 10 |
| 3,4 | GND | 11 |
| 25 | LED rot | 12 |
| 3,4 | GND | 13 |
| 26 | LED rot(Kamera) | 14 |

| | |
|--|---------------------|
|  | Q3/Q4(M2) |
|  | |
|  | Encoder horizontal |
|  | Spannungsversorgung |
|  | Signal A |
|  | Signal B |
|  | Q5 LED grün |
|  | |
|  | Q6 LED gelb |
|  | |
|  | Q7 LED rot |
|  | |
|  | Q8 LED rot (Kamera) |

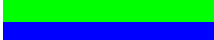
Stiftleiste ST3

| | | |
|-----|-----------------------------|----|
| 3,4 | GND | 1 |
| 2 | 9V (Aus 24V Sensor erzeugt) | 2 |
| 7 | Lichtschanke Auslagerung | 3 |
| 2 | 24V (Sensor) | 4 |
| 3,4 | GND | 5 |
| 2 | 24V (Sensor) | 6 |
| 8 | Lichtschanke Einlagerung | 7 |
| 2 | 24V (Sensor) | 8 |
| 9 | Farbsensor | 9 |
| | nicht belegt | 10 |

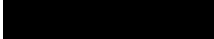
| | |
|--|-------------------------|
|  | Spannungsversorgung |
|  | Farbsensor |
|  | I3 |
|  | |
|  | Lampen für Lichtschanke |
|  | |
|  | I4 |
|  | |
|  | I5 |
|  | |
|  | - |

Programming tasks

In order to handle programming tasks, you will require prior knowledge of the programming language Structured Text (ST or SCL) and on how to handle the programming tool you are using.

The provided programming solutions have been created with the TIA Portal V16 for a programmable controller SIMATIC S7-1500 with CPU1512SP

Alternatively, other control systems can also be used with appropriate software.

An introduction to programming with the TIA Portal is available, for instance, here from SIEMENS:

<http://www.siemens.com/sce/S7-1500>

<https://new.siemens.com/global/en/company/sustainability/education/sce/learning-training-documents/advanced-programming.html>

Further information is available at:

<https://github.com/fischertechnik>

The global fischertechnik library **Library_LearningFactory_4_0_24V** and program solutions are available at:

https://github.com/fischertechnik/plc_training_factory_24v

Programming task 1:

Configuring and commissioning the SIMATIC controller with CPU1512SP

Task:

The complete hardware configuration for the controller must be created, loaded and tested for the LearningFactory_4.0_24V, with all input and output modules.

A non-specified CPU will be created in order to determine all components.

This project with hardware configuration serves as the basis for all subsequent programming tasks.

Planning

1. Wire a START button as normally open contact (NO) and a STOP button as normally closed contact (NC) to two free inputs on the controller. Connect the LearningFactory_4_0_24V to the PLC and switch on the controller.
2. Create the project **LearningFactory_4_0_24V_Task01_HWConf** in the TIA portal.
3. In the TIA portal project **LearningFactory_4_0_24V_Task01_HWConf**, add a controller **SIMATIC ET 200SP CPU** or **SIMATIC S7-1500** as a new device. Do so as a non-specified CPU, as described in the following programming information.
4. Connect the programming device to the CPU and determine the configuration of the connected device according to the programming information.
5. Set the input/output addresses of the detected modules according to the programming information and configure the module.
6. As shown in the programming information, dearchive the global library **Library_LearningFactory_4_0_24V**, and from there insert the global **Start-Stop** variable table into your project.
7. Load and test the hardware configuration with variable table into the controller.
8. Create an observation table named **Beobachtungstabelle_watch table**, insert signals from the global variable table there and check it by monitoring the button functions.
9. Save and archive the project **LearningFactory_4_0_24V_Task01_HWConf**.

Programming information:

Information on connecting the START and STOP buttons:

Two buttons are required for the following programming tasks. A START button as a NO contact (**N**ormally**O**pen) and a STOP button as a NC contact (**N**ormally**C**losed). Fischertechnik mini-buttons can be used for this purpose.

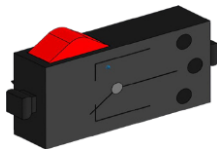

The mini-buttons are equipped with changeover contacts and can be used as both normally closed and normally open contacts. The figure shows a circuit diagram of the mini-pushbuttons.

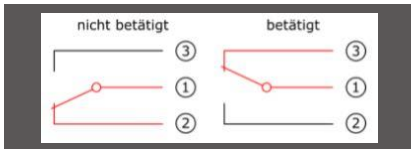

Contacts 1 and 2 are wired to a digital input on the PLC for use as NC contacts (**N**ormally**C**losed).
 Contacts 1 and 3 are wired to a digital input on the PLC for use as NO contacts (**N**ormally**O**pen).

Details on connecting SIMATIC assemblies are provided in the handbooks.

Here is an example of connecting the digital input module DI 16x24VDC ST to the BaseUnit BU type A0 without AUX terminal (1-wire connection):

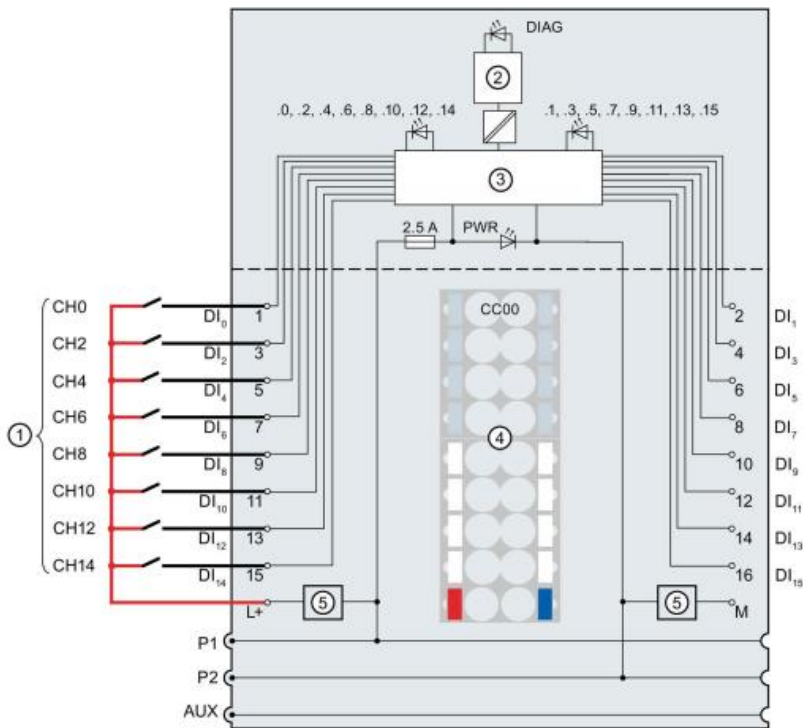

Information on configuring a non-specified CPU1512SP:

Before a SIMATIC S7-1500 PLC can be configured, its hardware must be configured.

The fastest way to do so is to create a non-specified CPU and then have all components detected.

To do so, the programming device must be connected to the controller via Ethernet, and the IP addresses must be set so that both devices are in the same subnet.

Setting the IP address is described in this document in the section **Commissioning and adjusting the SIMATIC controller CPU1512SP**.

The configuration for our Training Factory Industry 4.04.0 can be completed using the following steps.

→ First, start the Totally Integrated Automation Portal by double clicking on it. (→ **TIA Portal V16**)



→ In the portal view, click → **Start** → and then **Create new project**. Change the project name, path, author and comment accordingly and then click → **Create**

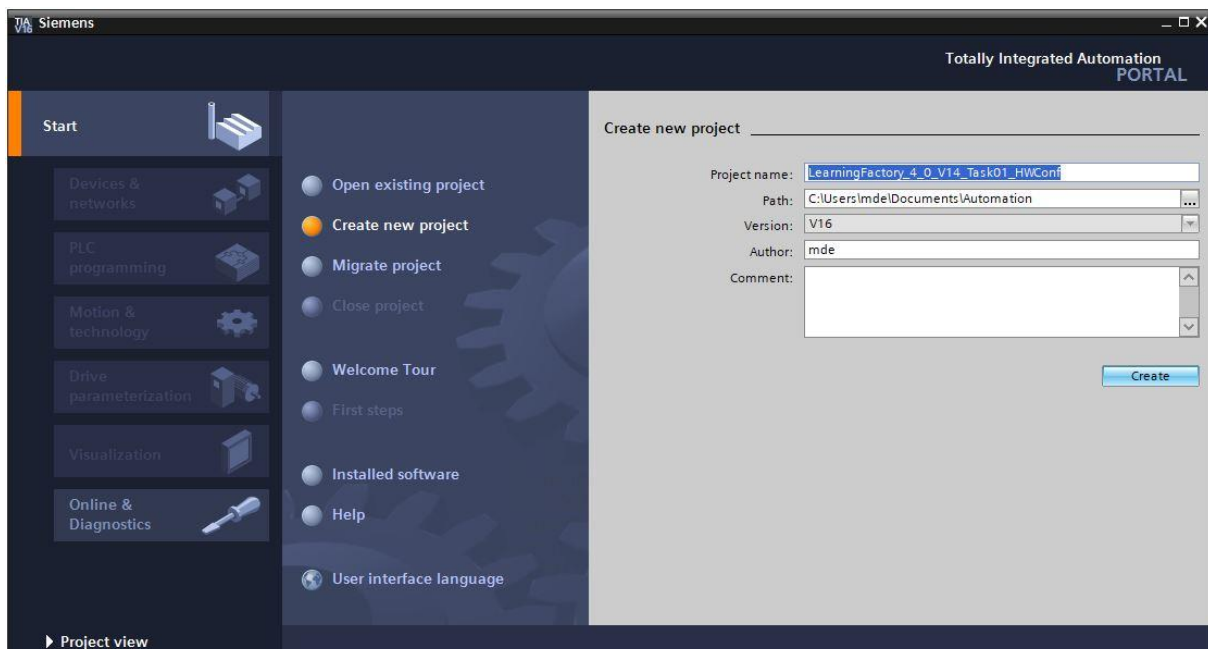

→ Then select → **Start** → **Devices & Networks** → and **Add new device** in the portal.

Create a new CPU. To do so, use a non-specified model of the **SIMATIC ET200 CPU** with order number **6ES7 5XX-XXXX-XXXX**.

(Controller → SIMATIC ET200 CPU → ET 200SPCPU → Non-specified ST200SP CPU → 6ES7 5XX-XXXX-XXXX → V2.8)

Assign a device name (device name → **PLC**), select **Open device view** and then click → **Add**.

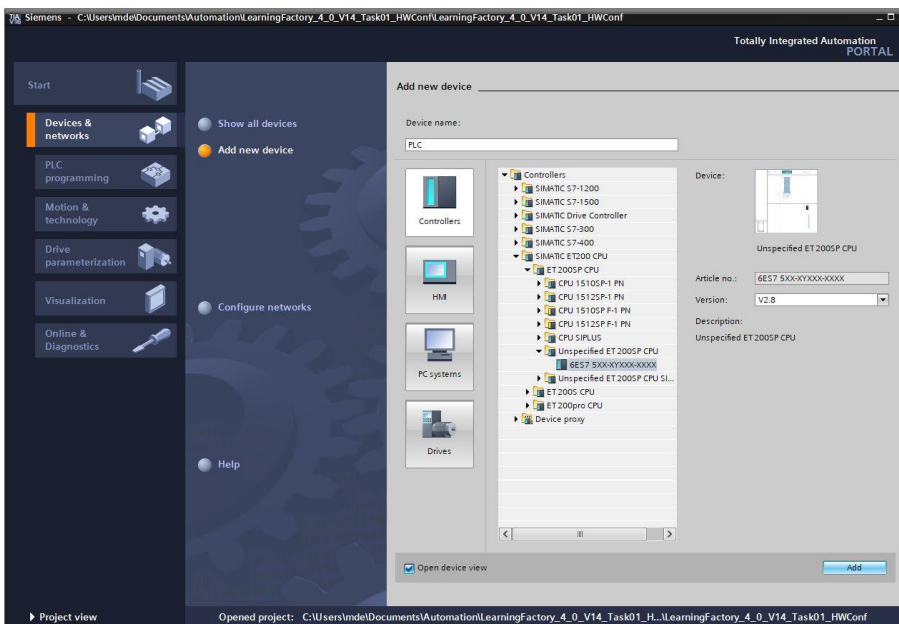

→ The TIA Portal will switch automatically to the project view, and will display a notification that this device is not specified. To have the hardware configuration identified automatically, start the detection by clicking **Identify** in the yellow info box. (→ identify)

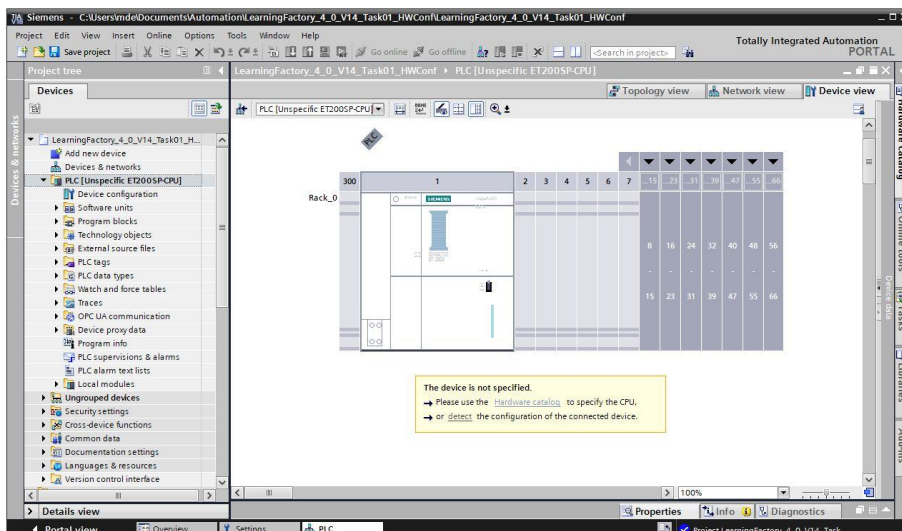

→ First, select the type of PG/PC interface you are using and the network card you want to use to create a connection to the PLC via Ethernet. (→ **Type of PG/PC interface: PN/IE** → **PG/PC interface: Intel(R) Ethernet ...**)

Now, start the search for devices on the network by clicking the → **Start search** button

Then, all available devices will be detected and listed. If you have selected the right CPU, then clicking → **Detect** will cause the CPU in question and connected modules to be detected.

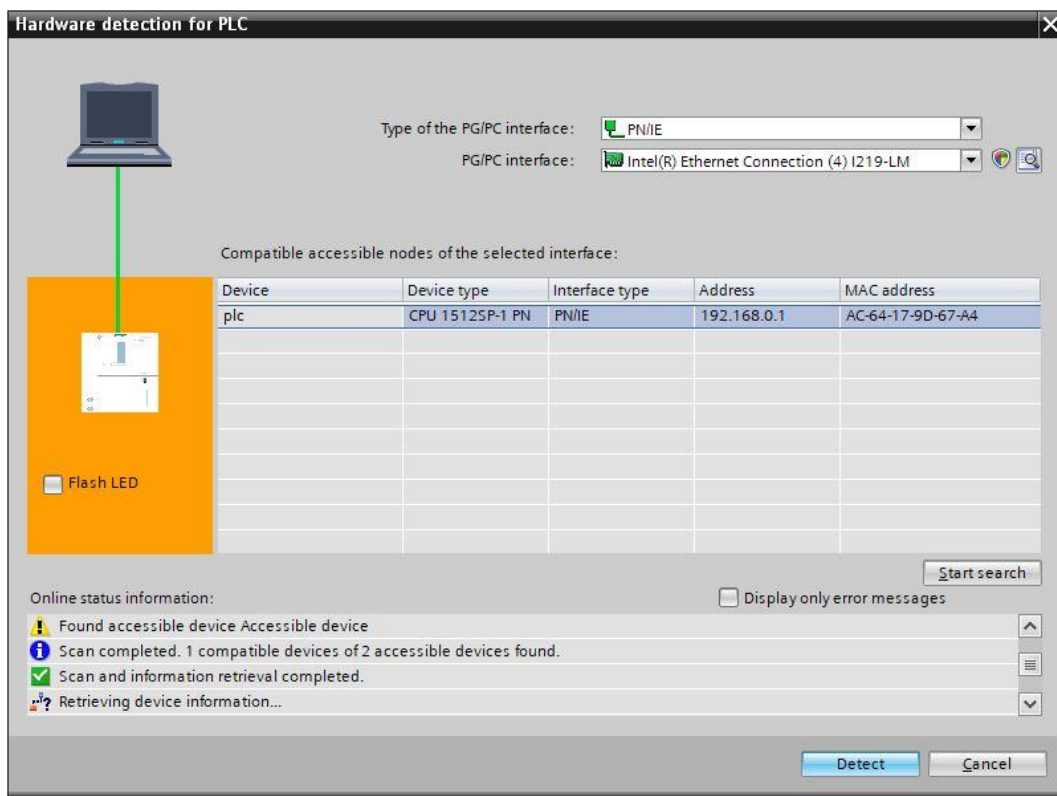

Note: If your CPU is not in the list, ensure you have selected the right network card and that your laptop and CPU are connected.

→ The TIA portal will now show the complete device configuration for the selected CPU. Now, you can configure the CPU and the input/output assemblies according to your specifications.

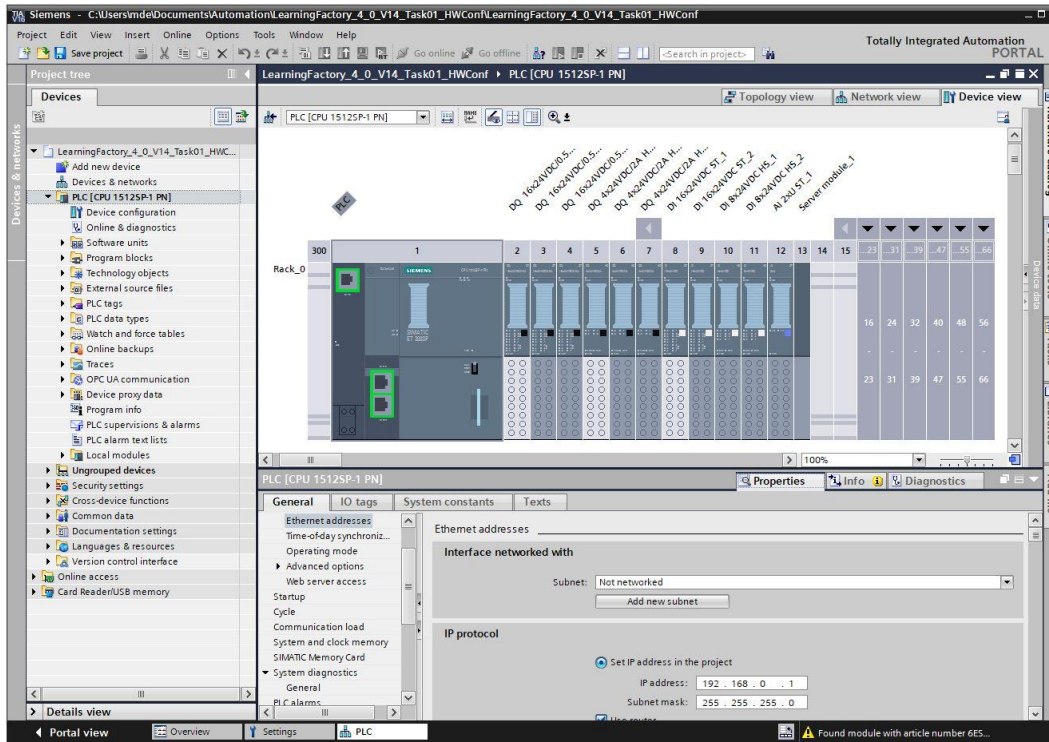

Information on configuring the input/output assemblies

The addresses of the assemblies should be set as shown here.

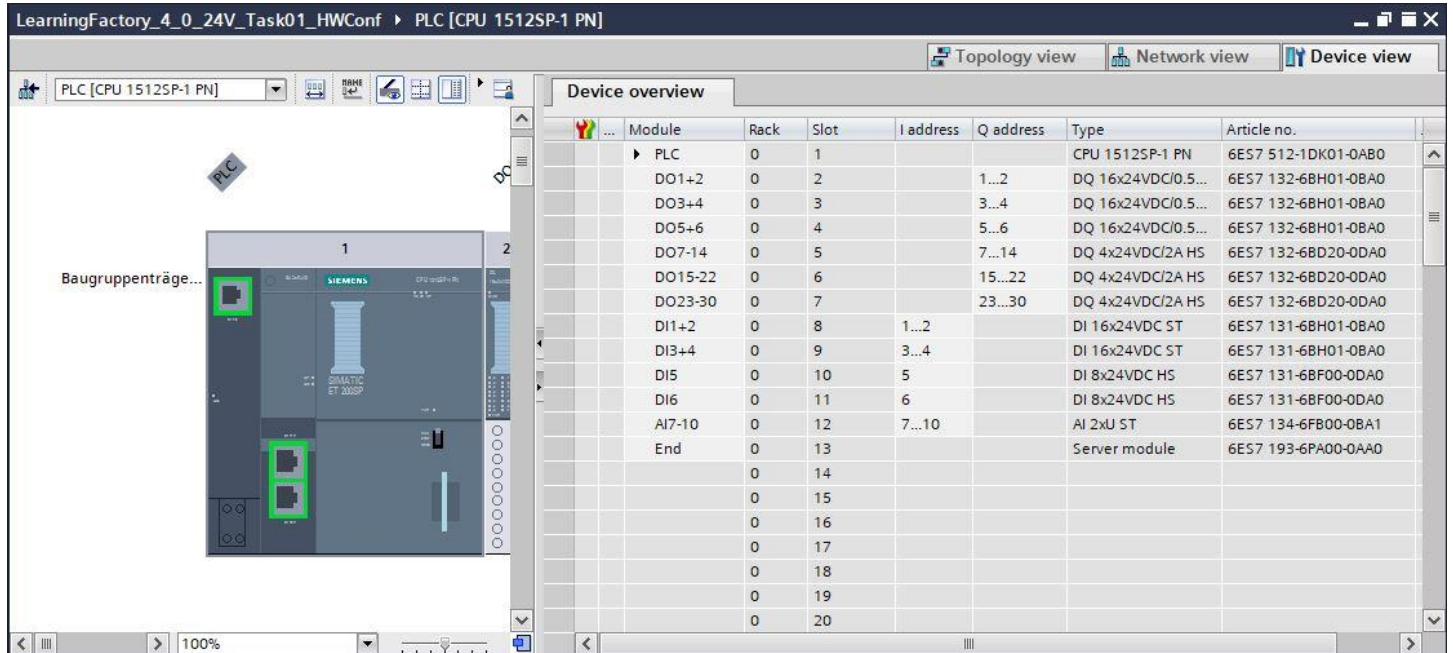

The screenshot shows the 'Device overview' table in SIMATIC Manager. The rack configuration is as follows:

| Module | Rack | Slot | I address | Q address | Type | Article no. |
|---------|------|------|-----------|-----------|--------------------|---------------------|
| PLC | 0 | 1 | | | CPU 1512SP-1 PN | 6ES7 512-1DK01-0AB0 |
| DO1+2 | 0 | 2 | | 1...2 | DQ 16x24VDC/0.5... | 6ES7 132-6BH01-0BA0 |
| DO3+4 | 0 | 3 | | 3...4 | DQ 16x24VDC/0.5... | 6ES7 132-6BH01-0BA0 |
| DO5+6 | 0 | 4 | | 5...6 | DQ 16x24VDC/0.5... | 6ES7 132-6BH01-0BA0 |
| DO7-14 | 0 | 5 | | 7...14 | DQ 4x24VDC/2A HS | 6ES7 132-6BD20-0DA0 |
| DO15-22 | 0 | 6 | | 15...22 | DQ 4x24VDC/2A HS | 6ES7 132-6BD20-0DA0 |
| DO23-30 | 0 | 7 | | 23...30 | DQ 4x24VDC/2A HS | 6ES7 132-6BD20-0DA0 |
| DI1+2 | 0 | 8 | 1...2 | | DI 16x24VDC | 6ES7 131-6BH01-0BA0 |
| DI3+4 | 0 | 9 | 3...4 | | DI 16x24VDC ST | 6ES7 131-6BH01-0BA0 |
| DI5 | 0 | 10 | 5 | | DI 8x24VDC HS | 6ES7 131-6BF00-0DA0 |
| DI6 | 0 | 11 | 6 | | DI 8x24VDC HS | 6ES7 131-6BF00-0DA0 |
| AI7-10 | 0 | 12 | 7...10 | | AI 2xU ST | 6ES7 134-6FB00-0BA1 |
| End | 0 | 13 | | | Server module | 6ES7 193-6PA00-0AA0 |
| | 0 | 14 | | | | |
| | 0 | 15 | | | | |
| | 0 | 16 | | | | |
| | 0 | 17 | | | | |
| | 0 | 18 | | | | |
| | 0 | 19 | | | | |
| | 0 | 20 | | | | |

Pulse width modulation (PWM) should be set as the **operating mode** for the output modules with addresses DO 7 - DO 30.

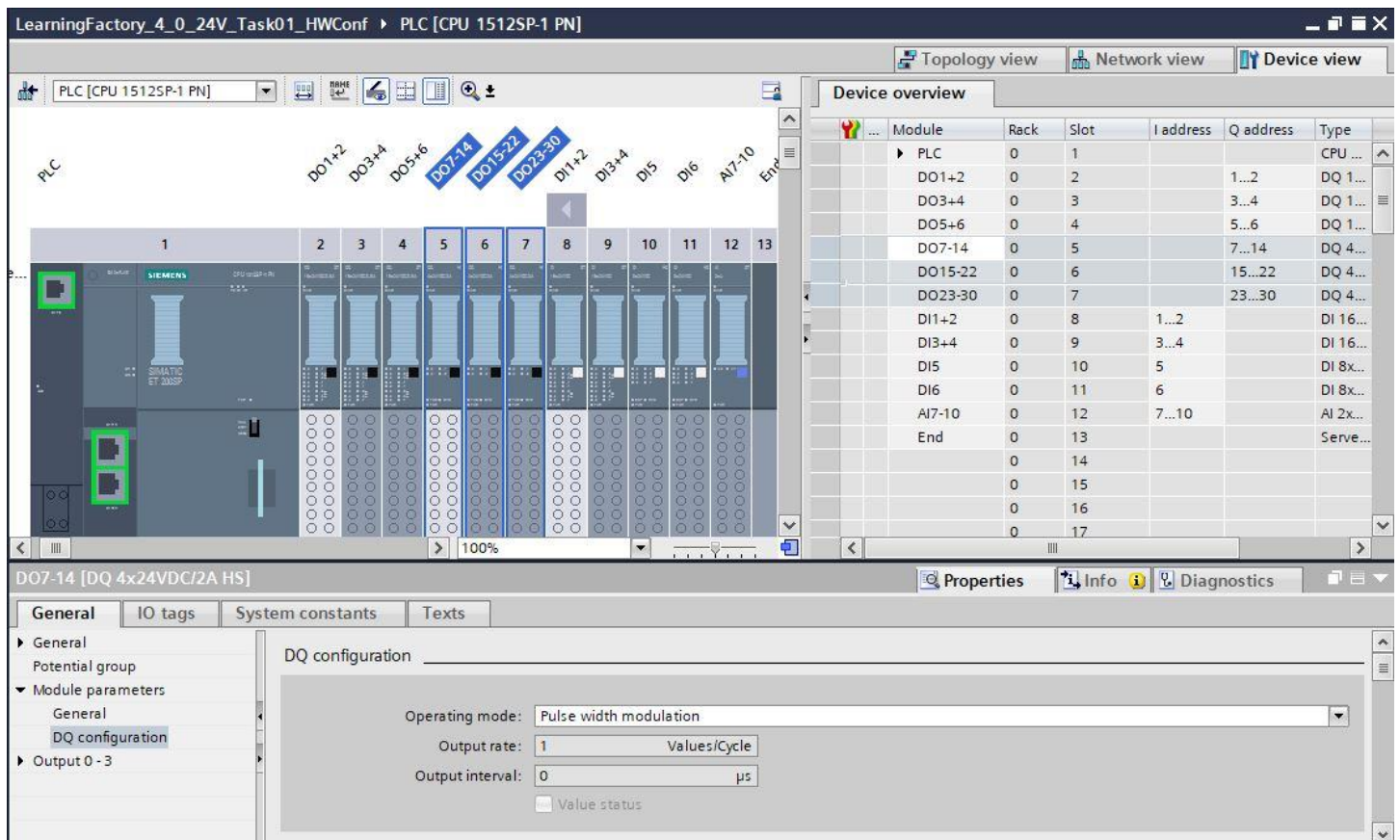

The screenshot shows the 'DQ configuration' dialog for module DO7-14. The 'Operating mode' is set to 'Pulse width modulation'. The 'Output rate' is set to 1 Values/Cycle and the 'Output interval' is set to 0 µs.

DQ configuration

- Operating mode: Pulse width modulation
- Output rate: 1 Values/Cycle
- Output interval: 0 µs
- Value status

Operating mode DI \ Oversampling should be set for the input modules with addresses DI 5 to DI 6 for the encoder inputs.

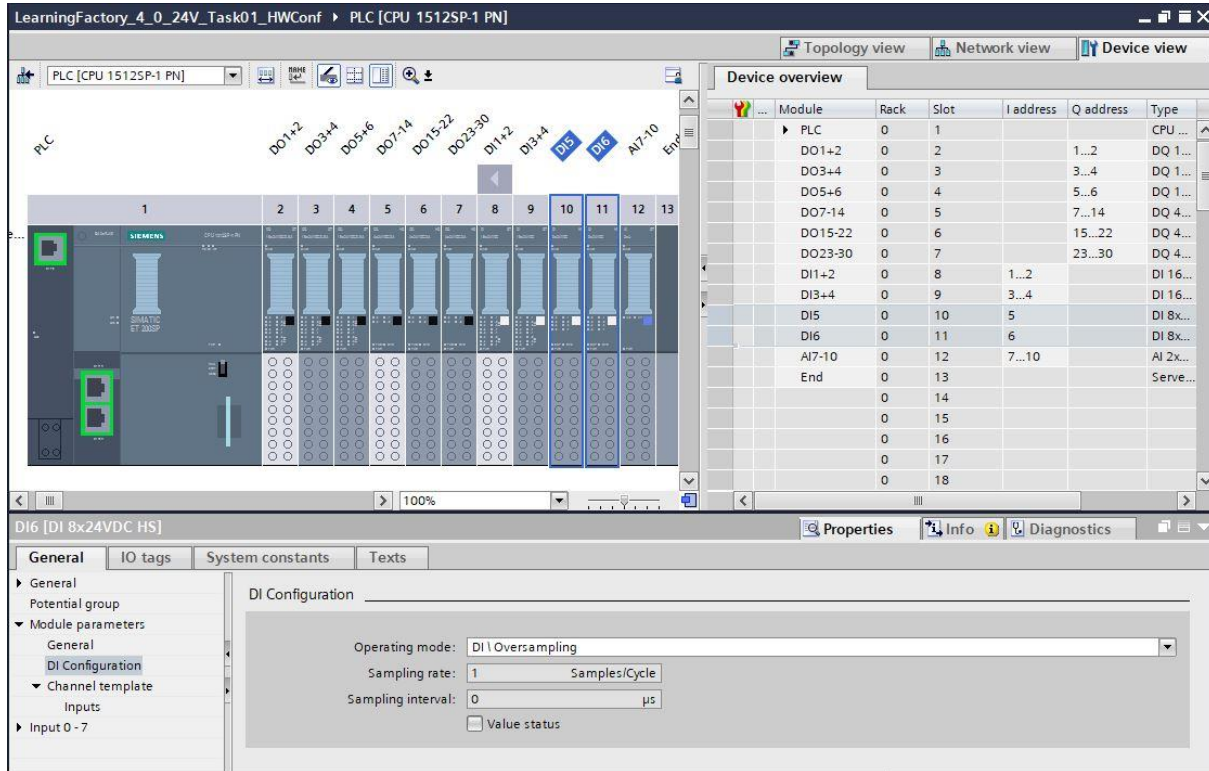

The screenshot shows the SIMATIC Manager interface for a PLC [CPU 1512SP-1 PN]. The main window displays a rack of modules from slot 1 to 13. The 'Device overview' table on the right lists the modules and their addresses. The 'Properties' window for the 'DI6 [DI 8x24VDC HS]' module is open, showing the 'DI Configuration' tab. The 'Operating mode' is set to 'DI \ Oversampling', the 'Sampling rate' is '1 Samples/Cycle', and the 'Sampling interval' is '0 µs'. The 'Value status' checkbox is unchecked.

| Module | Rack | Slot | I address | Q address | Type |
|---------|------|------|-----------|-----------|----------|
| PLC | 0 | 1 | | | CPU ... |
| DO1+2 | 0 | 2 | | 1...2 | DQ 1... |
| DO3+4 | 0 | 3 | | 3...4 | DQ 1... |
| DO5+6 | 0 | 4 | | 5...6 | DQ 1... |
| DO7-14 | 0 | 5 | | 7...14 | DQ 4... |
| DO15-22 | 0 | 6 | | 15...22 | DQ 4... |
| DO23-30 | 0 | 7 | | 23...30 | DQ 4... |
| DI1+2 | 0 | 8 | 1...2 | | DI 16... |
| DI3+4 | 0 | 9 | 3...4 | | DI 16... |
| DI5 | 0 | 10 | 5 | | DI 8x... |
| DI6 | 0 | 11 | 6 | | DI 8x... |
| AI7-10 | 0 | 12 | 7...10 | | AI 2x... |
| End | 0 | 13 | | | Serve... |

The measurement type voltage should be set with a measurement range of 0-10V for the channels of the analogue input modules.

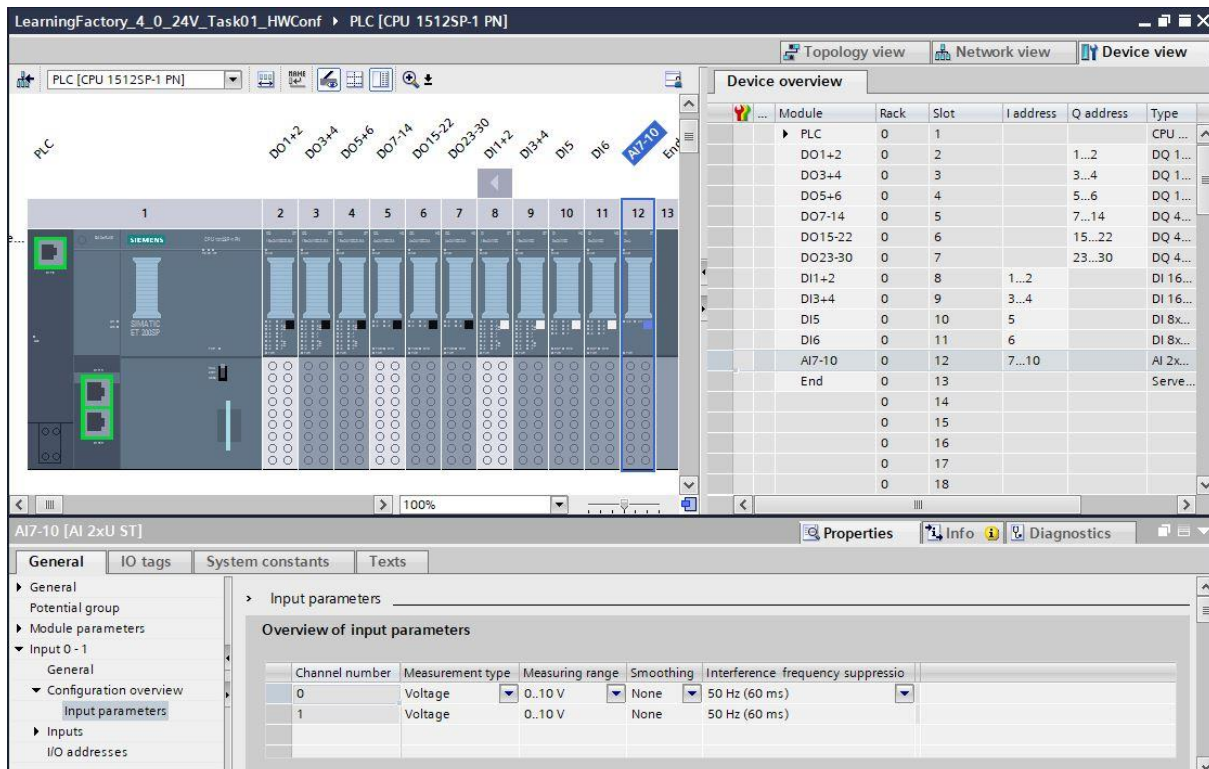

The screenshot shows the SIMATIC Manager interface for a PLC [CPU 1512SP-1 PN]. The main window displays a rack of modules from slot 1 to 13. The 'Device overview' table on the right lists the modules and their addresses. The 'Properties' window for the 'AI7-10 [AI 2xU ST]' module is open, showing the 'Input parameters' tab. The 'Overview of input parameters' table shows the configuration for two channels.

| Channel number | Measurement type | Measuring range | Smoothing | Interference frequency suppression |
|----------------|------------------|-----------------|-----------|------------------------------------|
| 0 | Voltage | 0..10 V | None | 50 Hz (60 ms) |
| 1 | Voltage | 0..10 V | None | 50 Hz (60 ms) |

Information on global libraries:

The global variable tables and a module for encoder evaluation in a compressed library **Library_LearningFactory_4_0_24V.zal16** are provided for programming tasks.

This can be opened by clicking on the  symbol in **Global Libraries** to open a library, then selecting the file **Library_LearningFactory_4_0_24V.zal16**.

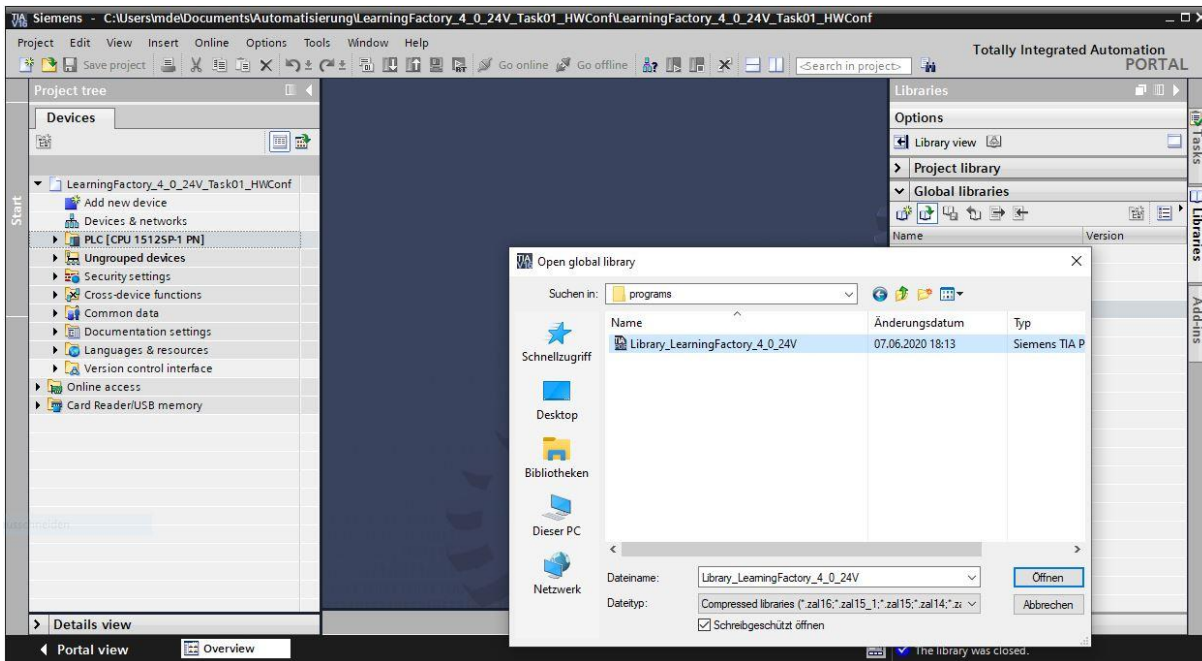

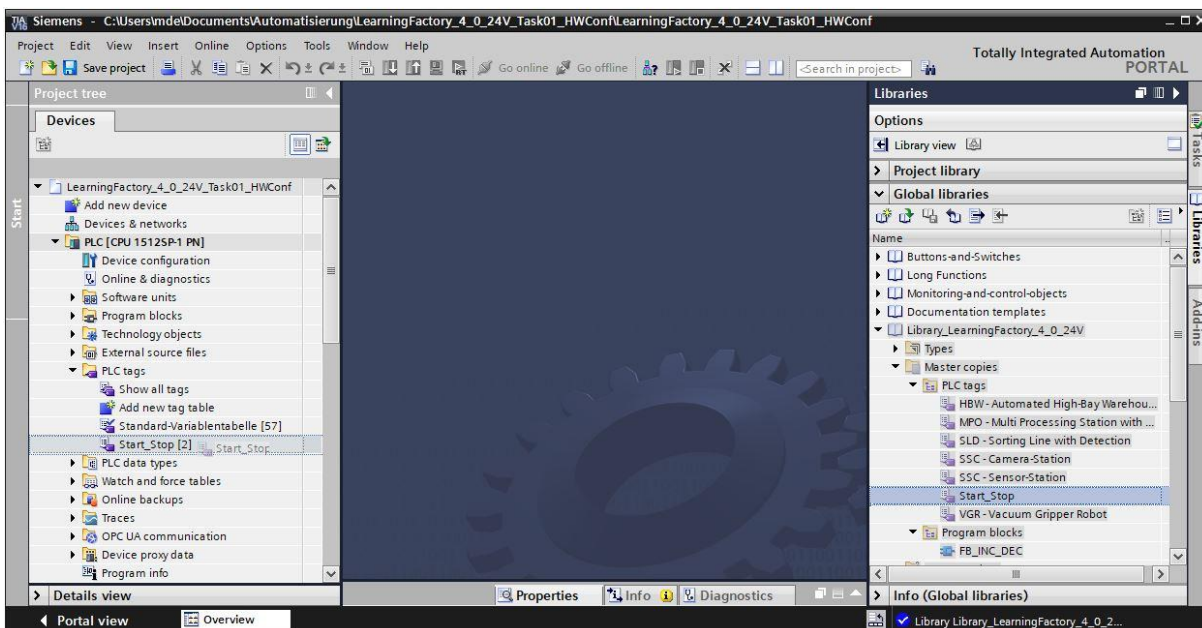

Elements from the library can then simply be copied to the relevant project folder via drag & drop.

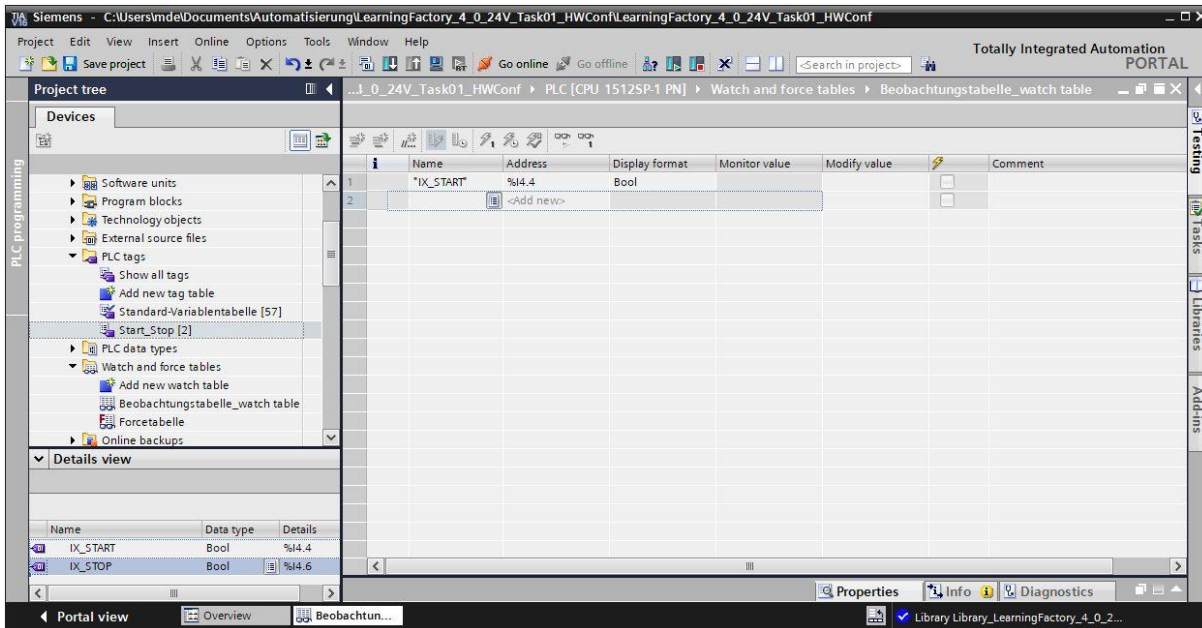

Information on observation tables:

Observation tables can be created to test the function of factory modules and to determine position values later on. Variables can then easily be moved to the **observation tables** via drag & drop from the detailed view of variable tables.



In the expanded view , the inputs and outputs used in the program can also be controlled  continuously. If there are no buttons for the START and STOP functions, then these can be simulated in this manner.

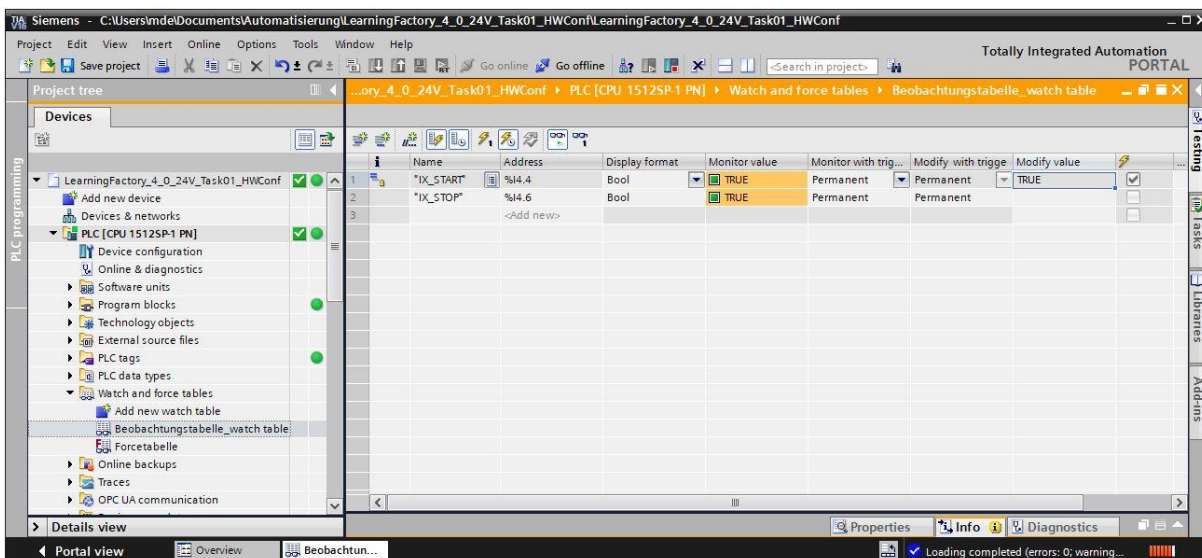

Programming task 2:

Sensor station with camera (SSC), colour detection with colour sensor

Task:

The colour sensor on the input/output station should be used in the sensor station with camera (SSC) to detect different blue/white/red workpieces.

When there is a workpiece on the colour sensor, the measured value of the colour sensor is evaluated, and the result is displayed on an assigned LED. The evaluation only runs for as long as the START button is pressed.

Colour assignment:

| | |
|--------------------|----------------------------|
| Blue | green LED (Q5) |
| White | yellow LED (Q6) |
| Red | red LED (Q7) |
| No colour detected | red LED online status (Q8) |

The program should be created in the programming language Structured Text (ST or SCL).

Planning

1. In the TIA Portal, open the project **LearningFactory_4_0_24V_Task01_HWConf** and save it under the name **LearningFactory_4_0_24V_Task02_SensorsSSC**.
2. Copy the global variable table **SSC Sensor Station**, as shown in programming task 1, from the library **Library_LearningFactory_4_0_24V** and insert it into your project.
3. As shown in programming task 1, expand the observation table, determine value ranges for the 3 colours blue/white/red there by placing the different workpieces on the sensor, and check the function of the buttons and sensors.
4. Create a library-capable code module in the programming language structured text (ST or SCL).
5. Create a new organisational module Main [OB1] in the programming language Structured Text (ST or SCL), access the library-capable code module there and connect these with global variables.
6. Load the complete program to the controller.
7. Test the program on the sensor station using a camera (SSC).
8. Monitor the program online and correct any errors.
9. Save and archive the project **LearningFactory_4_0_24V_Task02_SensorsSSC**.

Programming information

Information on creating library-capable programming modules:

Library-capable code modules are preferred for structured programming of PLC programs. This means that the input and output parameters of a function or function module are determined generally in local variables, and are only assigned current global variables (inputs/outputs) when using the module.

The advantage of this is that the module can be accessed multiple times.

Information on the colour sensor

The fischertechnik colour sensor emits white light, which different colour surfaces reflect to different degrees. The photo-transistor measures the intensity of the reflected light and measures read as a voltage value ranging between 0 V and 9 V on an analogue input 0-10V on the PLC. This measured value (0-9 V) is digitised into a whole number between 0 and 24883 by the analogue input assembly.

The measured value depends on the ambient brightness as well as the distance of the sensor from the coloured surface.

Therefore, the values for the 3 different workpieces in blue/white/red should be determined through multiple measurements.

This makes it possible to calculate an average value for each colour. For the analysis, you should also stipulate a tolerance range around this average value, since measurement results always involve a certain amount of inaccuracy.

Programming task 3:

Sensor station with camera (SSC), camera movement without pulse width modulation (PWM)

Task:

The camera movement should be activated via the outputs directly in the sensor station with camera (SSC), without pulse width modulation (PWM).

Press the START button to start a reference run. The camera will move horizontally and clockwise to the position of the reference switch, horizontally and vertically down to the reference position for the vertical axis.

Press the STOP button to move the camera up for 2 seconds horizontally in an anti-clockwise direction, and vertically up.

If START or STOP are pressed while the camera is moving, the direction will be reversed.

The program should be created in the programming language Structured Text (ST or SCL).

Planning

1. In the TIA Portal, open the project **LearningFactory_4_0_24V_Task01_HWConf** and save it under the name **LearningFactory_4_0_24V_Task03_CameraSSC**.
2. Copy the global variable table **SSC Camera Station**, as shown in programming task 1, from the library **Library_LearningFactory_4_0_24V** and insert it into your project.
3. Insert the jumpers to provide a power supply to the bi-directional motors, so that the motors are fed directly via the +24V actuators.
4. Add to the monitoring table as shown in programming task 1, and check the function of I/O signals.
5. Create a library-capable code module in the programming language structured text (ST or SCL).
6. Create a new organisational module Main [OB1] in the programming language Structured Text (ST or SCL), access the library-capable code module there and connect these with global variables.
7. Load the complete program to the controller.
8. Test the program on the sensor station using a camera (SSC).
9. Monitor the program online and correct any errors.
10. Save and archive the project **LearningFactory_4_0_24V_Task02_CameraSSC**.
11. Insert the jumpers for the power supply to the bi-directional motors so that they are fed via the associated PWM terminals 2 and 3.

Programming information

Information on pulse width modulation (PWM):

The bi-directional motors for the horizontal axis (turn camera) and the vertical axis (camera height) are controlled by relays and can be fed either directly via 24V of the actuators, or via the associated PWM terminals 2 and 3.

| | Sensor station with camera (SSC) |
|-------|----------------------------------|
| PWM 1 | - not assigned - |
| PWM 2 | Camera height |
| PWM 3 | Turn camera |
| PWM 4 | - not assigned - |

Assigning the PWM jumper:

The jumpers should be inserted at the right for this task for power supply via +24V (actuators).

The jumpers are on the adapter board

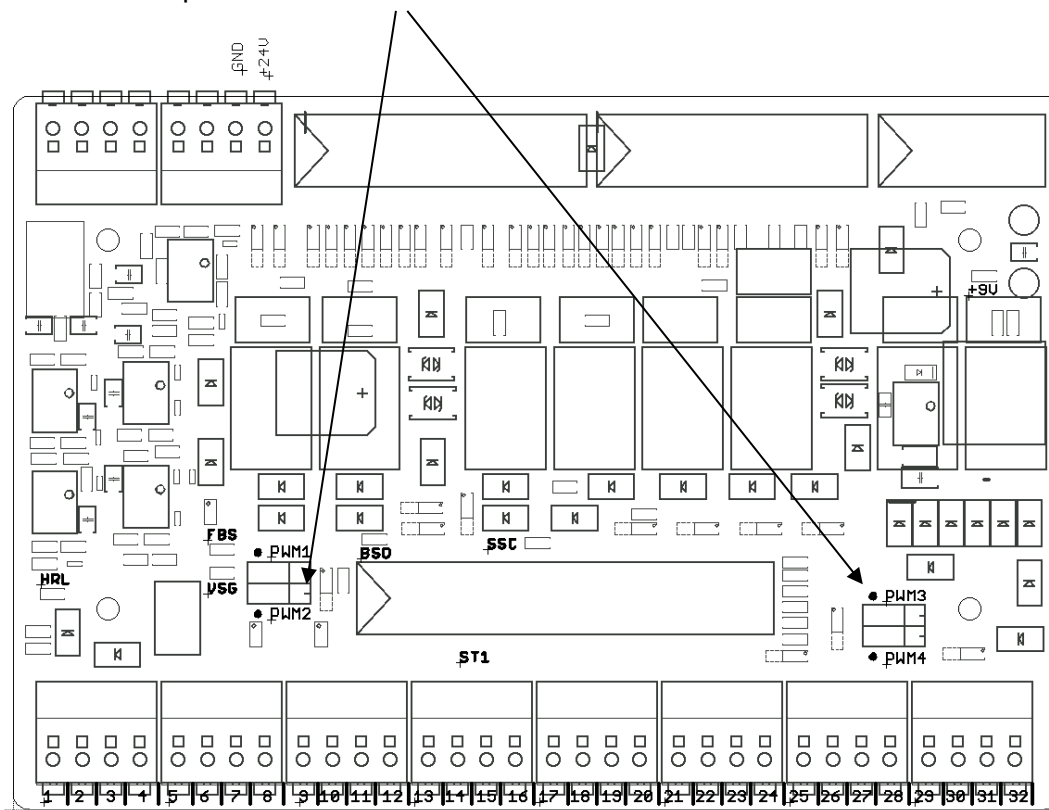

Programming information

Since the positive signal flank of the START button should be analysed in this task, and a timer is used, a function block (FB) must be programmed here as a coding module.

Programming task 4:

Sorting line with colour detection (SLD); sequence with simple positioning function without colour detection

Task:

Workpieces should be transported in the sorting line with colour detection (SLD) from the start of the belt to the second storage location, regardless of their colour.

If there is a workpiece on the belt at the entrance to the light barrier, and if the second storage location is free, press the START button to switch on the belt. The pulse button counts the pulses from the light barrier to the colour sensor, in order to detect position. The belt should be stopped once the workpiece is in front of the second extension cylinder.

There, the workpiece is moved to the second storage position by the second extension cylinder. The workpiece must then be removed manually there.

Press the STOP button to stop the process. Workpieces must be removed from the system before the sorting line can be started once again.

The program should be created in the programming language Structured Text (ST or SCL).

Planning

1. In the TIA Portal, open the project **LearningFactory_4_0_24V_Task01_HWConf** and save it under the name **LearningFactory_4_0_24V_Task04_SortingSLD**.
2. Copy the global variable table **SLD Sorting Line with Detection**, as shown in programming task 1, from the library **Library_LearningFactory_4_0_24V** and insert it into your project.
3. Add to the monitoring table as shown in programming task 1, and check the function of I/O signals.
4. Create a library-capable code module with the sequence in the programming language structured text (ST or SCL).
5. Create a new organisational module Main [OB1] in the programming language Structured Text (ST or SCL), access the library-capable code module there and connect these with global variables.
6. Load the complete program to the controller.
7. Test the program on the sorting line with colour detection (SLD).
8. Monitor the program online and correct any errors.
9. Save and archive the project **LearningFactory_4_0_24V_Task04_SortingSLD**.

Programming information

Information on programming sequences in the programming language structured text (ST or SCL).

In addition to other options for programming a process control or a sequence in the programming language Structured Text (ST or SCL), the control or sequence can be programmed, for instance, in a case instruction. The number of the step that is currently being completed is always in the statistical variable #Step_number. Only the commands programmed for the relevant step number are executed. The system transitions to the next step by incrementing the variable #Step_number in the step by +1. The variable #Step_number is set to 0 to transition from the last step to step 0 and reset the sequence.

```
□ CASE #Step_number OF
  0: // Initial step
    ;
  1: // Step 1
    ;
  2: // Step 2
    ;

  //....
  ELSE // Statement section ELSE
    ;
END_CASE;
```

Since statistical variables are also required in the sequence, a function block (FB) must be programmed here as a code module.

Information on positioning

Since the conveyor belt does not move very quickly, and since the position in front of the extension cylinder does not have to be very exact, it is enough to detect signals from the pulse sensor in the normal cyclical organisational block OB1 for this simple positioning function.

A simple counter can be used to count the pulses in the program. The value can then be compared.

You can determine the number of required pulses by activating the conveyor belt motor and observing the counter value.

Programming task 5:

Vacuum suction gripper (VGR); sequence with pulse width modulation (PWM) and simple positioning function

Task:

The vacuum suction gripper station (VGR) should be used to transport workpieces independent of their colour from the material storage to the material scrap area.

The motors for gripper movements are controlled via a relay and supplied with power via the associated PWM terminals. The motor speed can be set using the output signals from pulse width modulation (PWM). The speed should be set fairly low in this task, so that positioning is simpler.

Press the START button to start the process. First, the suction gripper moves back horizontally to the reference switch, then up vertically, and finally in a clockwise direction to the reference position at the material storage.

Then, it positions the vacuum down vertically to the pick-up position at the material storage, then switches the vacuum on and moves back up to the reference switch.

Now the suction gripper turns anti-clockwise to set down material scrap, then vertically down to the discharge position, where it switches the vacuum off again.

Press the STOP button to stop the process.

The program should be created in the programming language Structured Text (ST or SCL).

Planning

1. In the TIA Portal, open the project **LearningFactory_4_0_24V_Task01_HWConf** and save it under the name **LearningFactory_4_0_24V_Task05_VacuumGripperVGR**.
2. Copy the global variable table **VGR Vacuum Gripper Robot**, as shown in programming task 1, from the library **Library_LearningFactory_4_0_24V** and insert it into your project.
3. Check whether the jumpers for the power supply to the bi-directional motors are inserted so that they are fed via the associated PWM terminals 1, 2 and 3.
4. Add to the monitoring table as shown in programming task 1, and check the function of I/O signals.
5. Create a library-capable code module with the sequence in the programming language structured text (ST or SCL).
6. Create a new organisational module Main [OB1] in the programming language Structured Text (ST or SCL), access the library-capable code module there and connect these with global variables.
7. Load the complete program to the controller.
8. Test the program using the vacuum suction gripper (VGR).
9. Monitor the program online and correct any errors.
10. Save and archive the project **LearningFactory_4_0_24V_Task05_VacuumGripperVGR**.

Programming information

Information on pulse width modulation (PWM):

The bi-directional motors for turning, for the horizontal axis and the vertical axis are controlled by relays and can be fed either directly via 24V of the actuators, or via the associated PWM terminals 1, 2 and 3.

| | Vacuum suction gripper (VGR) |
|-------|------------------------------|
| PWM 1 | Y(Vertical) |
| PWM 2 | Z(Horizontal) |
| PWM 3 | X(Turn) |
| PWM 4 | |

Assigning the PWM jumper:

The jumpers should be inserted on the left for PWM for this task. The motors are controlled via a relay and supplied with power via the associated PWM terminals.

The jumpers are on the adapter board

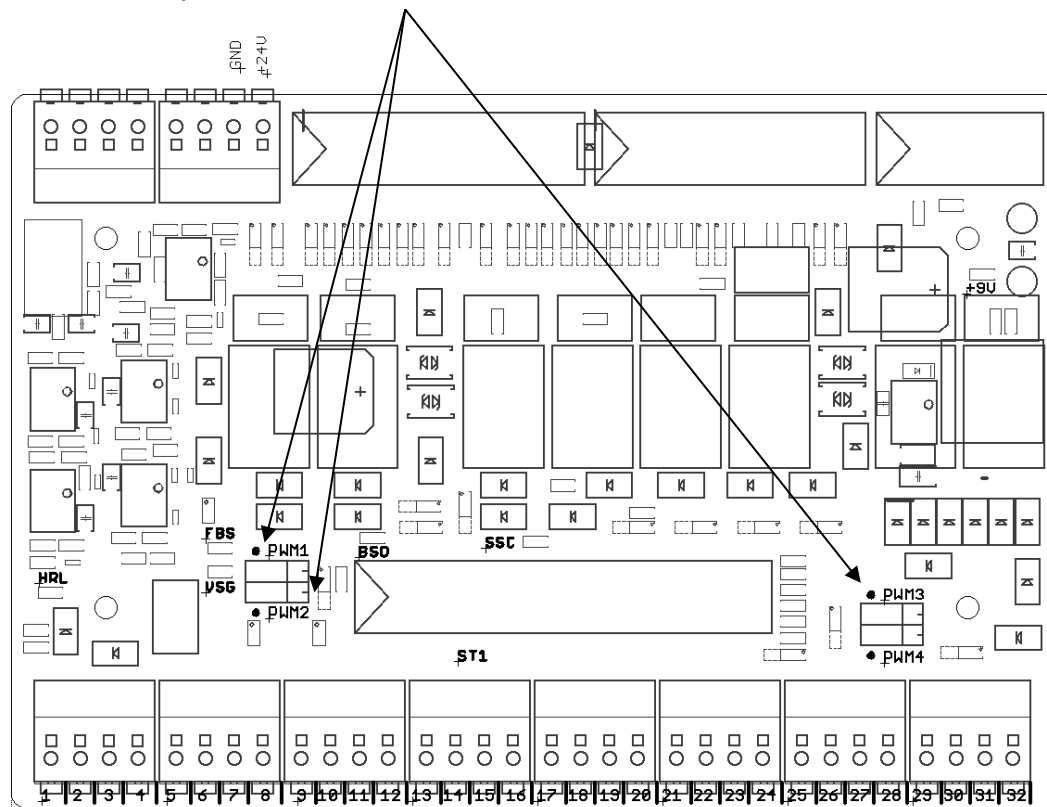

You can specify whole numbers (integer format) on the outputs for the PWM signals in the PLC program, and thereby control the speed. A low speed should be specified here for all axes with a value of 400.

Information on positioning

Due to the low speed of the 3 axes, it is enough to detect pulse 1 from the respective encoder in the normal cyclical organisational block OB1 for positioning.

A simple counter can be used to count the pulses in the program. The value can then be compared.

You can determine the number of pulses for the required positions by activating the individual axes and observing the counter value.

Programming task 6:

Multi-processing station with oven (MPO); sequence with pulse width modulation (PWM) and parallel actions

Task:

In the multi-processing station with oven (MPO), workpieces should undergo a burning process before they are sawed and then transported to the next station.

The motors for vacuum suction and turntable movements are controlled via a relay and supplied with power via the associated PWM terminals. The motor speed can be set using the output signals from pulse width modulation (PWM).

First, a workpiece must be placed manually on the turntable.

Press the START button to start the process for a workpiece.

At the same time, the oven will open, the turntable will turn to the position at the vacuum, and the vacuum will move to the turntable.

Then the vacuum will move down, switch on and lift the workpiece from the turntable.

While the linear axis moves to the oven, the extension there is extended.

Once it has arrived at the oven, the vacuum gripper will place the workpiece on the extension. The extension will retract, the oven door will close and the burning process will be carried out for 5 seconds.

Then the oven door will open again, the extension will be extended, and the vacuum gripper will pick up the workpiece once again to move it back to the turntable.

The turntable will then position the workpiece under the saw. The saw will process it for 5 seconds.

Then the workpiece will be turned into position on the belt and pushed to the extension cylinder on the belt there.

The conveyor belt will transport the workpiece to the light barrier at the end of the belt, where it can be removed manually.

The program should be created in the programming language Structured Text (ST or SCL).

To shorten the time for a production cycle, complete multiple actions at the same time in a single step if possible.

The signals for pulse width modulation (PWM) and for the compressor should not be specified in the steps of the sequence, but rather in subsequent ongoing operation.

Planning

1. In the TIA Portal, open the project **LearningFactory_4_0_24V_Task01_HWConf** and save it under the name **LearningFactory_4_0_24V_Task06_MultiProcessingMPO**.
2. Copy the global variable table **MPO-Multi-Processing station with oven**, as shown in programming task 1, from the library **Library_LearningFactory_4_0_24V** and insert it into your project.
3. Check whether the jumpers for the power supply to the bi-directional motors are inserted so that they are fed via the associated PWM terminals 1 and 3.
4. Add to the monitoring table as shown in programming task 1, and check the function of I/O signals.
5. Create a library-capable code module with the sequence in the programming language structured text (ST or SCL).
6. Create a new organisational module Main [OB1] in the programming language Structured Text (ST or SCL), access the library-capable code module there and connect these with global variables.
7. Load the complete program to the controller.
8. Test the program using the vacuum suction gripper (VGR).
9. Monitor the program online and correct any errors.
10. Save and archive the project **LearningFactory_4_0_24V_Task06_MultiProcessingMPO**.

Programming information

Information on pulse width modulation (PWM):

The bi-directional motors for the turntable and for horizontal movement of the vacuum on the linear axis are controlled by relays and can be fed either directly via 24V of the actuators, or via the associated PWM terminals 1 and 3.

| | Multi-processing station (MPO) |
|-------|--------------------------------|
| PWM 1 | Turntable |
| PWM 2 | - not assigned - |
| PWM 3 | Suction (Horizontal) |
| PWM 4 | Oven pusher |

Assigning the PWM jumper:

The jumpers should be inserted on the left for PWM for this task. The motors are controlled via a relay and supplied with power via the associated PWM terminals.

The jumpers are on the adapter board

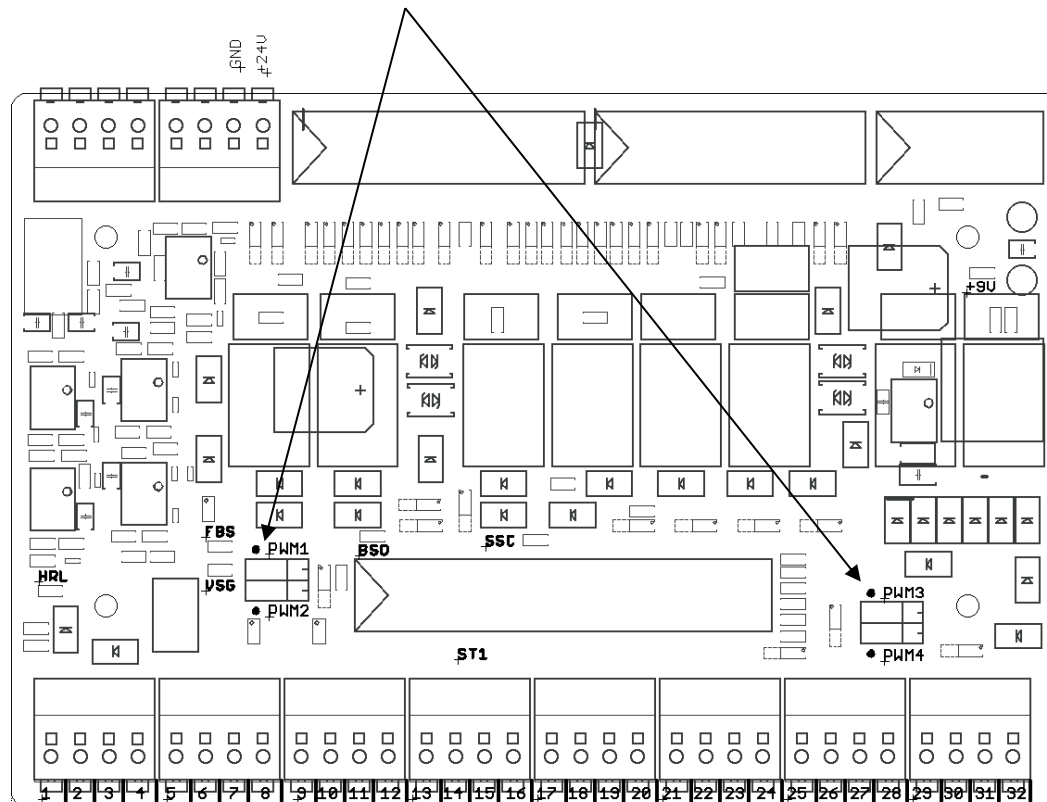

You can specify whole numbers (integer format) on the outputs for the PWM signals in the PLC program, and thereby control the speed.

Programming task 7:

Automated high-bay warehouse (HBW); sequence with pulse width modulation (PWM) and positioning function with encoder

Task:

The automated high-bay warehouse (HBW) station is designed to move a pallet from the top front position (position A1) and set it on the conveyor belt.

The motors for stacker crane movements are controlled via a relay and supplied with power via the associated PWM terminals. The motor speed can be set using the output signals from pulse width modulation (PWM). The encoder should be used to precisely position the axes.

Press the START button to start the process. First, the stacker crane moves the cantilever to the rear, then at the same time to the reference switch horizontally and forward out of the storage area, as well as upward vertically. In this reference position, positioning values are set to a reference value of 0.

Then the stacker crane moves to the front top position (position A1) to extend. There, the cantilever is extended to move the vertical axis up briefly to lift the pallet. The cantilever will then move back.

Then the stacker crane will move to the discharge position on the conveyor belt. There, the cantilever is extended once again to move the vertical axis down briefly to set down the pallet.

The cantilever then moves back, while the conveyor belt transports the pallet to the light barrier at the outside end of the belt. The pallet must be removed manually before the process can be started once again.

Press the STOP button to stop the process.

The program should be created in the programming language Structured Text (ST or SCL).

To shorten the time for a production cycle, complete multiple actions at the same time in a single step if possible. The signals for pulse width modulation (PWM) should not be specified in the steps of the sequence, but rather in subsequent ongoing operation.

Planning

1. In the TIA Portal, open the project **LearningFactory_4_0_24V_Task01_HWConf** and save it under the name **LearningFactory_4_0_24V_Task07_HighBayWarehouseHBW**.
2. Copy the global variable table **HBW automated high-bay warehouse**, as shown in programming task 1, from the library **Library_LearningFactory_4_0_24V** and insert it into your project.
3. Under programming modules, create a **Positioning** group and insert a wake alarm OB **Cyclic Interrupt [OB30]** there according to the programming information with a cycle of 1000 μ s. Read in the Encoder inputs in the sub-process screen for this wake alarm OB.
4. Copy the library module **FB_INC_DEC** for encoder evaluation from the library **Library_LearningFactory_4.0_24V** and insert it into your project in the **Positioning** group.
5. Create a global data block **Positioning [DB90]** in the **Positioning** group with a global variable for position (INT) and direction (BOOL) for the horizontal and vertical axis.
6. Access and activate the module **FB_INC_DEC** for encoder evaluation in the wake alarm OB **Cyclic Interrupt [OB30]** for both the horizontal and vertical axes.
7. Check whether the jumpers for the power supply to the bi-directional motors are inserted so that they are fed via the associated PWM terminals 1, 2.3 and 4.
8. As shown in programming task 1, add all input/output signals and the values from the global data block **Positioning [DB90]** to the observation tables. Check the functions of the I/O signals and encoder analysis with the help of the observation table, and determine position values for the positions required in the program.
9. Create a library-capable code module with the sequence in the programming language structured text (ST or SCL).
10. Create a new organisational module Main [OB1] in the programming language Structured Text (ST or SCL), access the library-capable code module there and connect these with global variables.
11. Load the complete program to the controller.
12. Test the program using the automated high-bay warehouse (HBW).
13. Monitor the program online and correct any errors.
14. Save and archive the project **LearningFactory_4_0_24V_Task07_HighBayWarehouseHBW**.

Programming information

Information on pulse width modulation (PWM):

The bi-directional motors for the cantilever, for the conveyor belt, for the horizontal axis and the vertical axis are controlled by relays and can be fed either directly via 24V of the actuators, or via the associated PWM terminals 1, 2.3 and 4.

| | High-bay warehouse (HBW) |
|-------|--------------------------|
| PWM 1 | Conveyor belt |
| PWM 2 | X(Horizontal) |
| PWM 3 | Y(Vertical) |
| PWM 4 | Cantilever |

Assigning the PWM jumper:

The jumpers should be inserted on the left for PWM for this task. The motors are controlled via a relay and supplied with power via the associated PWM terminals.

The jumpers are on the adapter board

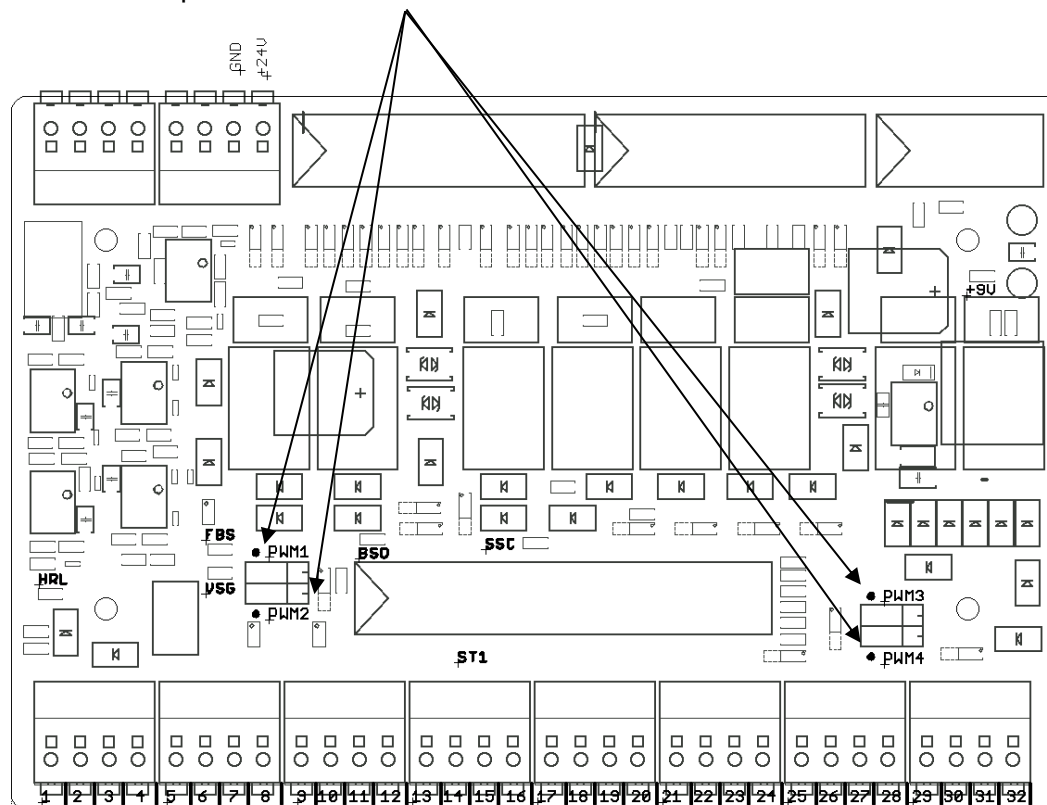

You can specify whole numbers (integer format) on the outputs for the PWM signals in the PLC program, and thereby control the speed.

Information on creating a wake alarm OB and reading in the encoder inputs

Wake alarm OBs can be used to start program components at equidistant time intervals and read in inputs accordingly. Create a wake alarm OB with a 1ms cycle time as follows:

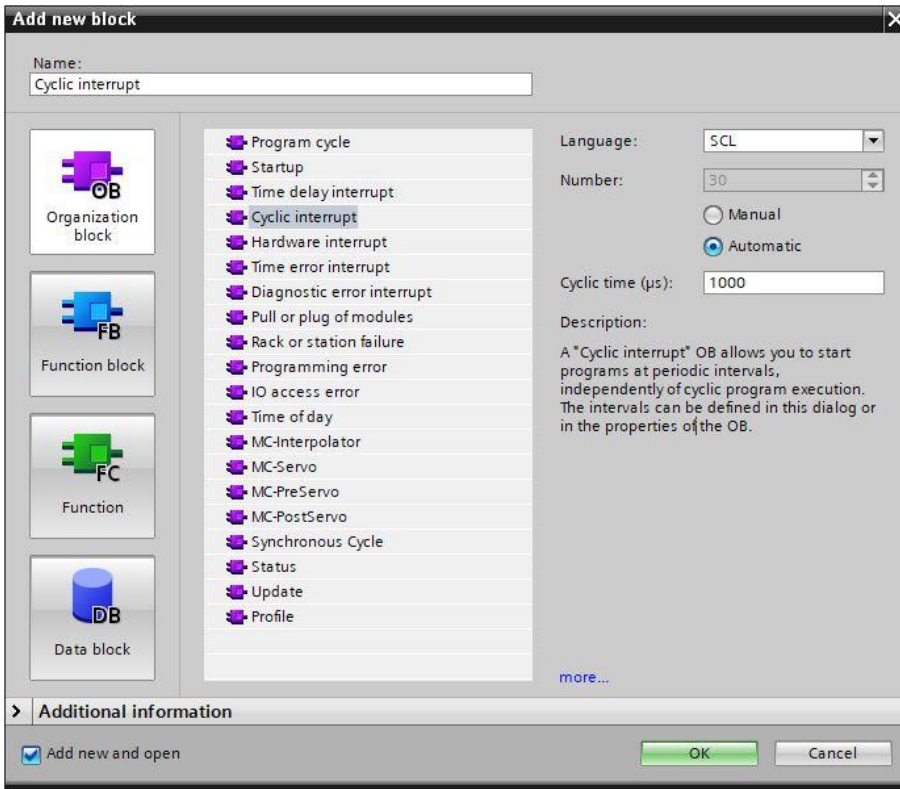

The settings must be changed so that inputs in the sub-process screen (TPA 1) for this wake alarm OB must be read in for the assemblies for encoder inputs.

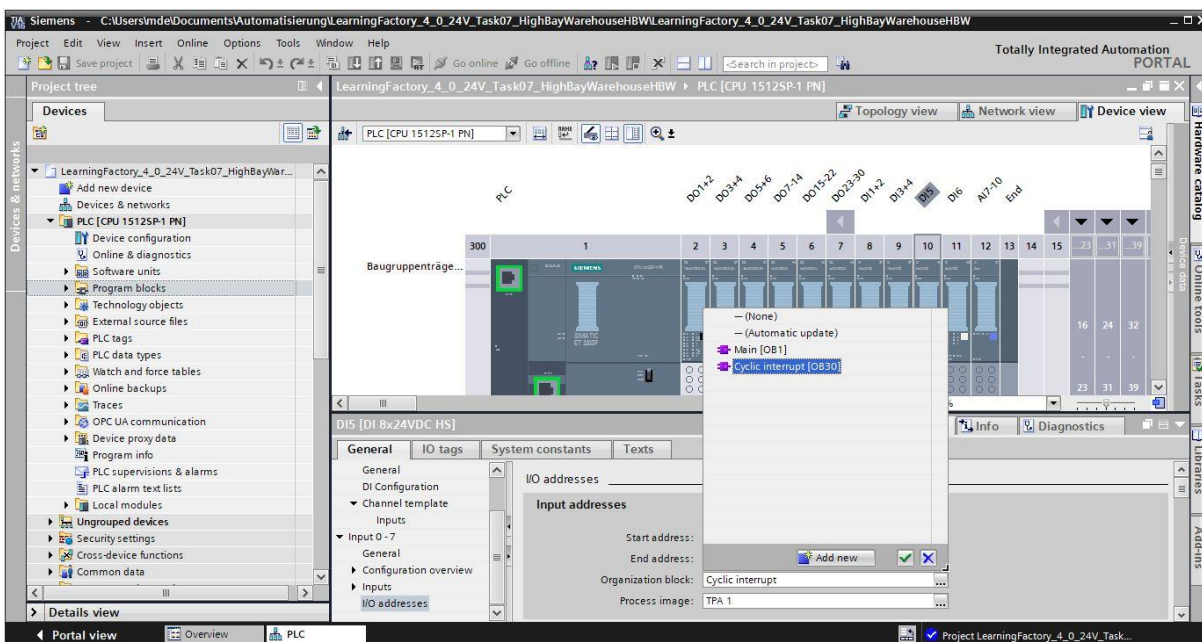

Information on positioning with the encoder and fischertechnik library module FB_INC_DEC

In this programming task, tracks A+B and pulses 1 and 2 for the encoders must be recorded for the horizontal and vertical axes in a wake alarm organizational module with a cycle time of 1ms, in order to ensure precise positioning even with high speed movements.

A module **FB_INC_DEC** has already been provided in the available library **Library_LearningFactory_4_0_24V** for encoder evaluation. It can simply be copied from there into the project.

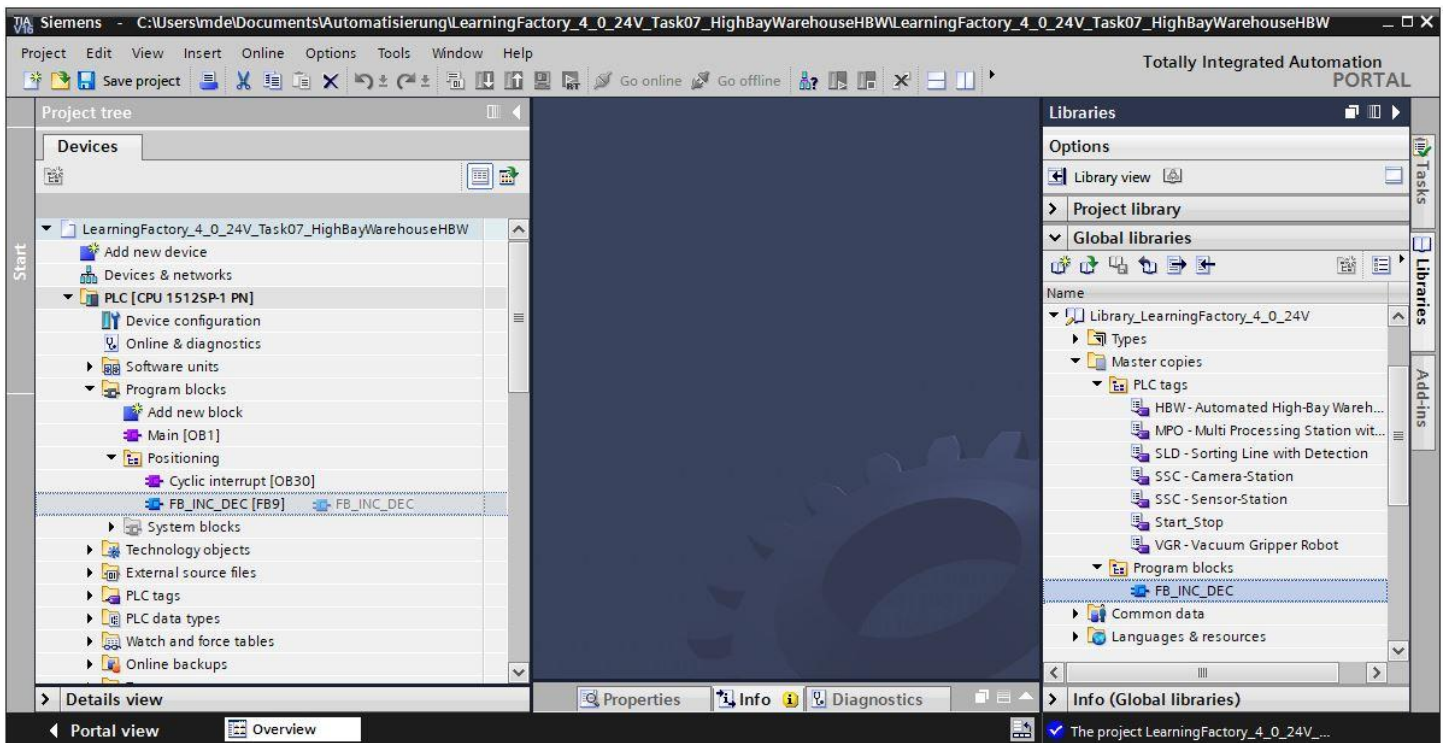

The module **FB_INC_DEC** for encoder evaluation assesses the pulses for the two channels at the inputs **#inx_CHa** and **#inx_CHb**.

This is used to determine the direction **#outx_dir** and a position value **#outi_cnt** and provide these as outputs. The input **#inx_RST** can be used to reset the position value to a reference value **#ini_REF_val**.

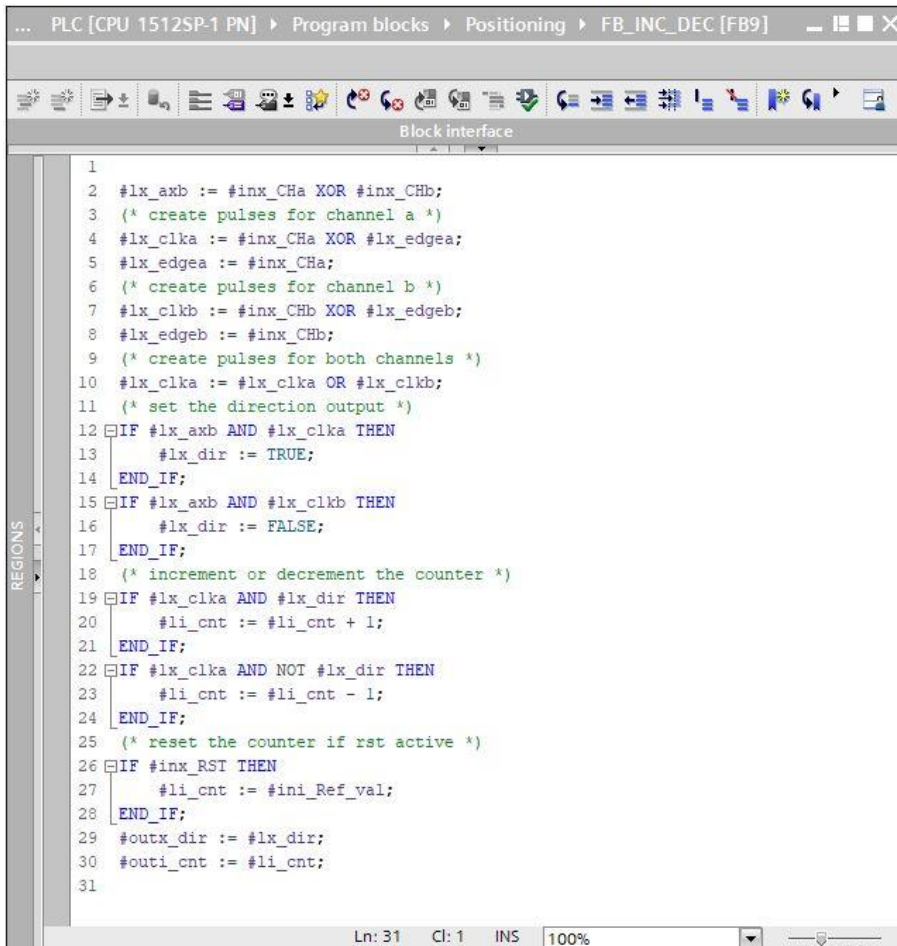

```

1
2 #lx_axb := #inx_CHa XOR #inx_CHb;
3 (* create pulses for channel a *)
4 #lx_clka := #inx_CHa XOR #lx_edgca;
5 #lx_edgca := #inx_CHa;
6 (* create pulses for channel b *)
7 #lx_clkb := #inx_CHb XOR #lx_edgcb;
8 #lx_edgcb := #inx_CHb;
9 (* create pulses for both channels *)
10 #lx_clka := #lx_clka OR #lx_clkb;
11 (* set the direction output *)
12 IF #lx_axb AND #lx_clka THEN
13     #lx_dir := TRUE;
14 END_IF;
15 IF #lx_axb AND #lx_clkb THEN
16     #lx_dir := FALSE;
17 END_IF;
18 (* increment or decrement the counter *)
19 IF #lx_clka AND #lx_dir THEN
20     #li_cnt := #li_cnt + 1;
21 END_IF;
22 IF #lx_clka AND NOT #lx_dir THEN
23     #li_cnt := #li_cnt - 1;
24 END_IF;
25 (* reset the counter if rst active *)
26 IF #inx_RST THEN
27     #li_cnt := #ini_Ref_val;
28 END_IF;
29 #outx_dir := #lx_dir;
30 #outi_cnt := #li_cnt;
31
Ln: 31 Cl: 1 INS 100%
    
```

The module **FB_INC_DEC** for encoder evaluation should be accessed and activated in a wake alarm OB for both the horizontal and vertical axes.

```

"FB_INC_DEC_DB"(inx_CHa:=false,
                inx_CHb:=false,
                inx_RST:=False,
                ini_Ref_val:=0,
                outx_dir=>_bool_out_,
                outi_cnt=>_int_out_);
    
```

The position values can be determined for the positions required in the program by activating the individual axes and monitoring the position values in the observation table. The reference position in each case is 0.

1. 2020 edition

fischertechnik GmbH
Klaus-Fischer-Straße 1
72178 Waldachtal

Ph: (+49) 7443 12 - 4369
E-Mail: info@fischertechnik.de