

elneos[®] connect

the lifetime experience



The new workplace and furniture system by *erfi*.



elneos[®] connect

the lifetime experience

The new workplace and furniture system by *erfi*.



elneos[®] connect

the lifetime experience

List of Contents	Page
The workplace system <i>elneos connect</i>	5-17
System explanations	18-53
The Connector	18-23
The aluminium profiles	24-25
The L-Profile	26-27
The Expand profile 1	28-29
The Expand profile 2	30-33
The erfi bridge	34-35
The height adjustment	36-37
The table frame	38-39
The technical edge alu-line	40-41
The worktop ergo-line	42-43
The 19" device cockpit.....	44-47
The lighting	48-51
Drawer unit programme	52-53

List of Contents	Page
Ordering information	54-87
Basic tables without cable flap	54
Basic tables with cable flap 180°	55
Worktops.....	55, 57
Basic tables with foldaway cable flap	56
Basic tables with retractable supply terminal....	57
L-Profile.....	58-59
Filing boards	60-61
Functional profiles for filing boards.....	62-63
LED working place lamps	64-65
RGB-LED indication lamp	66-67
19" table attachments.....	68-69
19" cockpits	70-71
Expand profile 1	72-73
Expand profile 2	74-75
erfi bridge.....	76-77
Height adjustment	78-79
Drawer unit programme	80-87
Mobile filing pedestals.....	82
Suspended drawer units.....	83
Pedestals	84
19" cabinets	85
PC cabinets, PC tray.....	85
Organising items for drawers	86-87
Index.....	88



As manufacturers and market-founders of technical working place systems in the special fields of electrotechnology and electronics, the company *erfi* developed already in the early 50s furniture systems for electronic laboratories for the industry and education as well as for offices and communication.

Due to a an excellent in-house production depth in the new factory in Freudenstadt, we guarantee a consistent quality. On a production area of more than 8.600 sq.m. we produce on our own all electronic devices and laboratory furniture systems. Due to intensive research and development work, we are able to herewith introduce our new furniture series *elneos connect*. The new design has been distinguished by several design awards and the technical safety has been certified by GS.



reddot
design award
winner 2013



product
design award
2014 ■



German
Design Award
WINNER 2014



Focus Open 2013
Silver



elneos[®] connect

the lifetime experience

Comprehensive innovations as well as certified safety characterise the new workplace and furniture system *elneos connect*. The profile system, the specially designed frames and the working place lighting are only a few of the newly developed elements.

elneos connect ensures high flexibility due to its basic profile, the L-aluminium profile which can accept additional profiles for the most different applications. The perfected profile system allows, amongst others, the incorporation and uninterrupted guiding of the cables, the adjustment of the working height by means of a strong hydraulic height adjustment as well as the connection to an overall table bridge.

All this has been made possible by the so-called Connector. It connects the framework with the table and relieves the profiles from their mere load bearing function. The Connector allows a homogenous media guidance.

The working place lighting of *elneos connect*, the light intensity and the luminous colour of which is adaptable, is a highlight due to the RGB-LED technology and sensory colour coding. In addition, *elneos connect* can be equipped at the front with an indication lamp which indicates the condition of the table.

Simple to complex

the lifetime experience



Basic table *elneos connect*

- Expand profile 1 (vertical)
- Worktop ergo-line (round corners with a radius of 20 mm)
- Integrated cable flap
- Mobile pedestal with touch-to-open technique
- Connector available in various colours





Electronic laboratory working place – filing table *elneos connect* with 3 HE aluminium channel

- Expand profile 1 (vertical)
- Worktop ergo-line (round corners with a radius of 20 mm)
- Integrated cable flap and cable tray
- 19"/3 HE aluminium channel as support for the filing board, equipped with capacitive controlled device system *elneos five*
- Filing board with aluminium functional profile Toplight
- Integrated RGB-LED lamp
- RGB indication lamp
- Mobile pedestal with touch-to-open technique





Electronic laboratory working place – cockpit table *elneos connect*

- Expand profile 1 (vertical)
- Technical edge alu-line
- Integrated cable flap and cable tray
- 19"/3HE device cockpit equipped with capacitive controlled device system *elneos five*
- Aluminium functional profile Toplight
- Integrated RGB-LED lamp
- RGB indication lamp
- Mobile pedestal with touch-to-open technique







Assembly table – filing table *elneos connect*

- Expand profile 1 (vertical)
- Motor driven height adjustment
- Technical edge alu-line
- Integrated cable flap and cable tray
- Bottom filing board with aluminium functional profile Toplight
- Integrated RGB-LED lamp
- RGB indication lamp
- Stopper edge
- Functional grooves at top and bottom
- Top filing board with aluminium functional profile Top
- Integrated stopper edge
- Functional grooves at top and bottom
- Horizontal aluminium profile with material trays
- Mobile pedestal with touch-to-open technique



Electronic laboratory working place cockpit table *elneos connect*

- erfi bridge (green), equipped with device system *acto*
- Motor driven height adjustment
- Technical edge alu-line
- Integrated cable flap and cable tray
- 19"/3 HE device cockpit equipped with capacitive controlled device system *elneos five*
- Aluminium functional profile Toplight
- Integrated RGB-LED lamp
- RGB indication lamp
- Mobile pedestal with touch-to-open technique



1) The cockpit

The device cockpit is particularly light due to the aluminium profiles at top and bottom and very flexible for the installation of systems components.

2) The lighting

The indication lamp and workplace lighting are equipped with high power LEDs. They allow an optimal illumination as well as the appropriate indication of the table condition.

3) The connector

The central design and connecting element of the furniture system and a decisive advantage for media guidance on the inner surface of the table. The connector links the table leg and the framework and is, thus, able to guide media of all kinds.

4) The new technical edge alu-line

A newly developed compact aluminium core with a rugged plastic casing permits completely new functions. Two grooves accessible from the bottom allow the perfect connection of bench vices and a collecting groove prevents that small items fall down.

Flexible and safe

the lifetime experience



reddot
design award
winner 2013



product
design award
2014



German
Design Award
WINNER 2014



Focus Open 2013
Silver



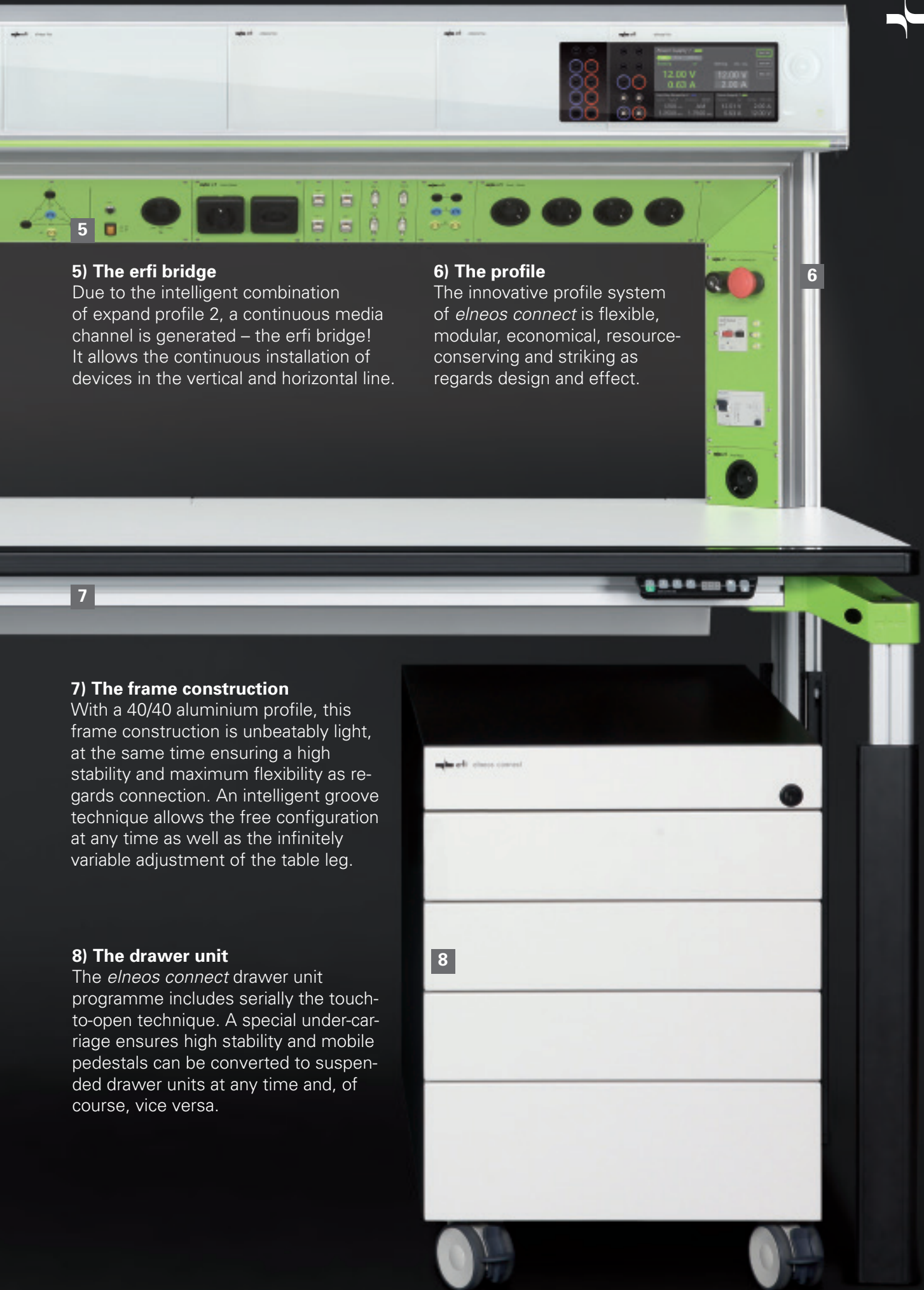

5

5) The erfi bridge

Due to the intelligent combination of expand profile 2, a continuous media channel is generated – the erfi bridge! It allows the continuous installation of devices in the vertical and horizontal line.

6) The profile

The innovative profile system of *elneos connect* is flexible, modular, economical, resource-conserving and striking as regards design and effect.

6

7

7) The frame construction

With a 40/40 aluminium profile, this frame construction is unbeatably light, at the same time ensuring a high stability and maximum flexibility as regards connection. An intelligent groove technique allows the free configuration at any time as well as the infinitely variable adjustment of the table leg.

8) The drawer unit

The *elneos connect* drawer unit programme includes serially the touch-to-open technique. A special under-carriage ensures high stability and mobile pedestals can be converted to suspended drawer units at any time and, of course, vice versa.

8



Intelligent and unrivalled

the lifetime experience

The connector

As central and functional element between table leg and frame, the connector includes the front table leg and at the same height the L-aluminium profile at the rear table leg. Through these profiles, media of any kind can be guided between table frame and table leg!

The connector

Continuous media guidance on the inner surface of the table

The connector is the centrepiece of the furniture system *elneos connect* and ensures the uninterrupted media guidance between table leg and table frame from the floor up to all system components. Media of all kinds can be passed through various additional profiles on the inner surface. Also clip profiles with a tilt function for opening can be guided uninterrupted and thus, ensure an unrivalled, new and innovative media guidance.

Infinitely variable depth adjustment of the table legs

In combination with the aluminium underframe, the connector ensures that all table legs can be shifted infinitely and variably in any desired depth position. This gives access to further persons at one working table.

Changeable table foot combinations

Due to the infinitely variable adjustment, the table legs can be adjusted precisely to the desired dimension. Therefore it is possible to change the 4-foot, C-foot and T-foot tables. For example, a C-foot table can easily be changed to a T-foot or a 4-foot table and vice versa.

Floating table top

Due to the upwards rolling shape of the connector, the table top with its frame seems to float above the end of the front table leg. The table edge thus set free, is of considerable advantage because this creates space for the collecting trays, cable guides and the LED front light. Due to the shape of the connector, the aluminium frame mounted underneath is put backwards and additional components do not interfere.

Individual height adaptation of the work space

The connector increases, in addition, the ergonomics because due to the infinitely variable vertical shifting of the L-profile an individual working height is possible.

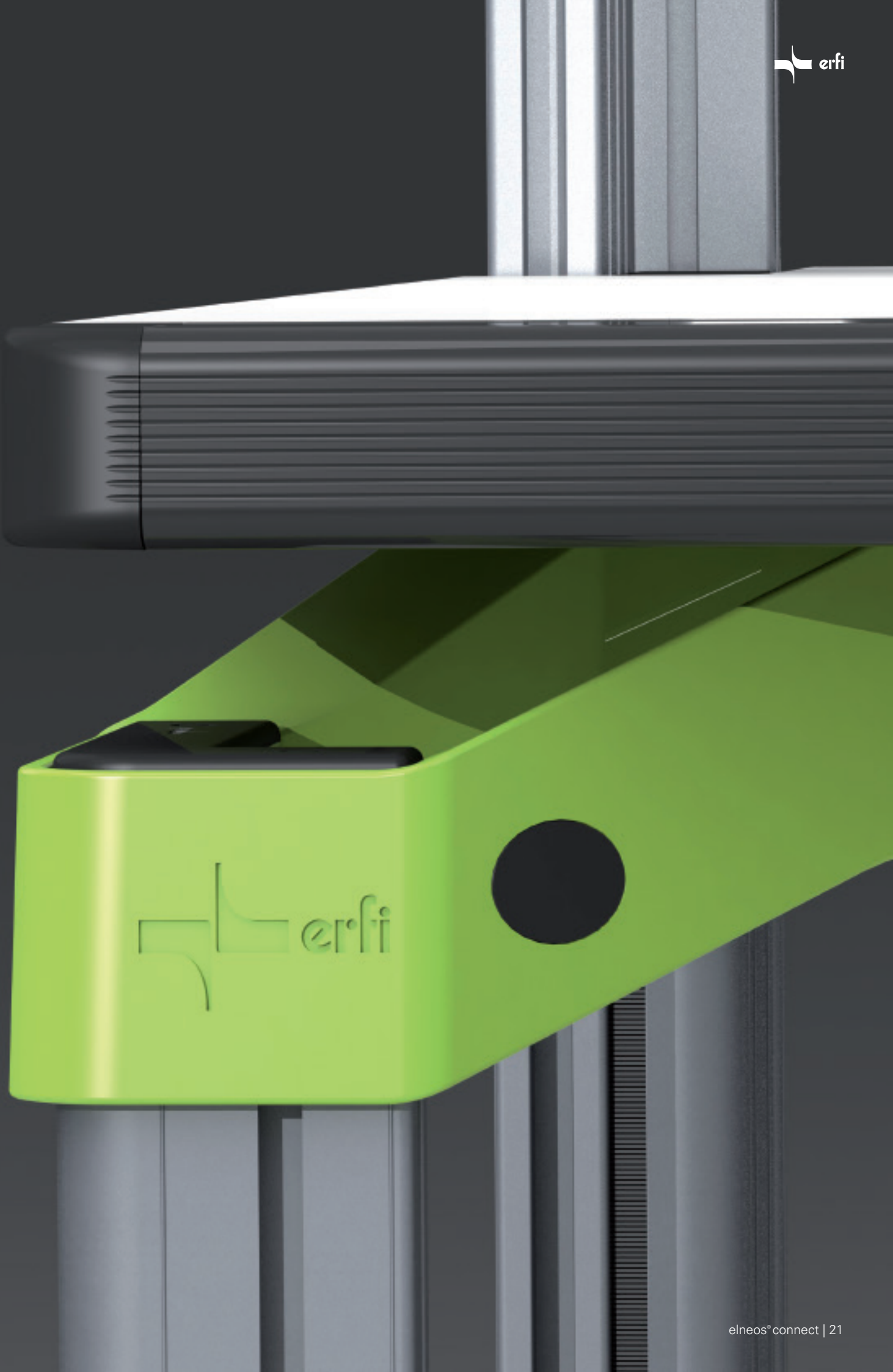

The connectors' colours

Colour surface of the connectors – the new colour code

The introduction of a new colour code within *elneos connect* is as well a new milestone. The colour code will be expressed by the connectors. The innovative connectors are serially powder-coated with a fresh and modern green, so-called *elneos green*, RAL DESIGN System (Nr. 1107070).

Holistic colour code: green – white – black – chrome

Not only the workplace system *elneos connect* radiates freshness and modernism by using the green. Also the new device system *elneos five* is convincing with its consequent and consecutive ergonomic design in many areas, where it is using *elneos green*. The colours of RAL DESIGN system achieve the requirements of *elneos connect* and *elneos five*.

The modern colouring and the detailed matching between workplace and device system played an extraordinary important role during the development. Due to the simultaneous development of both systems a colour coding could be defined the first time perfectly. Thereby *elneos connect* and *elneos five* create an entity homogeneously. The modern colour surface adds to each interior an individual character, without being intrusive. The anodized aluminium extruded leg profiles of *elneos connect* complement a noble character to the complete system.

The alternative colours pure white (RAL Nr. 9010) and graphite black (RAL Nr. 9011) can also be found in the device system, and with these colours the entity is created in the same way. At the office business area, a noble high glossy chrome finish is available. If desired, your corporate colours can be realized certainly as well.



*Standard colour elneos green
(RAL DESIGN 1107070),
Reference No. ELCC1*



*Alternative colour pure white
(RAL 9010), Reference No. ELCC2*



*Alternative colour graphite black
(RAL 9011), Reference No. ELCC3*



*Alternative colour glossy chrome,
Reference No. ELCC4*

Lightweight and functional

the lifetime experience

The profile

The furniture series *elneos connect* with their sophisticated profile system made of aluminium offer a completely new scope of combinations. The basis of this profile system is the L-profile. This basic profile is completed by additional profile forms, the expand profiles and the telescopic profile and gives *elneos connect* entire flexibility and latitude.

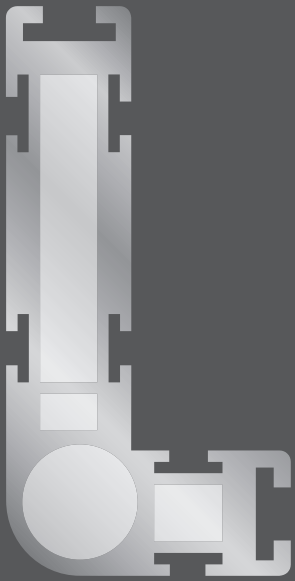

L-Profile

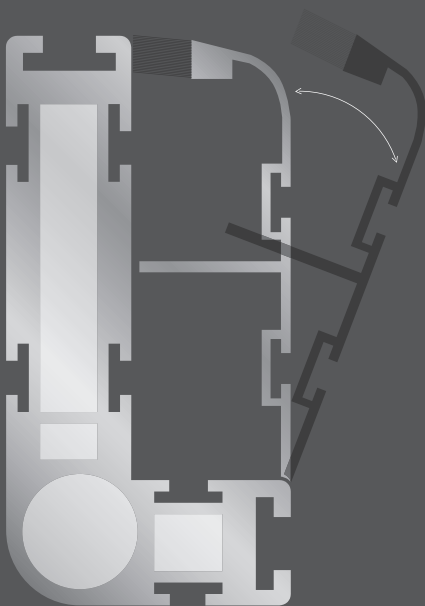

L-Profile with Expand profile 1

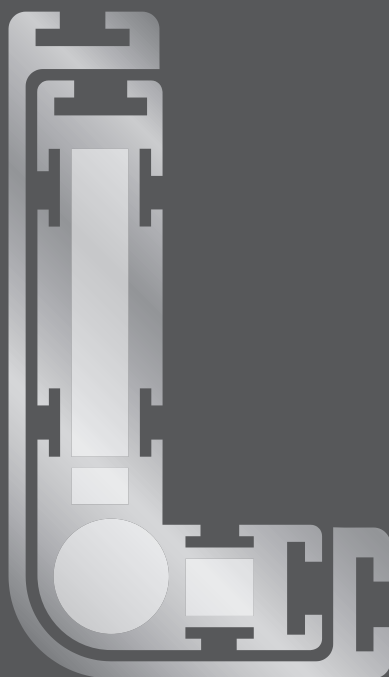

L-Profile with Telescope profile

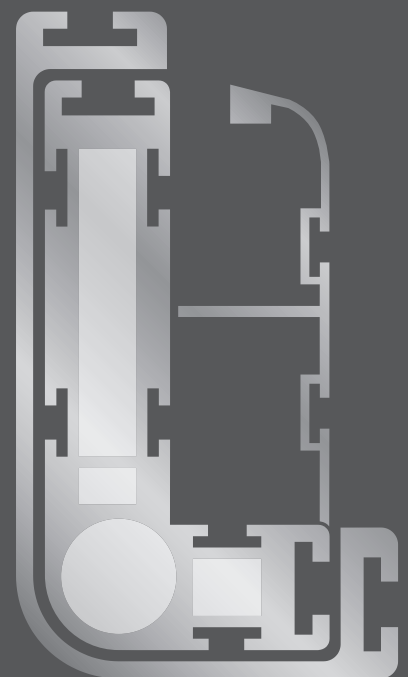

L-Profile with Expand profile 1 and Telescope profile

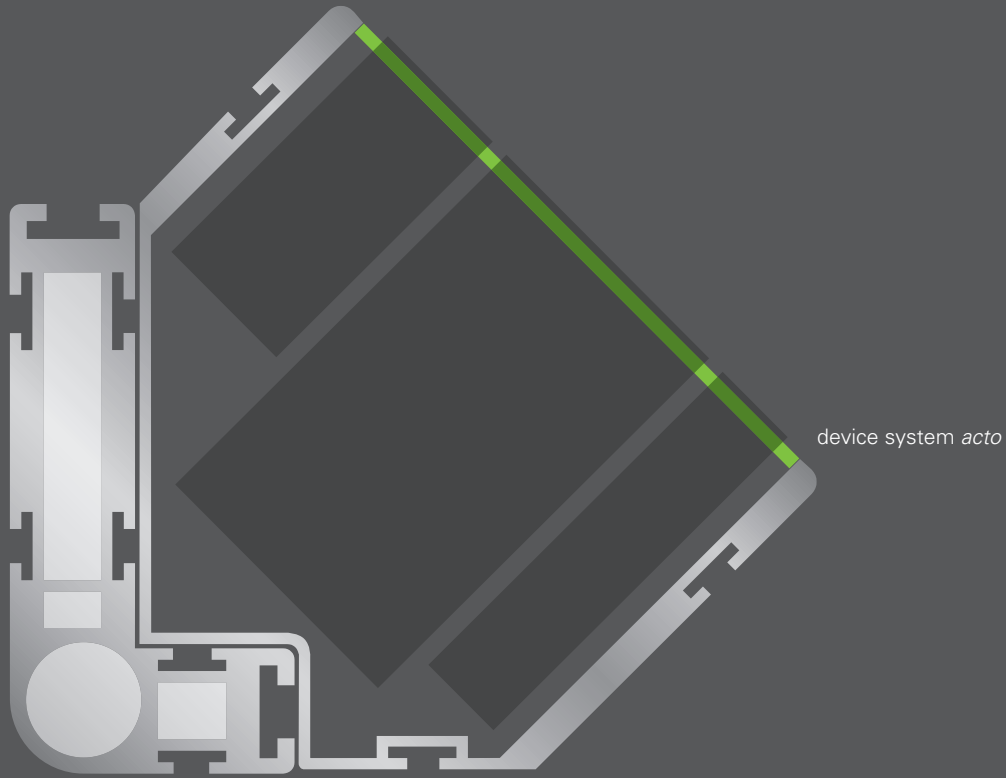

L-Profile with Expand profile 2,
front cover and device system *acto*

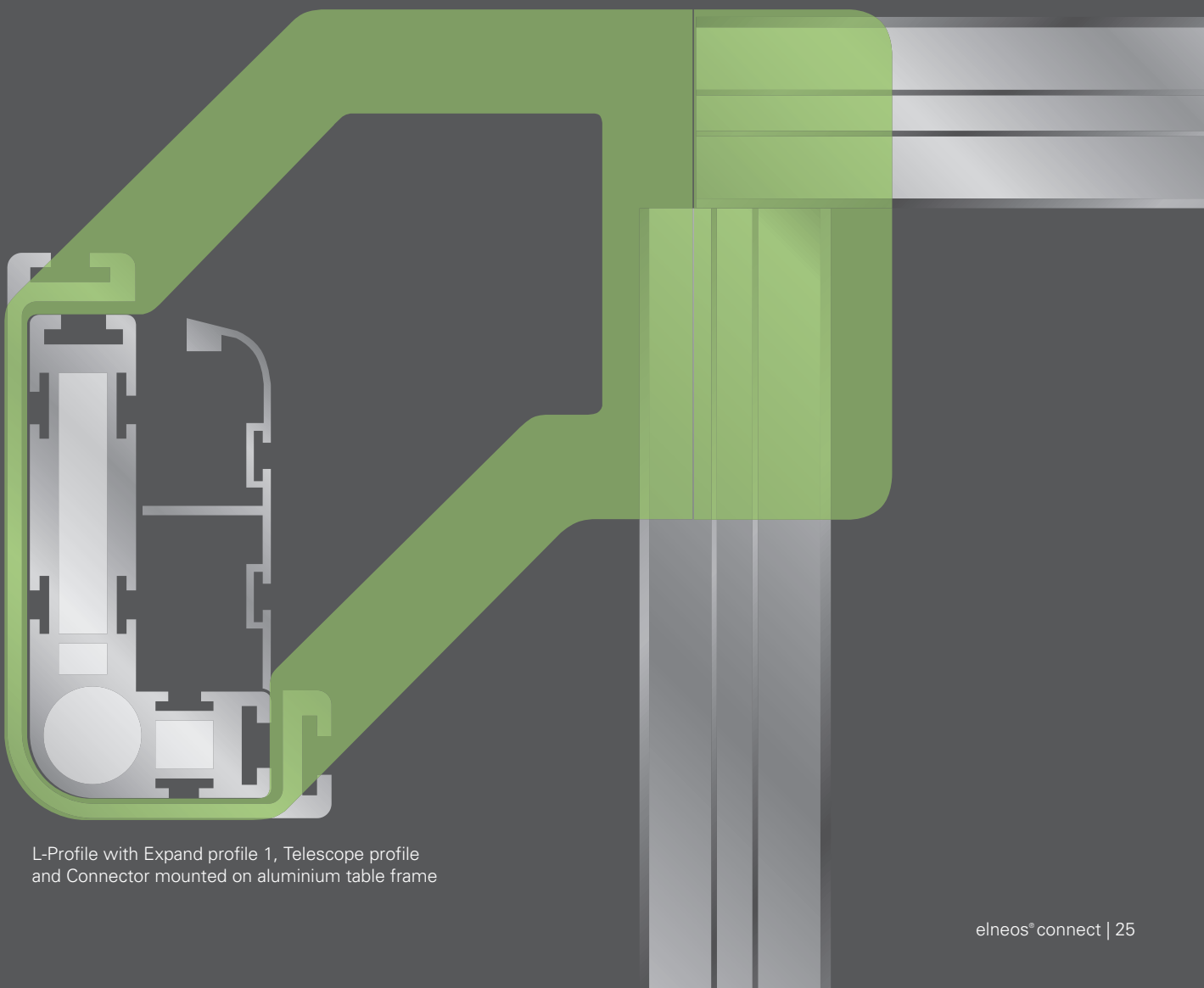

L-Profile with Expand profile 1, Telescope profile
and Connector mounted on aluminium table frame

The L-profile

The basis of the entire profile system is an aluminium profile foot, designed as L-shape. Due to the shape of this profile, there are two side pieces which in turn can accept different profiles. All so-called expand profiles and the telescopic profile are provided for the precise installation to the inner and outer surface of the L-profile and thus, the profile system allows numerous extensions.

Long side piece

The long side piece is equipped with two cable chambers and through both of them, data and power lines as well as compressed air lines can be passed. A round-shaped chamber serves in addition for housing hydraulic cylinders for the height-adjustable table. Furthermore, the long side piece can accept a foot height adjuster to compensate floor unevenness and has an additional hollow space for housing the pins for profile extension.

The side piece is provided with five T-grooves, one of them being on the front surface of the L-profile. Two grooves are on the outer and inner surface of the profile and allow the connection of additional profile system components. A clip groove on the inner surface helps to click into place a swivelling aluminium channel. This aluminium channel is shaped so that it is flush with the complete shape of the L.

Short side piece

The short side piece has a T-groove at all three open sides and due to the inside hollow space, a pin for profile extension can be fitted.

The expand profile 1

One of the many possible complements to the L-profile with *e/neos connect* is the expand profile 1. This profile is clipped to the inner surface. It is an aluminium profile to house further cables and small electric items such as data sockets or compressed air couplings. In addition, the profile has two T-grooves on the inner surface which in turn allow the integration of any system components. Multiple sockets can easily be fitted on the inner surface.

Sensible complements to the L-profile

When the expand profile and the L-profile are closed, there is now sign of the inside complexity of the complete base. The expand profile 1 can easily be opened and closed again by means of a complementary pivoted profile which acts as a hinge.

When being closed, it forms a closed space together with the L-profile and due to its structure, two additional chambers are available. The front chamber is equipped with a brush rail at the front side so that measuring cable, data lines or power lines are available to the user at the front without any crushing points.

An integrated separating strip inside the profile ensures the safe separation of the different media in the chambers.

Ingenious flexibility

1. An uninterrupted media guidance on the inner surface of the table.
2. The connector allows to swing open the expand profile.
3. The expand profile can be installed in a continuous line or separately.



The expand profile 2

Vertikal

Alternatively to expand profile 1 a larger profile can be fitted to the inner surface of the L-profile, the expand profile 2. This profile serves for integration of electronic units of a bigger installation height such as safety and switching units, sockets or generators. The profile can be fitted single-sided or double-sided to the L-profile. Due to the vertical use of the expand profile 2, partially no horizontal attachments or cockpits are needed. The profile is so big that it can even house deep components such as three-phase circuit breakers or motor protection switches.

Use in the vertical line

The profile has 6 T-grooves, two of them being directed to the outside and two of them to the inside. On the front side the profile is open and devices of the series acto can be fitted. The installation angle of 45° keeps the built-in devices in an ergonomic position for the user. On the front side there is an integrated groove for a 19" rail provided with threaded holes to which the insert plates are screwed. The inside grooves serve for fitting cap rails, sockets, plugs or electric installation material.

Three compartments in one profile

Due to the differently distributed grooves several separation planes can be fitted and thus, three separate compartments are obtained. These compartments guide media without cross-talk characteristics and without influencing the complete installation depth.

Unrivalled lateral connection of system components

The profile is technically so designed that, seen from the front, it is inclined inwardly on the outer surface. This shape leaves a free space at the outside of the profile on the level of the table top, allowing the connection of swivel arms for monitors or swivel lamps.



The expand profile 2

Vertical und Horizontal

Due to the combination of expand profile 2 in vertical and horizontal direction, a bridge can be clamped from the left to the right-hand side across the table. This bridge carries attachments such as cockpits or filing boards, admits the modular equipment of devices of the series *acto* as well as the cable and media guidance within the profile.

The intelligent slant being mounted horizontally. In horizontal condition, the profile with a slant of 45° allows the ergonomic integration of devices on the front side. Through the bevel cut a completely new coherent unit is created horizontally and vertically – the erfi bridge.

The erfi bridge

1. allows a continuous wiring
2. can be installed and retrofitted in each functional level
3. can accept components at each position
4. accepts also deep components
5. seals off inwardly electromagnetic radiation
6. can be built up as stand-alone system
7. can lead the vertical profile down to the floor
8. the colour of the front panel is freely selectable
9. bears also unsupported boards and cockpits



 erfi Safety - and Switching Unit

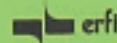

 erfi Sacknet Module





The erfi bridge

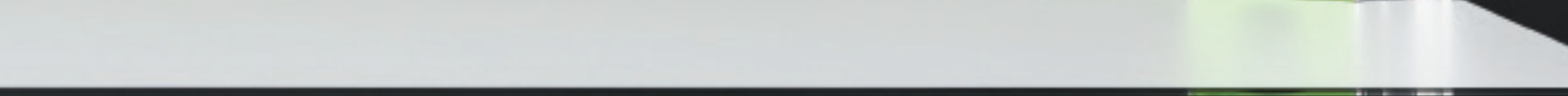
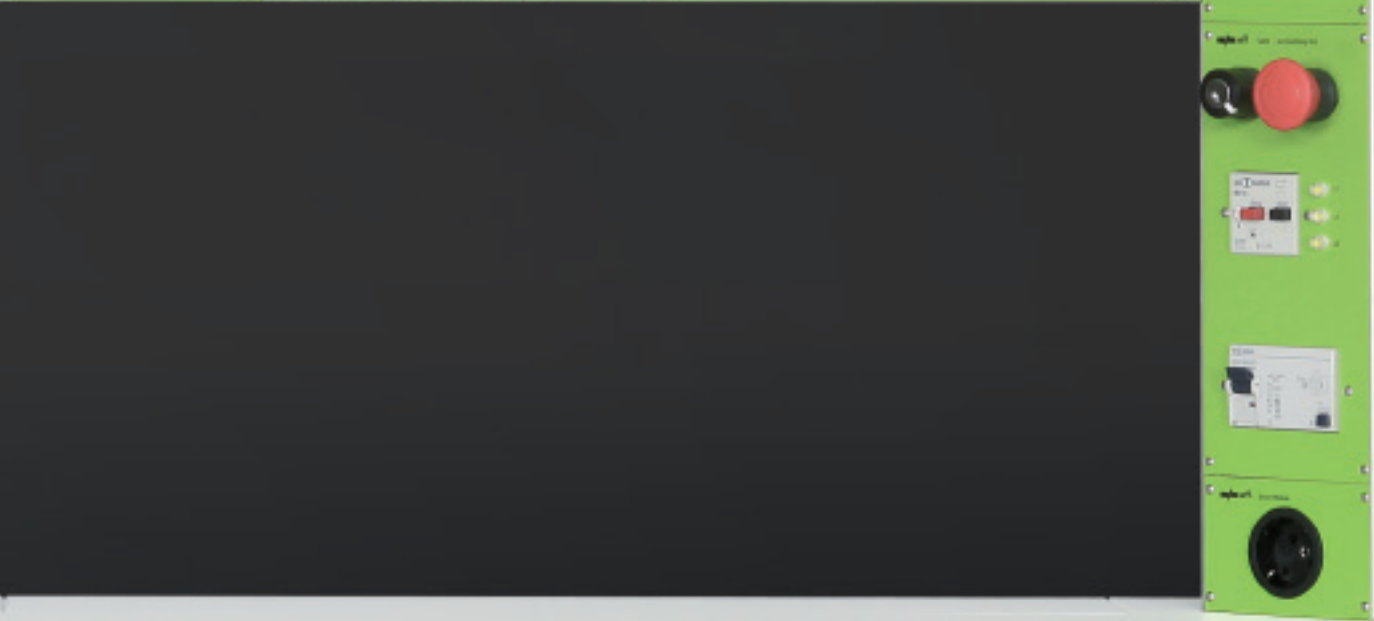



The height adjustment

Height adjustment by the telescopic profile

The new telescopic profile with functional grooves ensures very high stability. This profile is integrated when a motor driven or mechanical height adjustment is requested. In this case a hydraulic cylinder is used in each L-profile and totally four hydraulic cylinders lift the complete table construction.

The telescopic profile adapts itself to the L-profile and together with the same, it forms a rugged telescopic guiding. When the hydraulic cylinders lift, the telescopic profiles remain on the floor and the cylinders as well as the cables are invisible.

Rugged, compact height adjustment with additional function

The telescopic profile has on its front sides one T-groove each. With this, intelligent PC trays or frame reinforcements all around can be adapted which in turn increase the solidity of the table, should this be required in case of heavy loads.

High stroke lengths for high loads to be lifted

Due to the use of telescopic profiles big stroke lengths for high loads to be lifted are economically possible because the guiding is transferred from the lifting cylinder onto the telescopic leg. Thanks to our long-time experience with motor driven, height adjustable tables and our GS certified systems, we guarantee this unequalled high stability.

With table loads of up to 600 kg we realise stroke lengths of 280 mm up to 480 mm to a height of 1200 mm and this with a lifting speed of approx. 30 mm/s, with table loads of up to 220 kg and 15 mm/s and with table loads of up to 600 kg.



Lightweight, very solid

the lifetime experience

***elneos connect* = aluminium furniture**

elneos connect is the first solid aluminium furniture system in the field of electronic laboratory tables. Consistently, for almost all components and also for the frame, the modern material aluminium has been used and this makes *elneos connect* a lightweight.

Besides many additional functions, the realisation with aluminium means a weight saving of more than 30 % compared with previous systems. For companies and training centres the possibility of quickly adapting the rooms to new requirements is a decisive factor.

Perfect docking station

The functional aluminium frame is made of very solid 40 x 40 mm sized aluminium sections and has a T-groove on each side. This ensures the infinitely variable depth adjustment of the table leg and due to the lateral grooves, any additional system components can be fitted.

Suspended drawer units, PC trays or cable trays can be retrofitted in any position. The weight saving due to the aluminium frame is a decisive advantage, particularly during the erection phase or in case of relocation. In addition, the profile structure has been especially developed for heavy loads and ensures high stability!



... and changeable

Stepless adaptation

All frames can be used for the stepless adaptation of cable channels of all kinds and of drawer units. Due to the rolling shape of the connector, a free space is created between the underside of the table top and the connector which can be used for fitting holding fixtures.

The thus obtained depth variability allows a quite open legroom on the one hand and on the other hand a high flexibility of the frame for further foot positions.

Intelligent connection technology

Due to the newly developed connectors, lateral or transverse frames can be well used. The same goes for lateral frames which are easily displaceable in their position in order to obtain additional free space for cable channels or other system components. This flexibility of the *elneos connect* table is superior to any steel frame.

The new design is particularly characterized by its adaptiveness and versatility.

The technical edge alu-line

The new exposed and load-bearing technical edge alu-line is equipped with two T-grooves and a channelling function. Therefore, bench vices and other components can be fitted twist-free. The corrugation integrated in the front side protects clothes against dirt and a solid plastic covering protects the base body.

Ergonomic record performance

The newly developed cover cap has a roundness of a radius of 20 mm. All table corners are rounded and are haptically pleasant. The narrow radius of 20 mm is also ideal for table series and guarantees a longer service life of your equipment.



T-grooves and channelling function

The T-grooves integrated in the underside serve for connecting system components such as storage trays or material boxes. In addition, the edge is so designed that a bench vice can be connected twist-free without damaging the table top. The edge profile has a slight deepening on the surface to avoid that small items such as screws, tools or writing utensils fall down.

ESD design

The plastic covering of the technical edge is also available in ESD design for conductive laboratory tables. An additionally developed tool ensures perfect flow characteristics during the manufacturing process.



The worktop ergo-line

When developing the worktop ergo-line, special attention has been paid to ergonomics. The front left and right-hand corners of the working surface have been rounded and conform to the radius of the subjacent connector.

The curve is a line !

Due to the ergonomic roundness crashes are avoided and the risk of injuries is completely precluded. This is of particular importance in training centres and industrial laboratories. At the same time the worktop is especially protected against impacts at this spot due to the narrow radius.

The edge band for this worktop is mechanically applied and is in one piece! It is a thick edge of high impact resistance. Owing to specially equipped CNC mill centres with appropriate edge banding units, this special radius can be realised. The machine outfit in our factory in Freudenstadt has been extended due to this innovative edge.

Table series and individual tables

Not only for individual tables but also for table series, the narrow radius of 20 mm is ideal. The worktop cannot be attacked and a long service life of your laboratory equipment is ensured.

The new decor *front white* gives the system a noble character and elegant appearance.



The 19" device cockpit

The device cockpit of *elneos connect* is characterised by comprehensive new functions – aluminium profiles, impact barrier, T-grooves, covered cable space, swivelling and adaptive lighting which is invisible from the outside with energy-saving RGB-LED technology as well as integrated indication lamp.

elneos five, highlab and basic

The device cockpit is designed to accept the new 19" device system *elneos five*. The compactness of the new devices of *elneos five* allows clearly reduced installation heights. (260 mm) Of course, the cockpits are compatible with all 19" device systems conforming to standards. The known 19" device series *highlab* and *basic* can be fitted without difficulties next to the device series *elneos five*.

Indication lamp

The indication lamp signals the condition of your laboratory table at any time. Across the entire width of the device cockpit or the filing board, you are informed by means of a specially developed RGB light-band! In case of dangerous conditions, you can react immediately and correctly! Another milestone to optimize security at the working place.

Profiles facilitate assembly

The cockpit is equipped with aluminium functional profiles at the top and bottom of the cockpit which are now the mechanical holding fixture for the 19" insert plates. The new device system *elneos five* in particular is the perfect completion of the furniture series *elneos connect*. For installing insert boards no modifications whatsoever are required and retrofitting is possible at any time.





12.00 V
0.63 A

Function-Generator 2
Carrier Modulation
1200 mV AM
1.2500 kHz 1.7500 kHz
Power Supply
Reading
12.01
0.63

Safety - and Switching Unit

Off
On

ABL SURSUM
MS16

Stop Start

L1

L2

L3

Invisible RGB-LED swivel lamp

The bottom aluminium profile of the device cockpit holds completely the newly developed RGB swivel lamp which has RGB-LEDs as well as white LEDs. The RGB-LED lamp is swivelling, dimmable and the colour of the light is modifiable. Thus, a working atmosphere which suits your needs, can be created!

Profile elevation at the top

The top profile has a elevation on its upper surface which, for inclinable cockpits, is a protection against slipping off and protects the cockpit.

Integrated T-grooves for docking

Now it is possible to dock on the top panel of the cockpit system components due to an integrated T-groove. Thus, holding fixtures and separating plates can be horizontally adapted at any place by means of a sliding block and can be used as bookend of the like. The aluminium profile on the underside is also equipped with T-grooves for additionally possible connections of system components such as filing trays, device platforms or swivel arms.

Easy connection to neighbouring cockpits

The top profile allows the integration of comprehensive power lines, data and measuring lines. On this level, inside the profile, the cable and media guidance between two adjacent tables is possible. The wiring of cockpits side by side can be realised without difficulties through this cable space and the cables to not hinder the access to the rear side of the cockpit.



Control panel featuring a digital display and several buttons. The display shows:

- Power Supply 1
- Reading: 12.00 V, 0.63 A
- Function-Generator 2
- Center: 1200 Hz, 1.2500 kHz

The panel includes a 3x2 grid of buttons (blue and red) and two rows of four gold-colored connectors.

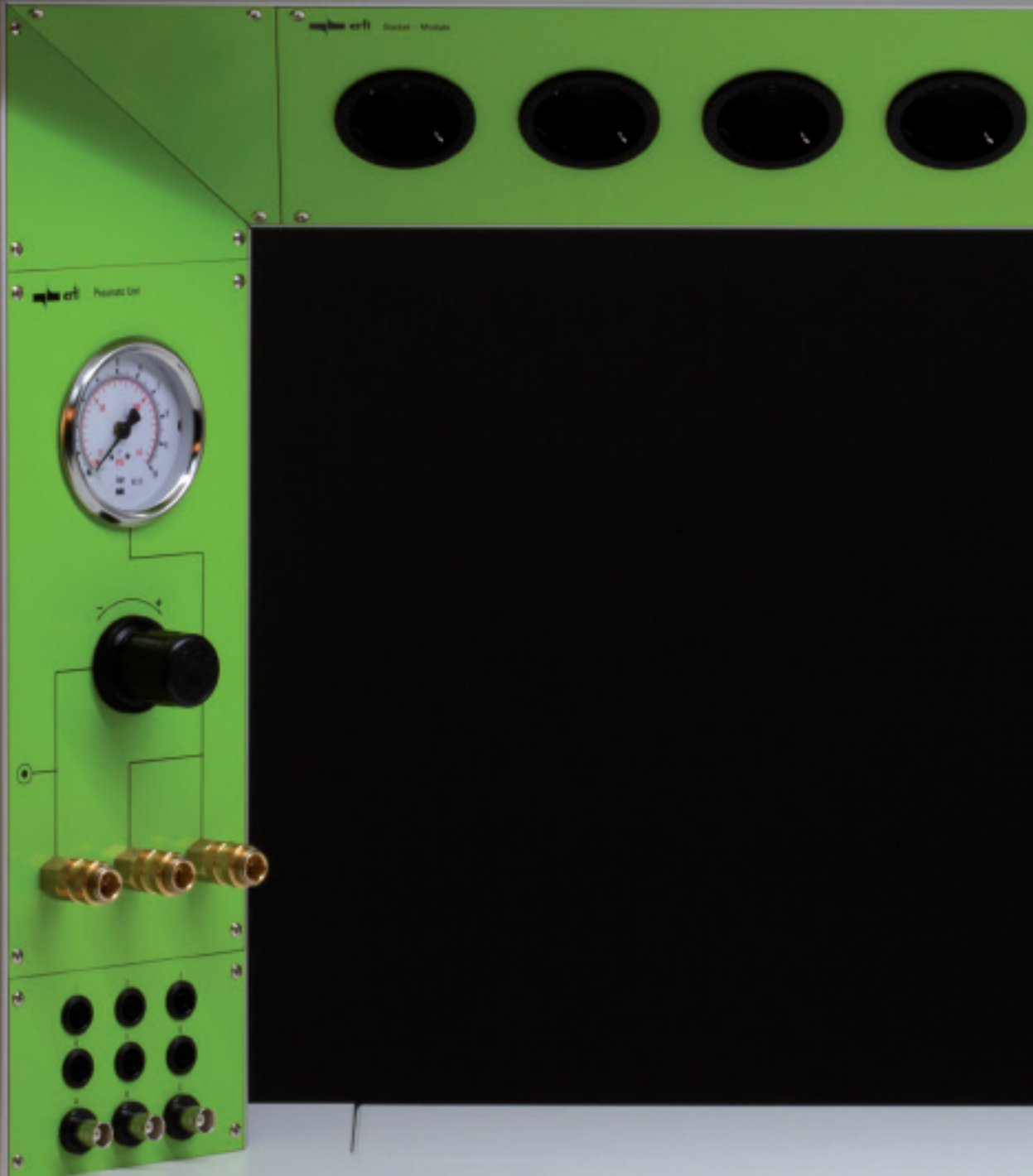
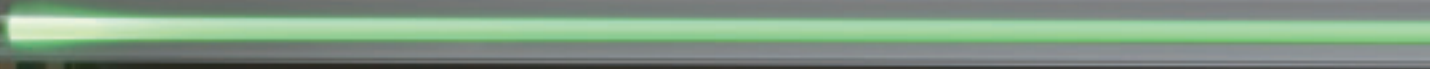

A green control panel with various components:

- Four black circular ports at the top.
- A pressure gauge labeled "Pressure Unit".
- A black rotary knob.
- Three gold-colored connectors.
- A 3x3 grid of black buttons.
- Three gold-colored connectors at the bottom.

The lighting

The in-house development of the lighting of *elneos connect* takes account of the most up-to-date LED technology. At the bottom profile Toplight of the cockpit, the indication lamp is fitted in a round groove on the front and there is also an invisible and swivelling RGB-LED working place illumination.

Indication lamp

The indication lamp is a special LED light conductor which can be operated either as signal indicator or as ambient light. Smooth colour transitions as well as flash functions are also possible. In training centres and the industry, signalling of the table condition is of great importance:

green = everything okay, table switched on,

red = danger, e.g. limit values exceeded

yellow = device with low voltage activated

blue = devices with low voltage and low tension are activated

Working place illumination

In the bottom profile there is the swivelling RGB-LED working light for the table. This light is controlled by powerful RGB-LEDs as well as by white high-performance LEDs. The light can be swivelled in its holder, it is dimmable and any light colours can be adjusted.

The lamp can be fitted to any filing board with the aluminium profile and can be retrofitted with the swivel equipment – thereby the working place is always optimally illuminated.

Another plus is the adaptation of the light colour to the daylight and the reduced formation of shades. In addition, the new lamp is also available as individual lamp, optionally with white LEDs only.



Bright and clear

the lifetime experience

Premium lighting quality

- Light with high power RGB-LEDs as well as with white premium LEDs
- Serially with contactless sensors for dimming and adjustment of light colour
- Fast regulation of desired light climate due to memory function
- RGB-LEDs as well as white LEDs are adjustable independently
- Invisible integrated into profile Toplight
- No additional height for installation
- Rotatable for optimal light control
- Colour fastness and exceptional good contrast
- Free of blending, reflection and shadow
- Homogeneously illuminated surface due to LEDs
- Life cycle up to 50.000 h at 30 % cost saving
- Triggering with I²C bus interface

The drawer unit programme

Design without handles – Touch-to-open technology

The touch-to-open technology opens automatically the drawer when touching the drawer front. Every drawer opens on slight pressure, made possible by a special front fitting and an integrated guard control avoids the unintended opening. Even when both hands are full, the drawers can be opened by slightly tipping with the knee!

Design rollers with a large diameter

Due to their size the runnability of the rollers is superior and their stability is a special feature. The carrying power per roller in motion is 100 kg and when being idle up to 200 kg. The driving noise is almost soundless and this with a minimum of wear and tear.

Solid integrated travelling mechanism

A solid integrated travelling mechanism bears the maximum load of the rollers. For this reason, the rollers cannot be pulled out and withstand the loads in industrial application and in training.

Maintenance-free drawer guiding

The guides have an unequalled long service life due to the built-in automatic self-cleaning of the raceways.



Basic tables

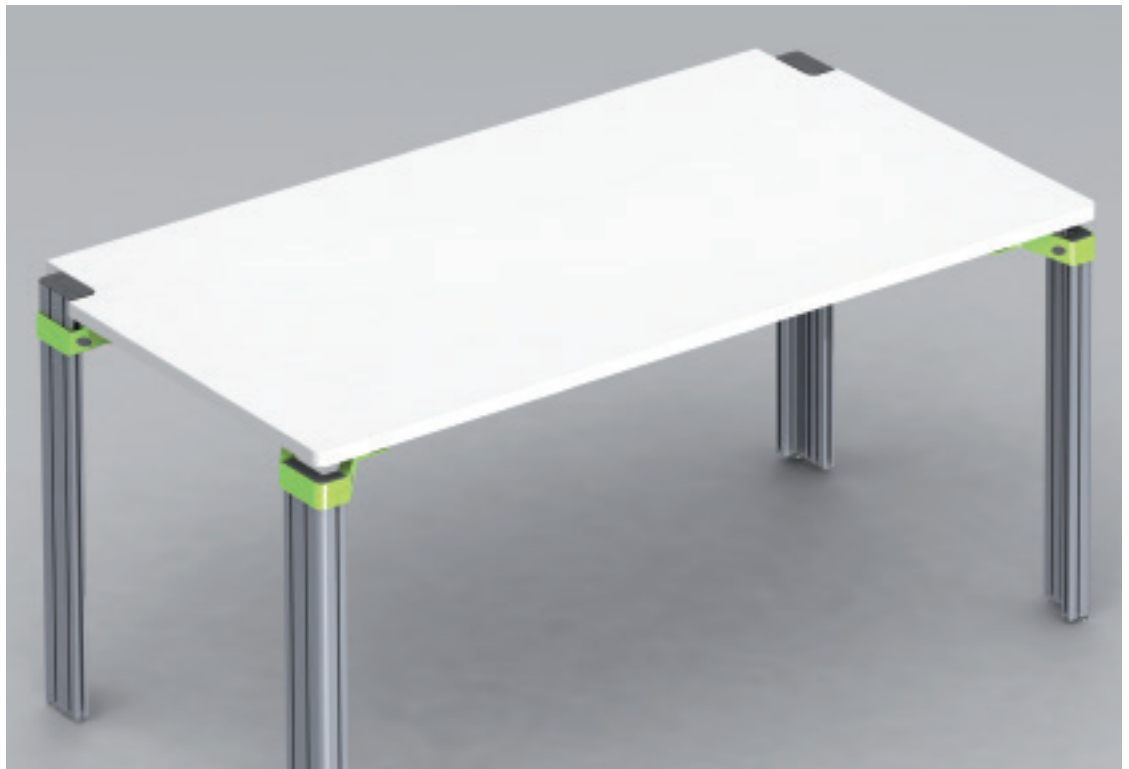

Basic table type 1.1

Work top ergo-line: 30 mm thick HPL high pressure laminated chipboard, front corners with an ergonomic 20 mm rounding (design as opposite), optionally with technical edge alu-line or postforming panel.

Aluminium profile: four aluminium profile feet with two cable chambers for separate media guidance, clip-groove technique to accept expand profiles on the inner surface. 8 grooves for standard sliding blocks and one chamber for the motor driven height adjustment. Stepless mounting at any place of the aluminium table frame; user-defined upward prolongation.

Table frame: solid aluminium table frame; flexible connection of components and considerable weight saving.

Decor work top: noble front white

Connector: central component made of aluminium die casting, elneos green (RAL design system 107070), Alternative colours pure white (RAL 9010), graphite black (RAL 9011) and high gloss chrome;

The main advantages due to the connector

1. Very solid connection of L-profiles with aluminium table frames at any position
2. Feedthrough of expand profiles from the floor to the board and cockpit level on the inner surface
3. Stepless lowering of the table top
4. Spare space below work top for further elements

Tbl 1.1	Length	Depths	ergo-line Standard	ergo-line ESD	alu-line Standard	alu-line ESD	postforming Standard	postforming ESD
1200 mm	850 mm	850 mm	ELC1.1.1281	ELC1.1.1282	ELC1.1.1283	ELC1.1.1284	ELC1.1.1285	ELC1.1.1286
		1000 mm	ELC1.1.1211	ELC1.1.1212	ELC1.1.1213	ELC1.1.1214	ELC1.1.1215	ELC1.1.1216
1600 mm	850 mm	850 mm	ELC1.1.1681	ELC1.1.1682	ELC1.1.1683	ELC1.1.1684	ELC1.1.1685	ELC1.1.1686
		1000 mm	ELC1.1.1611	ELC1.1.1612	ELC1.1.1613	ELC1.1.1614	ELC1.1.1615	ELC1.1.1616
1800 mm	850 mm	850 mm	ELC1.1.1881	ELC1.1.1882	ELC1.1.1883	ELC1.1.1884	ELC1.1.1885	ELC1.1.1886
		1000 mm	ELC1.1.1811	ELC1.1.1812	ELC1.1.1813	ELC1.1.1814	ELC1.1.1815	ELC1.1.1816
2000 mm	850 mm	850 mm	ELC1.1.2081	ELC1.1.2082	ELC1.1.2083	ELC1.1.2084	ELC1.1.2085	ELC1.1.2086
		1000 mm	ELC1.1.2011	ELC1.1.2012	ELC1.1.2013	ELC1.1.2014	ELC1.1.2015	ELC1.1.2016

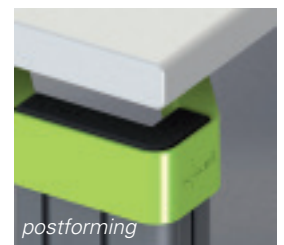
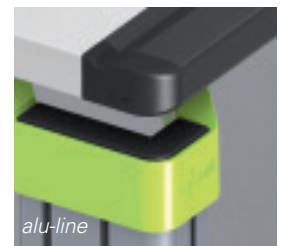
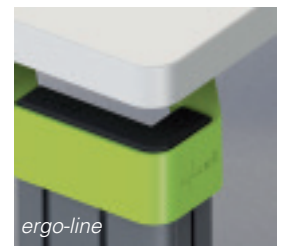

Basic table type 1.2

Design as 1.1, however, with additional cable flap and integrated cable tray

Cable flap: 180° openable, divided flap possible

Cable tray: flexibly mountable to the aluminium functional frame (160mm usable depth)

Work tops of conductive ESD design

All work tops are optionally available as ESD design and with the decor *front white*. With the work top *alu-line* the plastic covering of the aluminium profile is made of conductive plastics. Conductive plastics have different flow properties in the production process. To obtain an optimal form fit with the table top in case of the conductive design, a special tool has been developed

ergo-line: front corners at left and right-hand side, rounded with a radius of 20mm, to avoid to strike against the table corners; 30 mm thick HPL-high pressure laminated chipboard

alu-line: front edge with aluminium core inclusive functional grooves on the underside for connecting bench vices or similar items; top side and front made of sturdy special plastic profile, inclusive filing tray and horizontal corrugation at the front as protection against damage; 30 mm thick HPL-high pressure laminated chipboard;

Postforming: front longitudinal edge with postforming rounding; 30 mm thick HPL-high pressure laminated chipboard;

Tbl 1.2	Length	Depths	ergo-line	ergo-line	alu-line	alu-line	postforming	postforming
			Standard	ESD	Standard	ESD	Standard	ESD
	1200 mm	850 mm	ELC1.2.1281	ELC1.2.1282	ELC1.2.1283	ELC1.2.1284	ELC1.2.1285	ELC1.2.1286
		1000 mm	ELC1.2.1211	ELC1.2.1212	ELC1.2.1213	ELC1.2.1214	ELC1.2.1215	ELC1.2.1216
	1600 mm	850 mm	ELC1.2.1681	ELC1.2.1682	ELC1.2.1683	ELC1.2.1684	ELC1.2.1685	ELC1.2.1686
		1000 mm	ELC1.2.1611	ELC1.2.1612	ELC1.2.1613	ELC1.2.1614	ELC1.2.1615	ELC1.2.1616
	1800 mm	850 mm	ELC1.2.1881	ELC1.2.1882	ELC1.2.1883	ELC1.2.1884	ELC1.2.1885	ELC1.2.1886
		1000 mm	ELC1.2.1811	ELC1.2.1812	ELC1.2.1813	ELC1.2.1814	ELC1.2.1815	ELC1.2.1816
	2000 mm	850 mm	ELC1.2.2081	ELC1.2.2082	ELC1.2.2083	ELC1.2.2084	ELC1.2.2085	ELC1.2.2086
		1000 mm	ELC1.2.2011	ELC1.2.2012	ELC1.2.2013	ELC1.2.2014	ELC1.2.2015	ELC1.2.2016

Basic tables



Basic table type 1.3

Design as 1.1, however, with lowerable cable flap and integrated cable tray.

Cable tray: flexibly mountable (200 mm usable depth); further details in the catalogue *erfi instruments*, pg. 44.

Cable flap: openable inwardly with 2 brush rails and 2 opening positions (centred and complete)

Advantages

- Opening without requiring physical effort and unequalled quick access due to the functions One-Finger-Touch and Quick Access.
- Perfect sorting of the emergent media on the table top (2 brushes); no overhang of the cable flap whatsoever during opening and closing;
- Improved accessibility (front brush); optimization of the working surface (front brush); optimization of the working surface (rear brush);
- Lateral cable outlet due to lateral brushes.

Tbl 1.3	Length	Depths	ergo-line Standard	ergo-line ESD	alu-line Standard	alu-line ESD	postforming Standard	postforming ESD
1200 mm	850 mm	850 mm	ELC1.3.1281	ELC1.3.1282	ELC1.3.1283	ELC1.3.1284	ELC1.3.1285	ELC1.3.1286
		1000 mm	ELC1.3.1211	ELC1.3.1212	ELC1.3.1213	ELC1.3.1214	ELC1.3.1215	ELC1.3.1216
1600 mm	850 mm	850 mm	ELC1.3.1681	ELC1.3.1682	ELC1.3.1683	ELC1.3.1684	ELC1.3.1685	ELC1.3.1686
		1000 mm	ELC1.3.1611	ELC1.3.1612	ELC1.3.1613	ELC1.3.1614	ELC1.3.1615	ELC1.3.1616
1800 mm	850 mm	850 mm	ELC1.3.1881	ELC1.3.1882	ELC1.3.1883	ELC1.3.1884	ELC1.3.1885	ELC1.3.1886
		1000 mm	ELC1.3.1811	ELC1.3.1812	ELC1.3.1813	ELC1.3.1814	ELC1.3.1815	ELC1.3.1816
2000 mm	850 mm	850 mm	ELC1.3.2081	ELC1.3.2082	ELC1.3.2083	ELC1.3.2084	ELC1.3.2085	ELC1.3.2086
		1000 mm	ELC1.3.2011	ELC1.3.2012	ELC1.3.2013	ELC1.3.2014	ELC1.3.2015	ELC1.3.2016

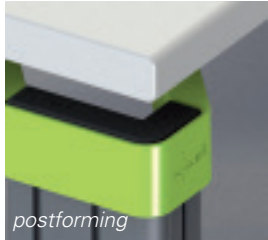
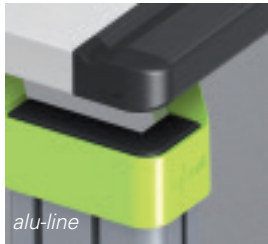
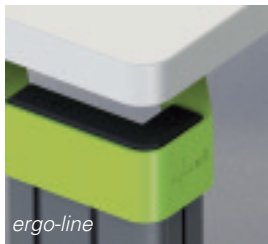

Basic table type 1.4

Design as 1.1, however, with cable flap and integrated lowered supply terminal for the variable equipment with the intelligent compact device programme *acto*.

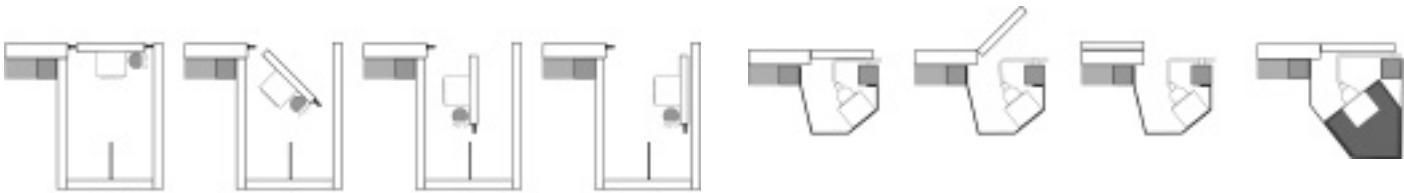

foldaway cable flap (Table 1.3)

180° cable flap (Table 1.2)

supply terminal (Table 1.4)

Tbl 1.4	Length	Depths	ergo-line		alu-line		postforming	
			Standard	ESD	Standard	ESD	Standard	ESD
1200 mm	850 mm	850 mm	ELC1.4.1281	ELC1.4.1282	ELC1.4.1283	ELC1.4.1284	ELC1.4.1285	ELC1.4.1286
		1000 mm	ELC1.4.1211	ELC1.4.1212	ELC1.4.1213	ELC1.4.1214	ELC1.4.1215	ELC1.4.1216
1600 mm	850 mm	850 mm	ELC1.4.1681	ELC1.4.1682	ELC1.4.1683	ELC1.4.1684	ELC1.4.1685	ELC1.4.1686
		1000 mm	ELC1.4.1611	ELC1.4.1612	ELC1.4.1613	ELC1.4.1614	ELC1.4.1615	ELC1.4.1616
1800 mm	850 mm	850 mm	ELC1.4.1881	ELC1.4.1882	ELC1.4.1883	ELC1.4.1884	ELC1.4.1885	ELC1.4.1886
		1000 mm	ELC1.4.1811	ELC1.4.1812	ELC1.4.1813	ELC1.4.1814	ELC1.4.1815	ELC1.4.1816
2000 mm	850 mm	850 mm	ELC1.4.2081	ELC1.4.2082	ELC1.4.2083	ELC1.4.2084	ELC1.4.2085	ELC1.4.2086
		1000 mm	ELC1.4.2011	ELC1.4.2012	ELC1.4.2013	ELC1.4.2014	ELC1.4.2015	ELC1.4.2016

L-profile for integral modular tables



The L-profile made of one piece

Device cockpits and filing boards are mounted to rear profiles. Optionally, the rear foot profiles can be extended (heightening profiles, see following page). The profiles made of one piece offer a maximum of stability due to their shape and their uninterrupted structure. The profiles which can be heightened allow an optimal flexibility as regards extension and modification.

Note scope of delivery: L-profile inclusive profile cover cap made of plastics and levelling foot;



Persistent leg profiles

Profile legths rear leg incl. leg adjuster	Reference No.	Notes
702 mm	ELC2.1.0702	forward table legs
780 mm	ELC2.1.0780	rear table legs
1.200 mm	ELC2.1.1200	rear table legs
1.400 mm	ELC2.1.1400	rear table legs
1.500 mm	ELC2.1.1500	rear table legs
1.800 mm	ELC2.1.1800	rear table legs
2.000 mm	ELC2.1.2000	rear table legs
2.200 mm	ELC2.1.2200	rear table legs

L-profile for heightened modular tables

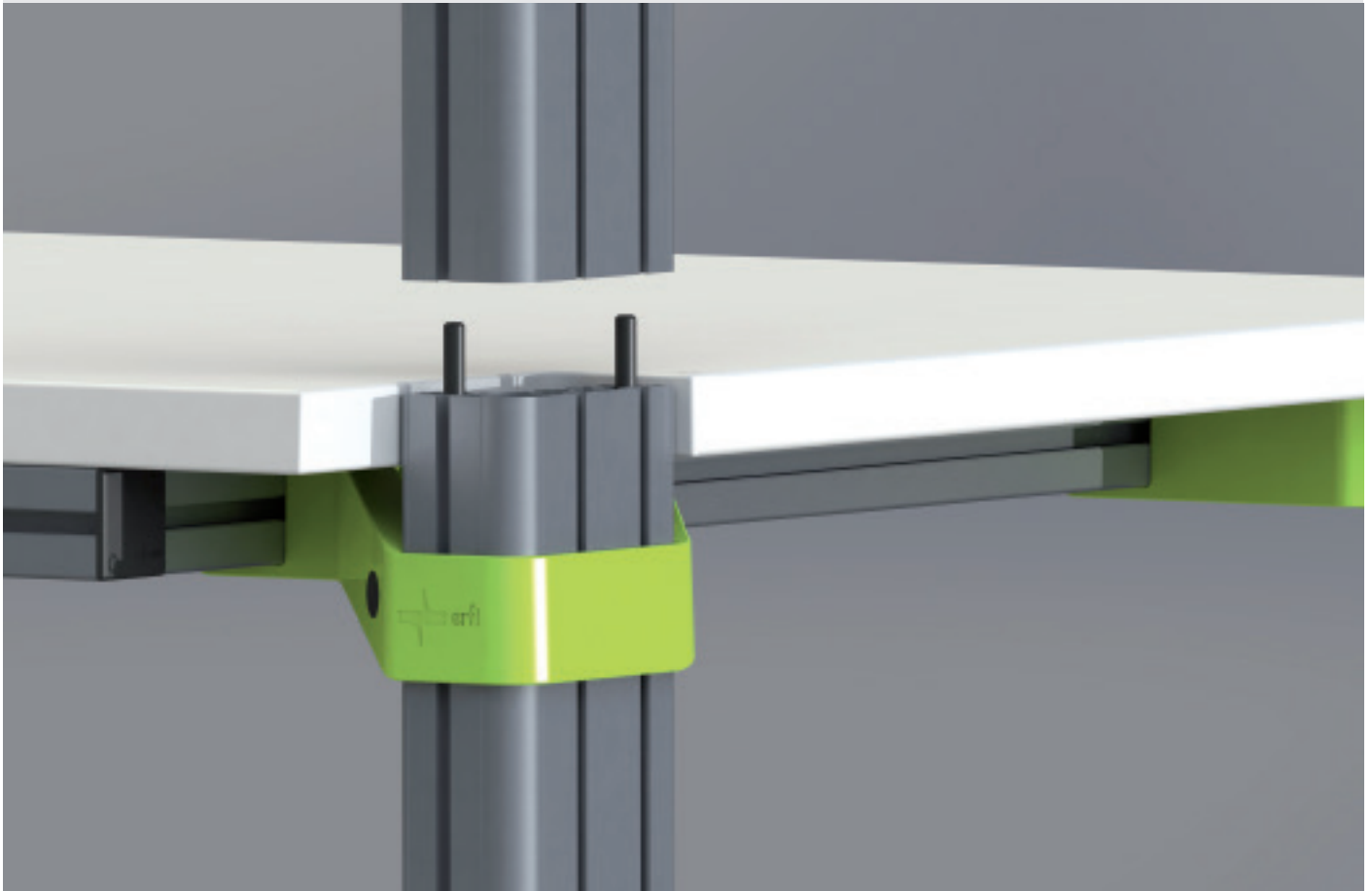

The L-profile for heightening

The L-profile offers the possibility of extending at will the rear profile feet by means of a heightening profile.

Heightening is realized by means of inside pins which engage with the respective cylinders of the bottom L-profile, simultaneously acting as protection against torsion. In addition, the profiles are secured. A highly solid connection which is invisible from the outside when being assembled.

Extended leg profiles		
from	to	Reference No.
780 mm	1.000 mm	ELC2.2.0220
	1.200 mm	ELC2.2.0420
	1.400 mm	ELC2.2.0620
	1.500 mm	ELC2.2.0720
	1.800 mm	ELC2.2.1020
	2.000 mm	ELC2.2.1220
	2.200 mm	ELC2.2.1420
	ceiling height*	ELC2.2.DH78
1.200 mm	1.400 mm	ELC2.2.0200
	1.500 mm	ELC2.2.0300
	1.800 mm	ELC2.2.0600
	2.000 mm	ELC2.2.0800
	2.200 mm	ELC2.2.1000
	ceiling height*	ELC2.2.DH12

Extended leg profiles		
from	to	Reference No.
1.400 mm	1.800 mm	ELC2.2.0400
	2.000 mm	ELC2.2.0600
	2.200 mm	ELC2.2.0800
	ceiling height*	ELC2.2.DH14
1.500 mm	1.800 mm	ELC2.2.0300
	2.000 mm	ELC2.2.0300
	2.200 mm	ELC2.2.0700
	ceiling height*	ELC2.2.DH15
1.800 mm	2.000 mm	ELC2.2.0200
	2.200 mm	ELC2.2.0400
	ceiling height*	ELC2.2.DH18
2.000 mm	2.200 mm	ELC2.2.0200
	ceiling height*	ELC2.2.DH20
2.200 mm	ceiling height*	ELC2.2.DH22

Note scope of delivery: L-profile inclusive profile cover cap made of plastics and 2 heightening pins;
 Note*: Please indicate the ceiling height!

elneos connect – the lifetime experience

Filing boards for modular tables



Filing boards for modular tables



Straight filing boards, variable in height

20 mm thick wooden chipboard, laminate coated, edges all around with high-impact 2 mm ABS plastic profile; infinitely adjustable in height, inclusive supported aluminium profile with functional grooves;

Decor: noble front white

Optional design: without supported aluminium profile, for the direct placing on a horizontal expand profile; each one of ESD design (volume conductive);

Inclinable filing boards, variable in height

20 mm thick wooden chipboard, laminate coated, edges all around with high-impact 2 mm ABS plastic profile; infinitely adjustable in height and inclinable, front sides with embedded anti-slip edge, inclusive supported aluminium profile with functional grooves;

Decor: noble front white

Optional design: volume conductive EGB/ESD design

Linear filing boards					
Length	Depths	with underlying aluminium profile		w/o underlying aluminium profile	
		Standard	ESD	Standard	ESD
1200 mm	360 mm	ELC3.1.1231	ELC3.1.1232	ELC3.2.1231	ELC3.2.1232
	500 mm	ELC3.1.1251	ELC3.1.1252	ELC3.2.1251	ELC3.2.1252
1600 mm	360 mm	ELC3.1.1631	ELC3.1.1632	ELC3.2.1631	ELC3.2.1632
	500 mm	ELC3.1.1651	ELC3.1.1652	ELC3.2.1651	ELC3.2.1652
1800 mm	360 mm	ELC3.1.1831	ELC3.1.1832	ELC3.2.1831	ELC3.2.1832
	500 mm	ELC3.1.1851	ELC3.1.1852	ELC3.2.1851	ELC3.2.1852
2000 mm	360 mm	ELC3.1.2031	ELC3.1.2032	ELC3.2.2031	ELC3.2.2032
	500 mm	ELC3.1.2051	ELC3.1.2052	ELC3.2.2051	ELC3.2.2052

Inclinable filing boards	
with underlying aluminium profile	
Standard	ESD
ELC3.3.1231	ELC3.3.1232
ELC3.3.1251	ELC3.3.1252
ELC3.3.1631	ELC3.3.1632
ELC3.3.1651	ELC3.3.1652
ELC3.3.1831	ELC3.3.1832
ELC3.3.1851	ELC3.3.1852
ELC3.3.2031	ELC3.3.2032
ELC3.3.2051	ELC3.3.2052

Functional profiles for filing boards



Aluminium functional profile Top

The aluminium profile Top on the front ensures an intelligent impact protection on the filing level and due to functional grooves on the top side and underside allows an intelligent connection of many system components. The profile structure of the inside allows also the additional wiring of tables among each other due to the integrated big cable chamber. The profile is serially equipped with a stopper edge at the front which is particularly useful with inclinable filing boards and simultaneously defines the stop.

The functional profile for filing boards

The front edge of the filing board can additionally be equipped with two innovative aluminium profiles.

Aluminium functional profile Top, ath the front	
Board length	Reference No.
1.200 mm	ELC2.3.1200
1.600 mm	ELC2.3.1600
1.800 mm	ELC2.3.1800
2.000 mm	ELC2.3.2000

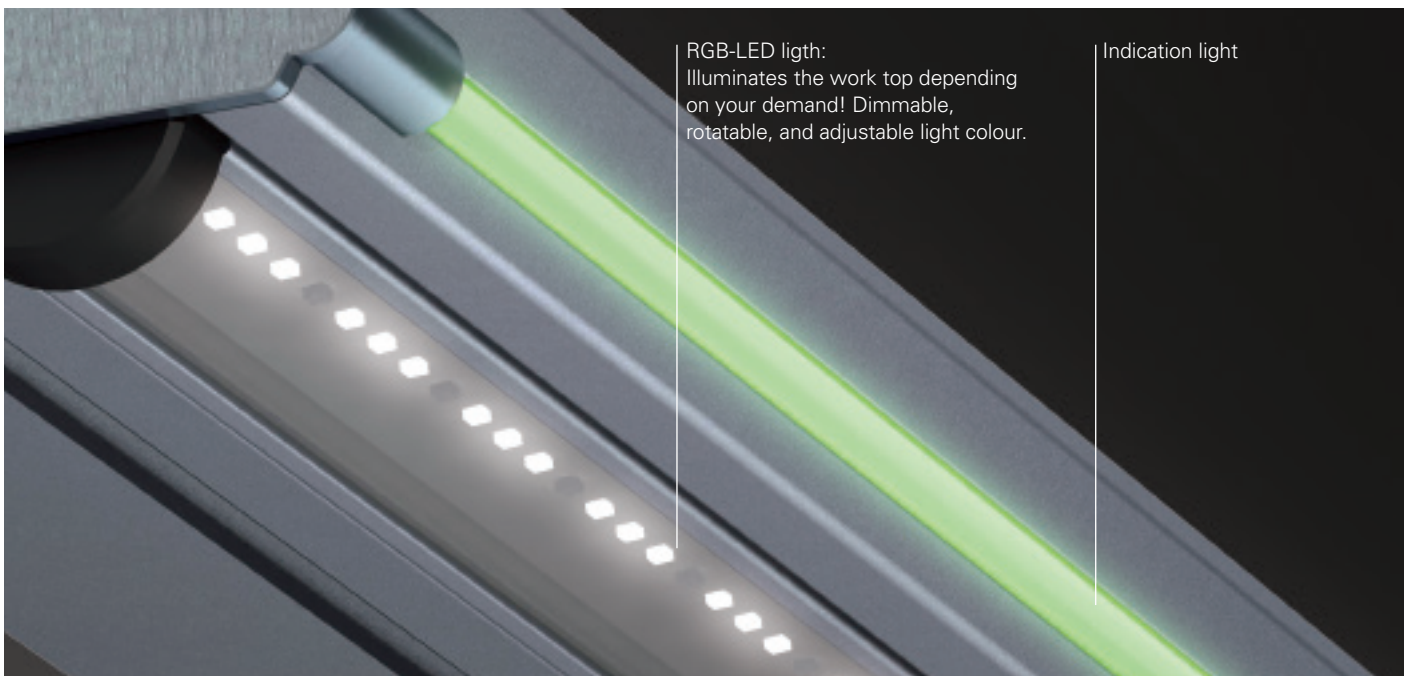
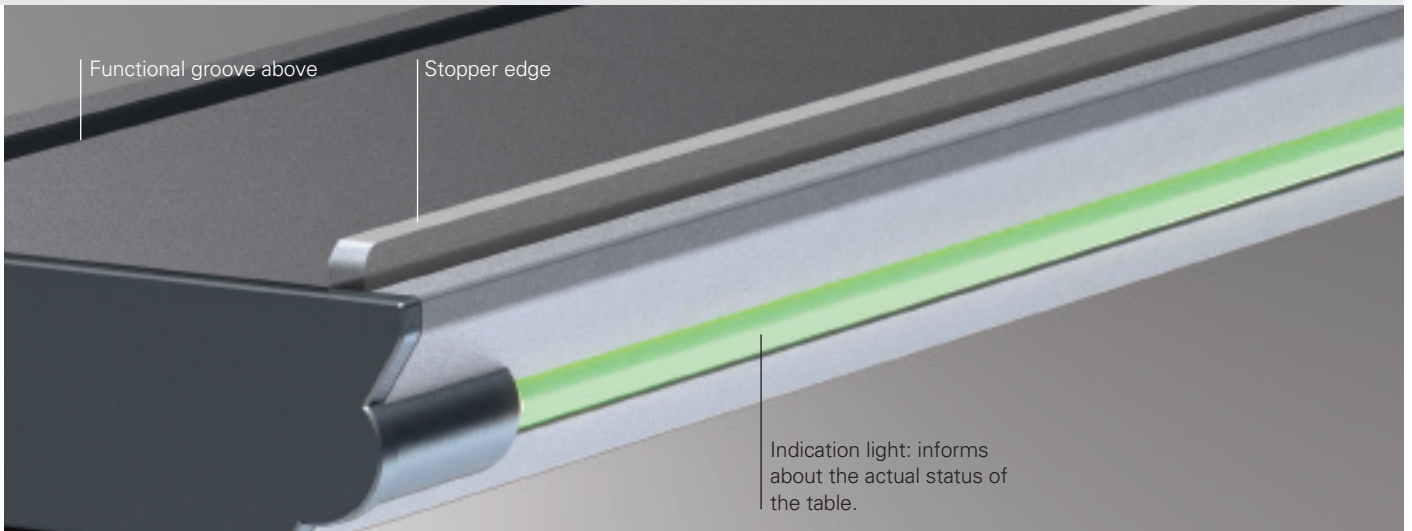

Aluminium functional profile Toplight

The profile Toplight is provided with a functional groove on the top side and underside just like the profile Top. A stopper edge is also integrated. As an option, the profile can accept the new swivelling and dimmable RGB-LED lamp as well as the indication lamp on the front (see following pages). On the underside the profile has a holding fixture for the newly developed LED lamp family.

Basic design: without light

Option 1: LED lamp with white LEDs; swivelling and dimmable by means of contact-free sensor;

Option 2: with additional RGB-LEDs; colour balance additionally tunable by means of two contact-free sensors;

Option 3: with indication lamp; The indication lamp is on the front of the aluminium profile and is provided with its own intelligence. It indicates always the present condition of the laboratory table and thus, improves decisively the safety at the working place.

Aluminium functional profile Toplight, at the front	
Board length	Reference No.
1.200 mm	ELC2.4.1200
1.600 mm	ELC2.4.1600
1.800 mm	ELC2.4.1800
2.000 mm	ELC2.4.2000

Note: Ordering numbers for LED lamps and the indication lamp are listed on the following pages.

elneos connect – the lifetime experience

LED working place lamp

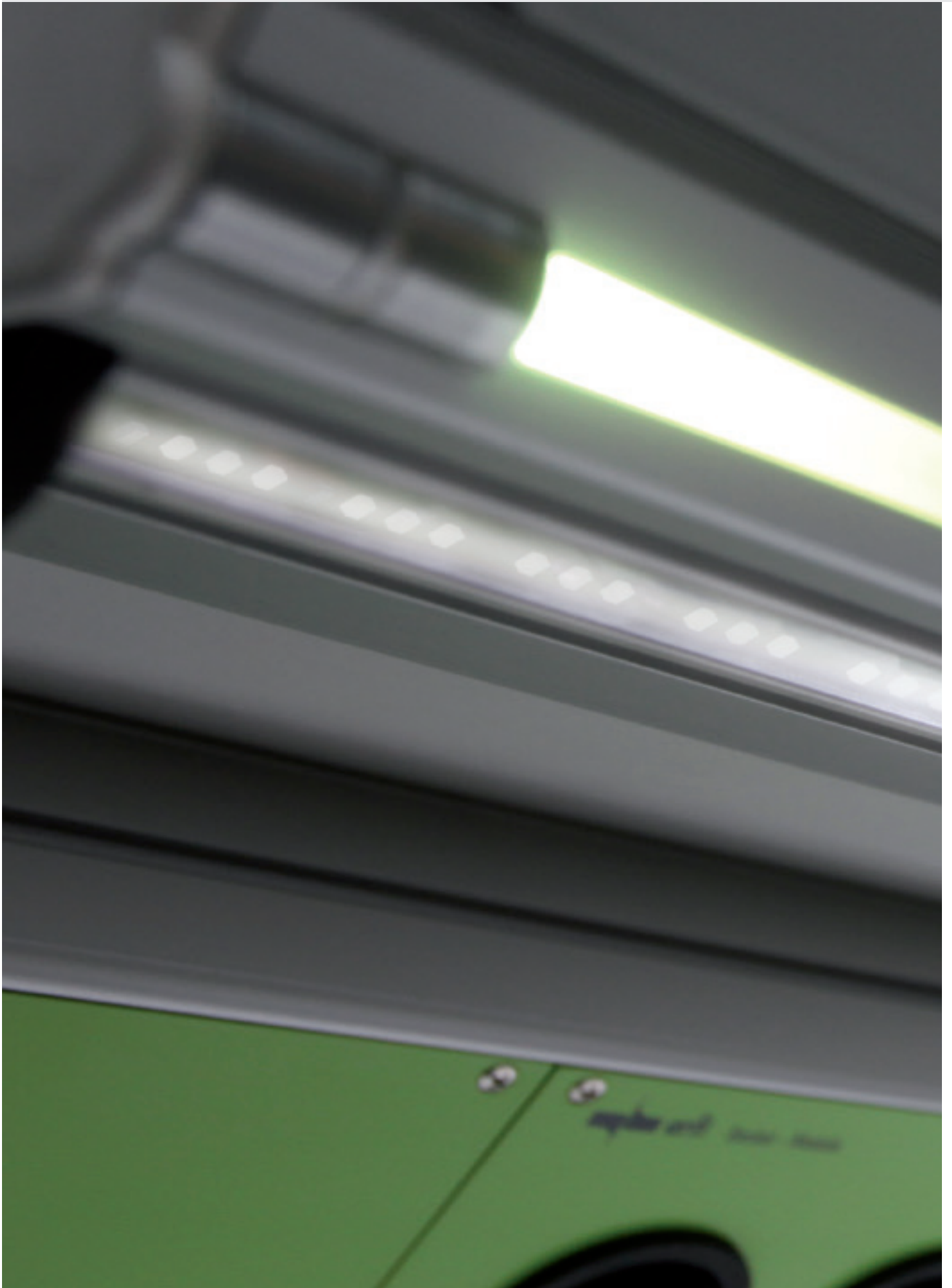

Sensory controlled LED working place lamp

The innovative working place lamps of *elneos connect* have been so developed that they do not require any additional space at the working place and simultaneously ensure a maximum of benefit and convenience.

Intelligent sensors take over the complete control of the lighting technology. The lamps are operated and dimmed contact-free – also the colour balance and the light intensity are adapted contact-free by the up-to-date sensor technology.

By a slight approach of the hand to the respective sensor, the lamp adjusts its colour range according to an intelligent algorithm. When the desired light intensity is obtained, the hand can be withdrawn from the sensor and the lamp keeps the adjusted colour. The last adjusted light intensity is stored (memory effect). The design of the new lamps is based on the modern LED technology. The in-house development of the lamp family allows new concepts and the in-house production of the lamps in our Freudenstadt facility guarantee a constantly high quality and the best of service.

The lamps are invisibly integrated in the aluminium functional profile Toplight (see previous page), are provided with anti-glare and are swivelling. No additional space is required underneath the filing board or device cockpit.

Special features

- Invisible LED working place lamp, integrated in the aluminium functional profile Toplight
- No wasted space underneath board or cockpit
- Swivelling LED lamp for light guidance
- Integrated anti-glare system
- As an option with white LEDs or with additional RGB-LEDs (mixed equipment)
- Contact-free sensor for switching and dimming (proximity sensor)
- Contact-free sensor for regulating the light intensity. A defined algorithm allows the adjustment of the desired light intensity.
- Steady illumination of the working surface without forming shades
- Interface for external control by I²C bus interface. This allows to remote control the lamp also with the device series *elneos five*.
- Different lengths, adapted to the table length concerned.
- The retrofit in the aluminium functional profile Toplight is possible at any time.
- Solo application of the light fixtures possible without the aluminium functional profile Toplight because the light fixture consists of one compact aluminium profile.

Sensory controlled LED working place light with white premium high power LEDs

Table length	integrated in aluminium functional profile Toplight	w/o aluminium functional profile Toplight	<ul style="list-style-type: none"> • High power LEDs for strong illumination • Sensoric controllable and dimmable • Rotatable • Integrated anti-glare system • I²C bus interface
1.200 mm	ELC2.5.1200.WA	ELC2.6.1200.W	
1.600 mm	ELC2.5.1600.WA	ELC2.6.1600.W	
1.800 mm	ELC2.5.1800.WA	ELC2.6.1800.W	
2.000 mm	ELC2.5.2000.WA	ELC2.6.2000.W	

Sensory controlled LED working place light with white and RGB premium high power LEDs

Table length	integrated in aluminium functional profile Toplight	w/o aluminium functional profile Toplight	<ul style="list-style-type: none"> • High power LEDs for strong illumination • Sensoric controllable and dimmable and rotatable • Integrated anti-glare system • Additional sensor for regulating the light colour • I²C bus interface
1.200 mm	ELC2.7.1200.FA	ELC2.8.1200.F	
1.600 mm	ELC2.7.1600.FA	ELC2.8.1600.F	
1.800 mm	ELC2.7.1800.FA	ELC2.8.1800.F	
2.000 mm	ELC2.7.2000.FA	ELC2.8.2000.F	

elneos connect – the lifetime experience

RGB-LED indication lamp

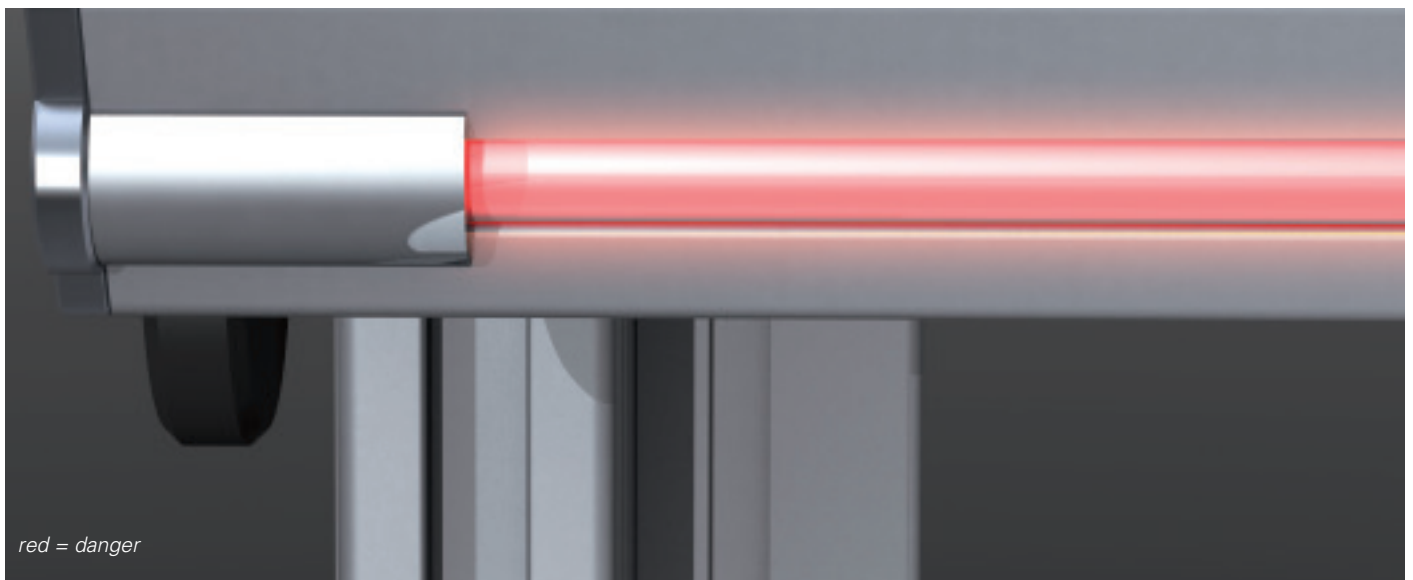
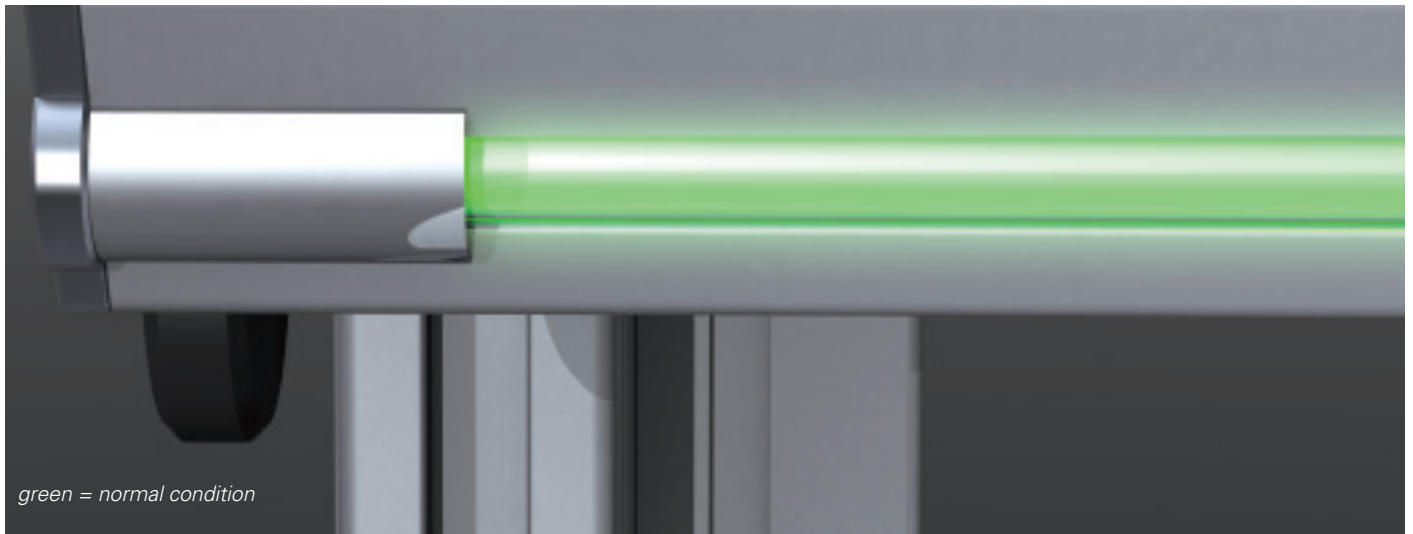

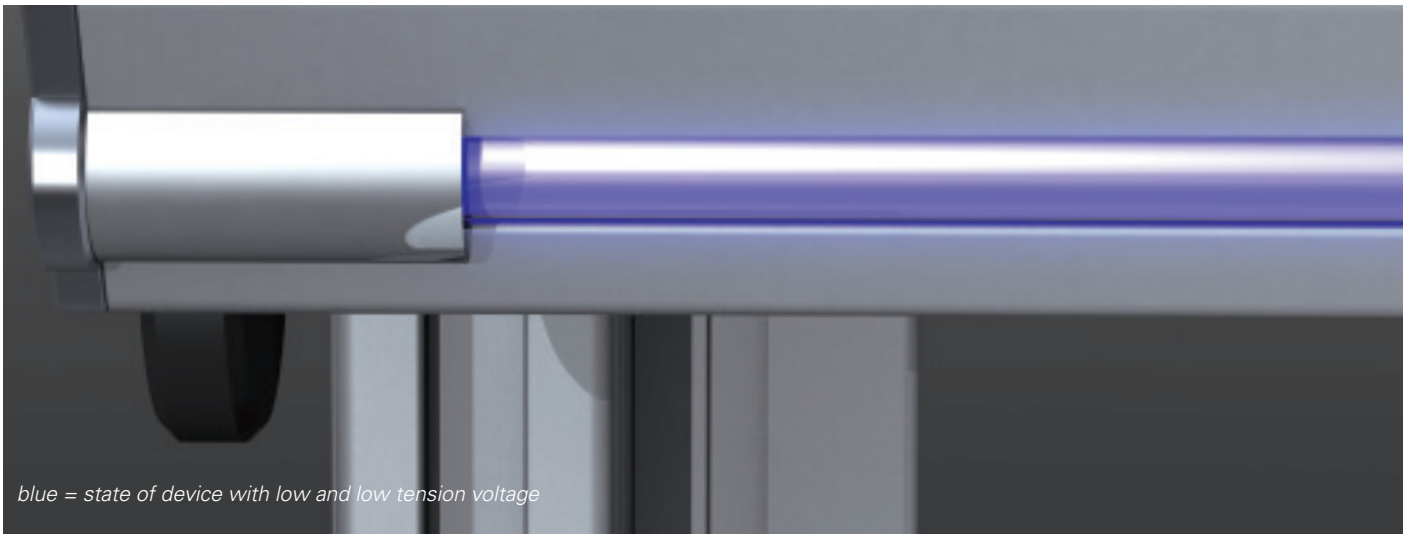

blue = state of device with low and low tension voltage

Intelligent indication lamp

The indication lighting ensures an increased safety at the working place. This invention proves again the technological leadership of erfi.

An intelligent RGB light-band across the entire table length informs the user and others of the present condition of the laboratory place. The light-band is operated with high-performance RGB-LEDs and the special feature of the same is the uniform distribution and intensity of the amount of light along the front.

The light-band is integrated in the aluminium functional profile Toplight and indicates to the front the present condition of the table even when the environment is strongly lightened. The indication lamp is equipped with and self-sufficient power supply as well we with independent control electronics.

Indication colours

Normal condition: Laboratory table is switched on and works normally;

Danger: e.g. limit values exceeded (limit values for voltage or electricity of multimeters, generators and the like);

State of device: Devices with low voltage are activated;

State of device: Devices with low voltage and low tensions are activated;

Additionally indicated conditions

- Pulsing and blinking of a certain colour;
- EMERGENCY STOP tracer – When being operated the indicator is pulsing red and the identification of the person who might be in danger, is immediately possible;
- The activation can be realised – but must not be realised – by the device series elneos five;
- The individual switching status can be activated directly and the indication light can be used as *Ambilight* without equipment technology.

RGB-LED Indikation Light

Table length	Integrated in aluminium functional profile Toplight	
1.200 mm	ELC2.9.1200.I	<ul style="list-style-type: none"> • Integrated in aluminium functional profile Toplight • High power RGB-LEDs for strong illumination • Emitting indicator via the complete length of table • Provides high security at the working place
1.600 mm	ELC2.9.1600.I	
1.800 mm	ELC2.9.1800.I	
2.000 mm	ELC2.9.2000.I	

elneos connect – the lifetime experience

Table attachment for modular tables





19" table attachments 3 and 6 HU

Suitable for all standardised 19" device systems; inclusive aluminium functional profile at the top of the front. At the top of the aluminium profile there is a semicircular filing groove which can ideally be used for small items and tools.

Optional design

Volume conductive ESD design, device front 3 HE and 6 HE inclined by 10°;

19" table attachments 3 and 6 HU					
Length/BK*	Depths	3 HU (height 172 mm)		6 HU (height 305 mm)	
		Standard	ESD	Standard	ESD
1.200 mm/235 DU	260 mm	ELC4.3.1221	ELC4.3.1222	ELC4.4.1221	ELC4.4.1222
	360 mm	ELC4.3.1231	ELC4.3.1232	ELC4.4.1231	ELC4.4.1232
	500 mm	ELC4.3.1251	ELC4.3.1252	ELC4.4.1251	ELC4.4.1252
1.600 mm/313 DU	260 mm	ELC4.3.1621	ELC4.3.1622	ELC4.4.1621	ELC4.4.1622
	360 mm	ELC4.3.1631	ELC4.3.1632	ELC4.4.1631	ELC4.4.1632
	500 mm	ELC4.3.1651	ELC4.3.1652	ELC4.4.1651	ELC4.4.1652
1.800 mm/352 DU	260 mm	ELC4.3.1821	ELC4.3.1822	ELC4.4.1821	ELC4.4.1822
	360 mm	ELC4.3.1831	ELC4.3.1832	ELC4.4.1831	ELC4.4.1832
	500 mm	ELC4.3.1851	ELC4.3.1852	ELC4.4.1851	ELC4.4.1852
2.000 mm/391 DU	260 mm	ELC4.3.2021	ELC4.3.2022	ELC4.4.2021	ELC4.4.2022
	360 mm	ELC4.3.2031	ELC4.3.2032	ELC4.4.2031	ELC4.4.2032
	500 mm	ELC4.3.2051	ELC4.3.2052	ELC4.4.2051	ELC4.4.2052

Additional price for device fronts inclined by 10°: Reference No. ELC4.5.0001 (independent of the installation size)

*BK = Capacity in DU (depths unit) 1 DU = 5,08 mm

elneos connect – the lifetime experience

Cockpits for modular tables





19" Cockpits 3 and 6 HU

Suitable for all standardised 19" device systems, infinitely adjustable in height, inclusive aluminium functional profile Top/Toplight on the front to accept the RGB LED lamps and the indication lighting.

Optional design

Volume conductive ESD design without supported aluminium profile for direct placing on the horizontal Expand profile 2; device front 3 HU inclined by 10° and infinitely inclinable.

19" Cockpits 3 and 6 HU

Lenth/BK*	Depths	3 HU (height 172 mm)		6 HU (height 305 mm)	
		Standard	ESD	Standard	ESD
1.200 mm/235 DU	260 mm	ELC4.1.1221	ELC4.1.1222	ELC4.2.1221	ELC4.2.1222
	360 mm	ELC4.1.1231	ELC4.1.1232	ELC4.2.1231	ELC4.2.1232
	500 mm	ELC4.1.1251	ELC4.1.1252	ELC4.2.1251	ELC4.2.1252
1.600 mm/313 DU	260 mm	ELC4.1.1621	ELC4.1.1622	ELC4.2.1621	ELC4.2.1622
	360 mm	ELC4.1.1631	ELC4.1.1632	ELC4.2.1631	ELC4.2.1632
	500 mm	ELC4.1.1651	ELC4.1.1652	ELC4.2.1651	ELC4.2.1652
1.800 mm/352 DU	260 mm	ELC4.1.1821	ELC4.1.1822	ELC4.2.1821	ELC4.2.1822
	360 mm	ELC4.1.1831	ELC4.1.1832	ELC4.2.1831	ELC4.2.1832
	500 mm	ELC4.1.1851	ELC4.1.1852	ELC4.2.1851	ELC4.2.1852
2.000 mm/391 DU	260 mm	ELC4.1.2021	ELC4.1.2022	ELC4.2.2021	ELC4.2.2022
	360 mm	ELC4.1.2031	ELC4.1.2032	ELC4.2.2031	ELC4.2.2032
	500 mm	ELC4.1.2051	ELC4.1.2052	ELC4.2.2051	ELC4.2.2052

Additional price for device fronts inclined by 10°: Reference No. EL4.3.0001 (independent of the installation size)

Additional price for infinitely inclinable device cockpit: Reference No. EL4.3.0002 (independent of the installation size)

*BK = Capacity in DU (depths unit) 1 DU = 5,08 mm

elneos connect – the lifetime experience

Expand profile 1

*When Expand profile 1 is installed,
various media cables can be carried
to the front easily.*

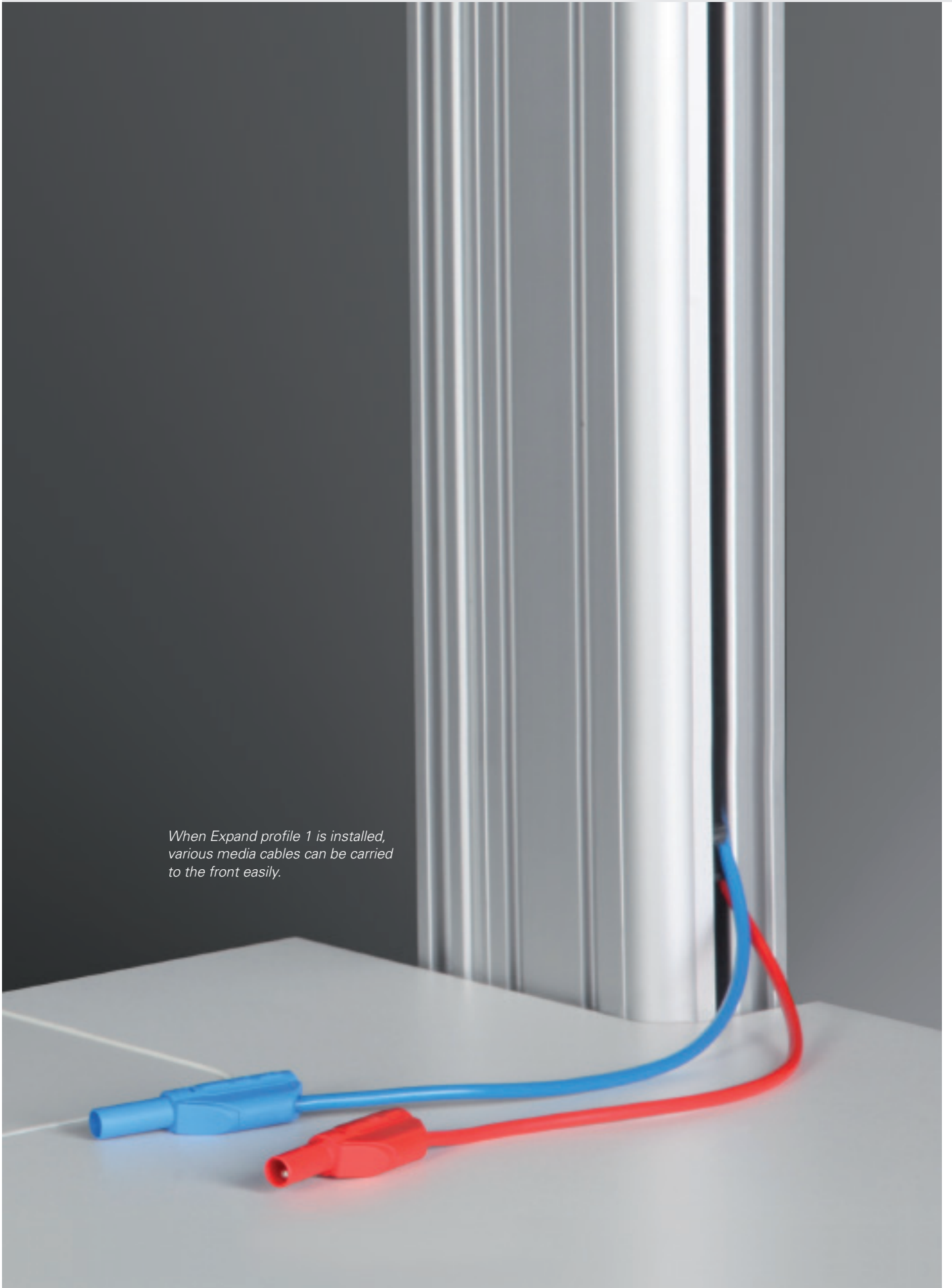

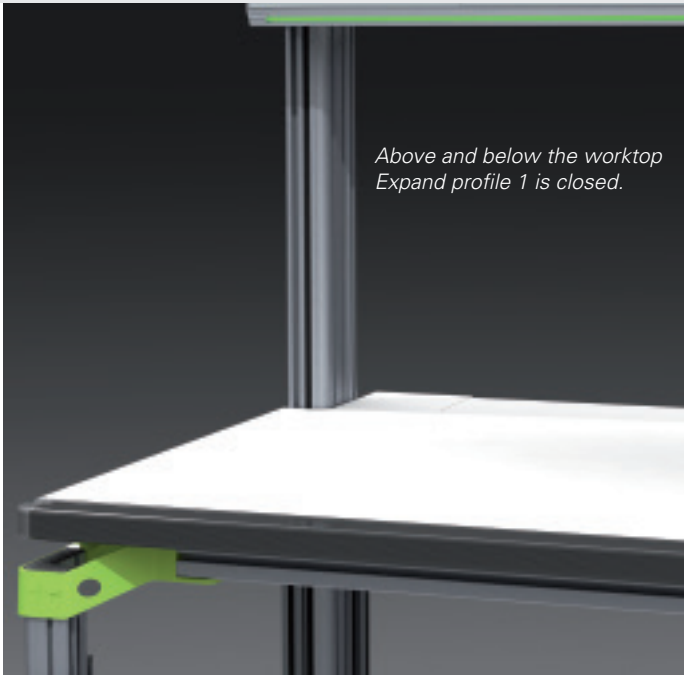

Above and below the worktop Expand profile 1 is closed.

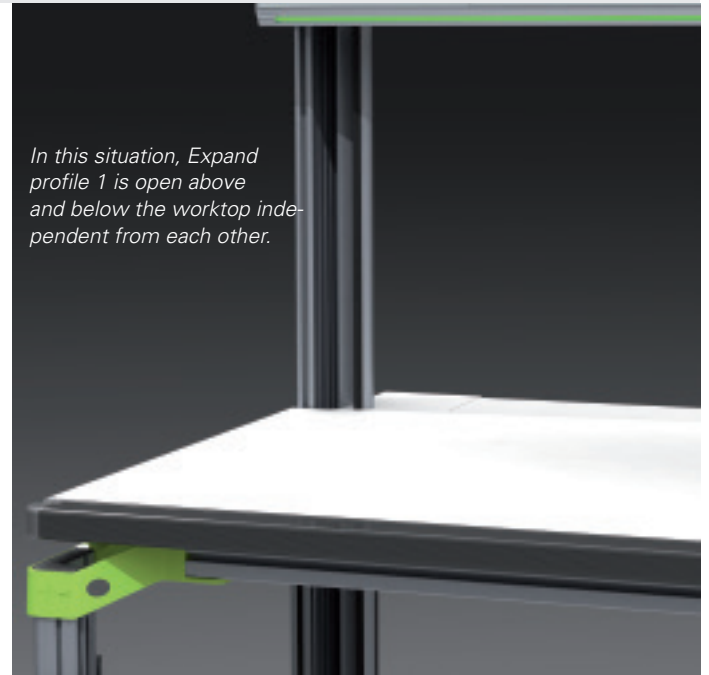

In this situation, Expand profile 1 is open above and below the worktop independent from each other.

The Expand profile 1 – a clipping profile

The profile can elegantly be clipped to the inner surface of the L-profile. It is provided with two cable chambers and a brush rail at the front through which the cable of the front cable chamber can be passed forward to the user across the entire height of the front side.

An internal partitioning ensures the separation from other media in the behind cable chamber. The complete profile can be opened and thus, allows good and easy access to all media.

A specially developed opening mechanism stands for perfect ergonomics. In the front chamber for example, measuring cables can be led through. The rear chamber is suitable for power lines.

Thereby the ideal separation of media has been achieved as regards electromagnetic compatibility. The channel can be fitted to the L-profile at any time. The Expand profile 1 together with the L-profile allows an unequalled adaptability and optimal economic efficiency. In addition, the Expand profile 1 has at its long side two solid grooves for mounting the most different system components.

The profile is so designed that it is guided from the floor through the Connector on the inner surface of the table. Thus, each function level is reached. Here again, the Connector stands the test in form and function.

In training centres the channel can be locked against unauthorised opening. The integration of small devices such as sockets and interface connectors is also possible.

Divided Expand profile 1

The Expand profile 1 can also be divided so that for example the space above the table top can be opened independently of the space below the table top. The Expand profile 1 offers a maximum of functionality as well as an optimal handling.

Expand profile 1		
Profile lengths rear leg incl. leg adjuster	Reference No.*	Notes
702 mm	ELC2.5.0702.x	forward table legs
780 mm	ELC2.5.0780.x	rear table legs
1.200 mm	ELC2.5.1200.x	rear table legs
1.400 mm	ELC2.5.1400.x	rear table legs
1.500 mm	ELC2.5.1500.x	rear table legs
1.800 mm	ELC2.5.1800.x	rear table legs
2.000 mm	ELC2.5.2000.x	rear table legs
2.200 mm	ELC2.5.2200.x	rear table legs

* Note: Please replace the "x" with desired position of installation
L = left, R = right, LR = left and right

Expand profile 2

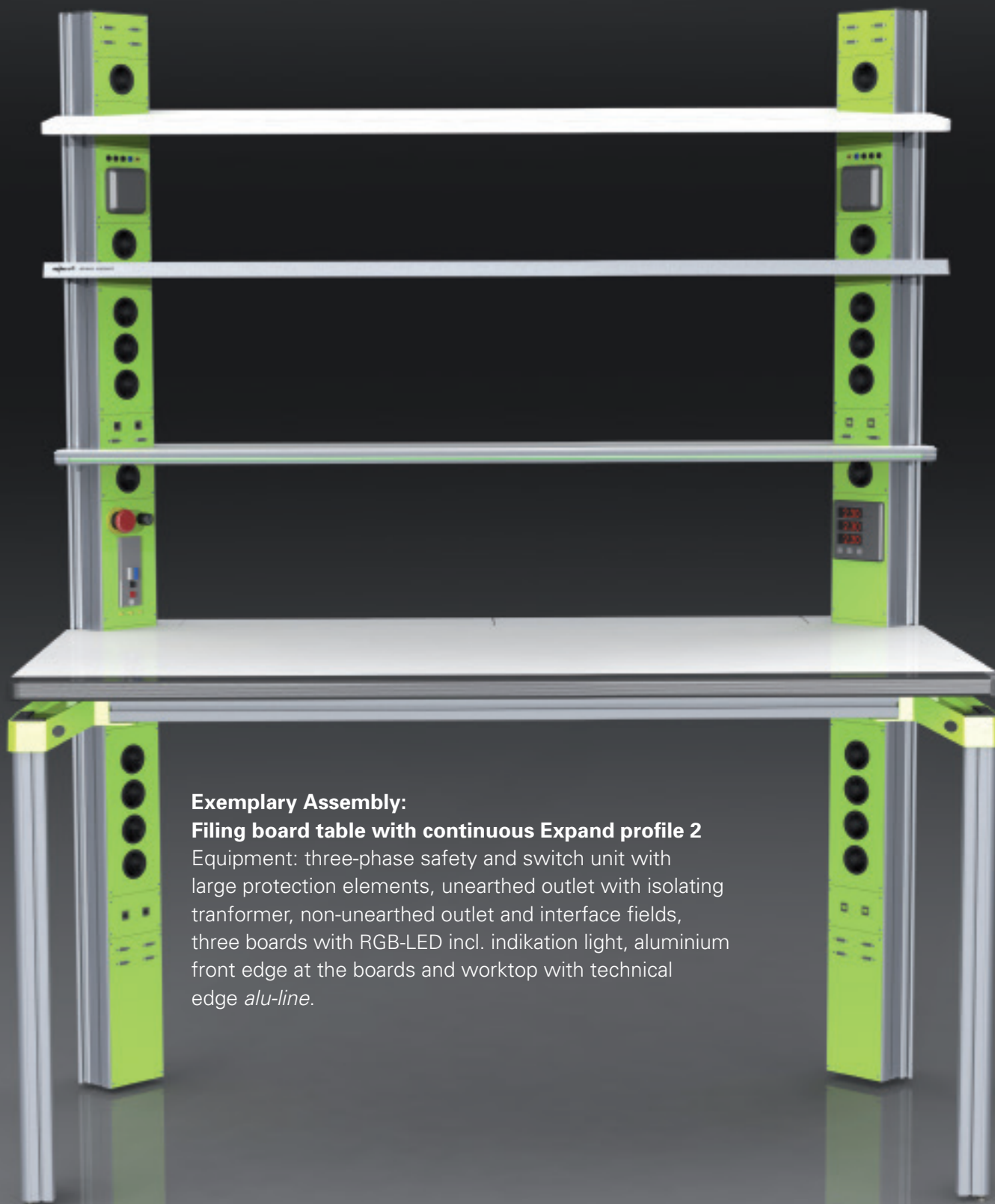

Exemplary Assembly:

Filing board table with continuous Expand profile 2

Equipment: three-phase safety and switch unit with large protection elements, unearthed outlet with isolating transformer, non-earthed outlet and interface fields, three boards with RGB-LED incl. indication light, aluminium front edge at the boards and worktop with technical edge *alu-line*.



The Expand profile 2

This profile is attached to the inner surface of the L-profile and serves for fitting small devices such as socket modules, three-phase supplies or interface areas. The profile accepts also the device programme act and thus, opens up many additional fields of application.

The profile size and configuration has been chosen so that even three-phase elements can be integrated easily and quickly. Due to its configuration the profile can, in addition to the vertical position, be used in horizontal position as well and can be as static carrier section for filing boards and device cockpits. This forms a bridge which due to its horizontal and vertical structure allows an almost unlimited capacity as regards equipment.

The erfi bridge facilitates a modern free wiring from the vertical to the horizontal line. Concurrent an unequalled capacity for fitting equipment is possible which ensures the necessary reserve for future expansions.

Different situations regarding assembly

1. Only vertical, to the inner surface of the L-profile, to the rear L-legs; also for single-sided use;
2. Only horizontal below boards or cockpits, or by itself;
3. Vertical and horizontal, shaped to a bridge, mitre cutting at the edges;

The profile is led upwards from the level of the table top and can be extended below the table down to the floor. Optionally, it can be combined with Expand profile 1 underneath the table top. Thus, large quantities of cables can be placed invisibly. Expand profile 2 is equipped with a groove technique which can accept two cable chambers on the inner surface for shielding. On the outer surface the grooves are arranged that additional swivel arms can be fitted to the outside of the table without colliding with neighbouring tables. The arrangement of the device front panel is chosen so that in vertical as well as in horizontal direction the attachments are inclined towards the user at an angle of 45°.

Expand profile 2				
Profile length	Reference No.	vertical Installation	Capacity below work top	Capacity above work top
360 mm	ELC2.6.0360.x	betw. work top & filing boards, height 1200 mm		79 DU
450 mm	ELC2.6.0450.x	betw. work top & cockpit device 3 HU, height 1400mm		88 DU
410 mm	ELC2.6.0410.x	betw. work top & cockpit device 6 HU, height 1500mm		81 DU
650 mm	ELC2.6.0650.x	rear length of table leg 780 mm	130 DU	
1.200 mm	ELC2.6.1200.x	rear length of table leg 1200 mm	130 DU	82 DU
1.400 mm	ELC2.6.1400.x	rear length of table leg 1400 mm	130 DU	121 DU
1.500 mm	ELC2.6.1500.x	rear length of table leg 1500 mm	130 DU	141 DU
1.800 mm	ELC2.6.1800.x	rear length of table leg 1800 mm	130 DU	200 DU
2.000 mm	ELC2.6.2000.x	rear length of table leg 2000 mm	130 DU	239 DU
2.200 mm	ELC2.6.2200.x	rear length of table leg 2200 mm	130 DU	278 DU

* Note: Please replace the "x" with desired position of installation
L = left, R = right, LR = left and right

The erfi Bridge

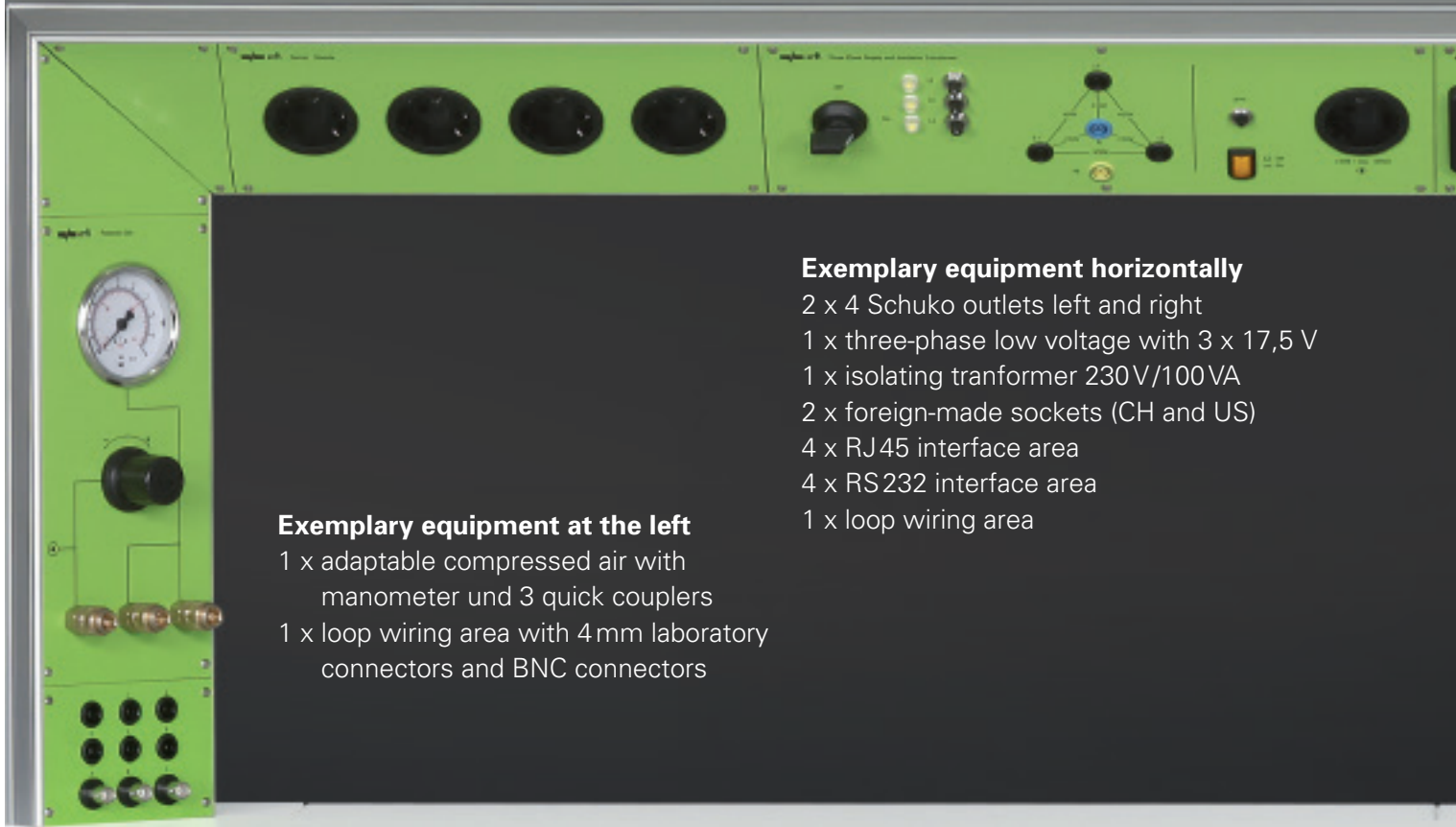

Exemplary equipment at the left

- 1 x adaptable compressed air with manometer und 3 quick couplers
- 1 x loop wiring area with 4mm laboratory connectors and BNC connectors

Exemplary equipment horizontally

- 2 x 4 Schuko outlets left and right
- 1 x three-phase low voltage with 3 x 17,5 V
- 1 x isolating transformer 230V/100VA
- 2 x foreign-made sockets (CH and US)
- 4 x RJ45 interface area
- 4 x RS232 interface area
- 1 x loop wiring area

The erfi Bridge

Expand profile 2 horizontal und vertical

This example is a 3-HU cockpit table to which the Expand profile 2 was ergonomically attached at an angle of 45° as vertical and horizontal surfaces for the equipment. The inside wiring is no problem due to the generous dimensioning also with large cross sections. The illustrated device cockpit contains the new capacitive controlled device series *elneos five*.



Exemplary equipment at the right

- 1 x safety and switch unit
 - three-phase with motor overload switch,
 - all-current sensitive NFI switch,
 - key-operated switch,
 - EMERGENCY STOP tracer,
 - three-phase control display
- 1 x Schuko outlet

Order table for the complete erfi bridge

(Consisting of 2 vertical (left and right) and one horizontal Expand profile 2)

Table length	with Board (height 1200 mm)	BK V/BK H*	with 3 HU cockpit (height 1400 mm)	BK V/BK H*	with 6 HU cockpit (height 1500 mm)	BK V/BK H*
1.200 mm	ELC2.7.1200	2x53/178	ELC2.8.1200	2x62/178	ELC2.9.1200	2x65/178
1.600 mm	ELC2.7.1600	2x53/256	ELC2.8.1600	2x62/256	ELC2.9.1600	2x65/256
1.800 mm	ELC2.7.1800	2x53/295	ELC2.8.1800	2x62/295	ELC2.9.1800	2x65/295
2.000 mm	ELC2.7.2000	2x53/334	ELC2.8.2000	2x62/334	ELC2.9.2000	2x65/334

Additional price for the vertical extension of the bridge down to the floor, Reference No.: ELC2.6.0650 LR
 Optionally, the Expand profile 1 can be used down to the floor, Reference No.: ELC2.5.0780

* BK V = Capacity vertical in DU (depths unit)
 BK H = Capacity horizontal in DU (depths unit) 1 DU = 5,08 mm

elneos connect – the lifetime experience

Electric height adjustment



The electric height adjustment

The development of *elneos connect* incorporates our experience of many years in the field of height adjustable working places. Based on this knowledge, we have developed a completely new lift system.

As centrepiece *elneos connect* has a compact height adjusting system which offers also a maximum of stability and load bearing capacity. A newly developed telescopic leg which contains the L-profile, guarantees a stability which has never been reached before. The telescopic leg has additional grooves, allowing optimal connections in the lower table area.

When developing *elneos connect*, great importance has been attached to a covered media guidance during the height adjusting process. The Expand profile 1 inside the L-profile moves together with the L-profile and thus, ensures an optimal and invisible cable guiding. The media guided in the L-profile are also invisible during height adjustment.

Technical data of the electric drive

Stroke: 300 mm from 780 mm to 1080 mm
400 mm from 780 mm to 1180 mm (alt.)
500 mm from 780 mm to 1280 mm (alt.)

Lifting force: 350 kg, alternatively 600 kg

Lifting speed: approx. 15 mm/s

Height adjustment at the push of a button inclusive digital height indication in cm as well as a memory function for storing 3 positions (cm display).

Mains connection: 230V/110VAC

EMV: very low electromagnetic radiation, particularly suited for the use with PC workstations or in the field of electronics and electrotechnology.

Unrivalled technique of the system

The lifting technique is invisibly incorporated in the L-profile without wasting valuable space for cables. During lifting the complete working place is lifted to the desired height. Of course, as with the previous systems the suspended drawer units move to the same height.

Special features

1. No waste of space for cables

The height adjustment has been so developed that the space for cables inside the L-profile is not affected. The function of the L-profile and the media guidance are not impaired in any way.

2. High stability and high adjustment

Due to the new telescopic leg, the outer telescopic profiles include the L-profile and provides outstanding stability. The new construction also allows the installation of the new hydraulic compact cylinders which offer a lifting length of up to 500 mm. A lifting strength of up to 600 kg and the lifting length of 500 mm are advantages, which only can be reached with the telescope technology by *erfi*.

3. Optimal usability by integrated grooves

The telescopic profile is a special aluminium extrusion profile with integrated functional grooves. All thinkable system components can be mounted to this telescopic profile without having to follow the lifting movement. If the system components are to follow the lifting movement, they can be connected directly to the displaceable L-profile.

4. Optimal media guidance and protection

With *elneos connect* all media are serially always covered and are also guided during lifting by the telescopic profiles. Even large quantities of cables are covered at all sides during lifting by the Expand profile 1 and are protected against any outside influences.

5. Extendable and flexible without alteration works

The Expand profile 1 can be retrofitted at any time, also to height adjustable tables. The telescopic profile includes the L-profile so that the inner surface allows the later fitting of the Expand profile 1.

6. Retrofit

The new height adjusting system has been so developed that it can be incorporated in existing *elneos connect* tables.

Height adjustment system		
Stroke	350 kg	600 kg
300	ELC5.300.350	ELC5.300.600
400	ELC5.400.350	ELC5.400.600
500	ELC5.500.350	ELC5.500.600

elneos connect – the lifetime experience

Drawer unit programme



The *elneos connect* drawer unit programme

The main advantages of the drawer unit programme *elneos connect* over other drawer unit systems are as follows:

1. Touch-to-open technique, serially installed;
2. Special travelling mechanism ensuring a high stability;
3. Mobile pedestal can be transformed into a suspended drawer unit at any time;
4. High-quality rollers of 75 mm diameter with highly improved running characteristics;
5. Material tray with improved compartmentation and usable height (usable height 40 mm).

Characteristics

1. Touch-to-open technique

Automatic opening mechanism is now a standard! Touch-to-open needs only a slight pressure on the front and the drawer opens. A technique which meets the requirements of *elneos connect*. After opening it is up to you how far the drawer should open. Touch-to-open replaces handles on drawer units and lateral handle bars. The facings are smooth on all sides and thus, offer a maximum of safety! Also lateral handle bars are not required any more with this new technique. Even when the drawers are ajar, the risk of injury is minimized because there are no projecting lateral edges or corners.

2. Smart-Close technique

As an alternative to the Touch-to-open technique, *elneos connect* now offers the Smart-Close technique! When closing the drawer it is slowed down on the last few centimetres and slides smoothly in the final position without jerk.

3. Electronic central locking as an option

On request, the drawer units are also deliverable with an electronic central locking (transponder).

4. Mobile pedestals with serially installed special travelling mechanism

To meet special requirements in classrooms or in tough industrial environments, *elneos connect* mobile pedestals are serially equipped with a reinforced travelling mechanism made of metal. This avoids safely the tearing off of the rollers!

Technical design

- All models are optionally of conductive design.
- Corpus made of directly laminated fine chipboard with a noble look and low noise emission.
- Equipped with steel drawers which allow easy organisation.
- Topmost pullout serially equipped with an especially high insert for writing utensils (40 mm) and clearly improved compartmentation; height of front panel 1 HE (HU = height unit, 1 HU = 50 mm);
- Height of drawer front panel from 2 HU to 6 HU;
- Suspended drawer unit mountable at any position of the aluminium table frame;
- All suspended drawer units are equipped with a Stop-Control function (always one drawer only can be pulled out).
- All mobile pedestals have the Stop-Control-Plus function. This function ensures that only one drawer opens when passing over thresholds or the like. The locking of the drawers cannot be outwitted. This avoids an unintended tilting over.
- Drawers with a front panel of a height of 6 HU are serially equipped with a drawer runner.
- Usable depth of the drawers 490 mm, alternatively 690 mm;
- High-quality drawer runner, quadruple ball-bearing runners, deliverable for each drawer inclusive self-cleaning function for a long durability;

Versatile versions

- Mobile pedestals, system width 430 mm
- Mobile pedestals, system width 330 mm
- Suspended drawer units, system width 430 mm
- Suspended drawer units, system width 330 mm
- Stand-alone drawer units, system width 430 mm
- Stand-alone drawer units, system width 330 mm
- 19" under desk cabinets
- PC under desk cabinets

Mobile pedestals



The essential advantages

- Touch-to-open
- Special travelling mechanism and 75 mm design rollers with excellent running characteristics
- Convertible to suspended drawer units
- Improved material tray
- One-piece top panel

Please replace the "x" in the reference no. by the desired decor of the drawer unit.

Decor 1 Non conductive decor

Front panels: front white

Corpus: graphite black

Decor 2 Non conductive decor

Front panels: front white

Corpus: front white

Decor 3 ESD design

Front panels: front white

Corpus: front white

Rollers: ESD design

Mobile pedestals

Depth	Width	Usable drawer depth	Design A drawer division: 1 x 1 HU, 3 x 3 HU	Design B drawer division: 1 x 1 HU, 1 x 2 HU, 1 x 3 HU, 1 x 4 HU	Design C drawer division: 1 x 1 HU, 3 x 2 HU, 1 x 3 HU	Design D drawer division: 1 x 1 HU, 1 x 3 HU, 1 x 6 HU
577 mm	430 mm	490 mm	ELC6.1.544.A.x	ELC6.1.544.B.x	ELC6.1.544.C.x	ELC6.1.544.D.x
577 mm	330 mm	490 mm	ELC6.1.534.A.x	ELC6.1.534.B.x	ELC6.1.534.C.x	ELC6.1.534.D.x
777 mm	430 mm	490 mm	ELC6.1.744.A.x	ELC6.1.744.B.x	ELC6.1.744.C.x	ELC6.1.744.D.x
777 mm	430 mm	690 mm	ELC6.1.746.A.x	ELC6.1.746.B.x	ELC6.1.746.C.x	ELC6.1.746.D.x
777 mm	330 mm	490 mm	ELC6.1.734.A.x	ELC6.1.734.B.x	ELC6.1.734.C.x	ELC6.1.734.D.x
777 mm	330 mm	690 mm	ELC6.1.736.A.x	ELC6.1.736.B.x	ELC6.1.736.C.x	ELC6.1.736.D.x

Note

Drawer unit height: 610 mm (incl. rollers) drawer compartmentation indicated in HU. 1 HU = 44,45 mm, topmost pullout serially equipped with an extra deep insert for the writing utensils!



Options	
drawer base unit for usable drawer depth 490 mm	ELC6.9.1
drawer base unit for usable drawer depth 690 mm	ELC6.9.2
Smart-Close instead of Touch-to-open	ELC6.9.3
electronic central locking	ELC6.9.4

Suspended drawer units



The essential advantages

- Touch-to-open
- Transformable into mobile pedestals
- Improved material tray
- Mountable to any position of the frame

Please replace the "x" in the reference no. by the desired decor of the drawer unit.

Decor 1 Non conductive decor

Front panels: front white

Corpus: graphite black

Decor 2 Non conductive decor

Front panels: front white

Corpus: front white

Decor 3 ESD design

Front panels: front white

Corpus: front white

Suspended drawer units

Depth	Width	Usable drawer depth	Design A drawer division: 1 x 1 HU, 3 x 3 HU	Design B drawer division: 1 x 1 HU, 1 x 2 HU, 1 x 3 HU, 1 x 4 HU	Design C drawer division: 1 x 1 HU, 3 x 2 HU, 1 x 3 HU	Design D drawer division: 1 x 1 HU, 1 x 3 HU, 1 x 6 HU
577 mm	430 mm	490 mm	ELC6.2.544.A.x	ELC6.2.544.B.x	ELC6.2.544.C.x	ELC6.2.544.D.x
577 mm	330 mm	490 mm	ELC6.2.534.A.x	ELC6.2.534.B.x	ELC6.2.534.C.x	ELC6.2.534.D.x
777 mm	430 mm	490 mm	ELC6.2.744.A.x	ELC6.2.744.B.x	ELC6.2.744.C.x	ELC6.2.744.D.x
777 mm	430 mm	690 mm	ELC6.2.746.A.x	ELC6.2.746.B.x	ELC6.2.746.C.x	ELC6.2.746.D.x
777 mm	330 mm	490 mm	ELC6.2.734.A.x	ELC6.2.734.B.x	ELC6.2.734.C.x	ELC6.2.734.D.x
777 mm	330 mm	690 mm	ELC6.2.736.A.x	ELC6.2.736.B.x	ELC6.2.736.C.x	ELC6.2.736.D.x

Note

Drawer unit height: 527 mm
drawer compartmentation indicated in HU.

1 HU = 44,45 mm, topmost pullout serially equipped with an extra deep insert for writing utensils!



Options

drawer base unit for usable drawer depth 490 mm	ELC6.9.1
drawer base unit for usable drawer depth 690 mm	ELC6.9.2
Smart-Close instead of Touch-to-open	ELC6.9.3
electronic central locking	ELC6.9.4

Pedestals



The essential advantages

- Touch-to-open
- Transformable into big mobile pedestals
- Improved material tray
- Mountable to any position of the frame

Please replace the "x" in the reference no. by the desired decor of the drawer unit.

Decor 1 Non conductive decor

Front panels: front white

Corpus: graphite black

Decor 2 Non conductive decor

Front panels: front white

Corpus: front white

Decor 3 ESD design

Front panels: front white

Corpus: front white

Pedestals

Depth	Width	Usable drawer depth	Design A drawer division: 1 x 1 HU, 3 x 3 HU	Design B drawer division: 1 x 1 HU, 1 x 2 HU, 1 x 3 HU, 1 x 4 HU	Design C drawer division: 1 x 1 HU, 3 x 2 HU, 1 x 3 HU	Design D drawer division: 1 x 1 HU, 1 x 3 HU, 1 x 6 HU
577 mm	430 mm	490 mm	ELC6.3.544.A.x	ELC6.3.544.B.x	ELC6.3.544.C.x	ELC6.3.544.D.x
577 mm	330 mm	490 mm	ELC6.3.534.A.x	ELC6.3.534.B.x	ELC6.3.534.C.x	ELC6.3.534.D.x
777 mm	430 mm	490 mm	ELC6.3.744.A.x	ELC6.3.744.B.x	ELC6.3.744.C.x	ELC6.3.744.D.x
777 mm	430 mm	690 mm	ELC6.3.746.A.x	ELC6.3.746.B.x	ELC6.3.746.C.x	ELC6.3.746.D.x
777 mm	330 mm	490 mm	ELC6.3.734.A.x	ELC6.3.734.B.x	ELC6.3.734.C.x	ELC6.3.734.D.x
777 mm	330 mm	690 mm	ELC6.3.736.A.x	ELC6.3.736.B.x	ELC6.3.736.C.x	ELC6.3.736.D.x

Note

Drawer unit height: 674 mm
 drawer compartmentation indicated in HU.
 1 HU = 44,45 mm, topmost pullout serially equipped with an extra deep insert for the writing utensils!



Options	
drawer base unit for usable drawer depth 490 mm	ELC6.9.1
drawer base unit for usable drawer depth 690 mm	ELC6.9.2
Smart-Close instead of Touch-to-open	ELC6.9.3
electronic central locking	ELC6.9.4

19" cabinets and PC under desk cabinets



Please replace the "x" in the reference no. by the desired decor of the drawer unit.

Decor 1 *Non conductive decor*

Corpus: graphite black

Decor 2 *Non conductive decor*

Corpus: front white

Decor 3 *ESD design*

Corpus: front white

19" cabinet			PC cabinet		
Depth	Width	Design	Depth	Width	Design
577 mm	525 mm	ELC6.4.550.A.x	577 mm	270 mm	ELC6.5.520.A.x
777 mm	525 mm	ELC6.4.750.A.x	777 mm	270 mm	ELC6.5.720.A.x

PC tray
variable in width 166-256 x 500 x 70 mm (width x depth x height); mountable at left or right-hand side;

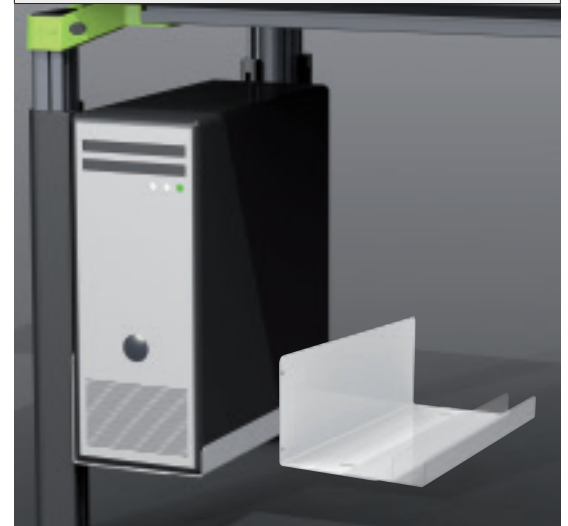

Options 19" cabinet (height: 674 mm)

closed front cover for 19" cabinet incl. lock and handle

ELC6.9.5

glas front cover for 19" cabinet incl. lock and handle

ELC6.9.6

Options PC cabinet (height: 674 mm)

closed front cover for PC cabinet incl. lock

ELC6.9.7

glas front cover for PC cabinet incl. lock

ELC6.9.8

Organiser elements for steel drawers



Form filing sets

Angle adjustable; black plastics; for cleanly filing DIN A4 pages);

Frames for suspension files

Nickel-plated steel, black plastics; for suspending DIN A4 suspension folders and files
 - Height of drawer front panel 7 HU
 - Inclusive intermediate division bars (1 with a usable drawer depth of 490 mm) (2 with a usable drawer depth of 690 mm)

Flexible material tray

Black plastics; for placing in steel drawers;



Stamp holder

Steel, powder-coated, black; for 8 stamps and dater stamp

Formular filing set		
Design	Size	Ref. No.
formular filing set 6-fold consisting of: - 6 formular filing set - 4 separating bars	for drawers with drawer depth 327 mm, drawer depth 490 bzw. 690 mm and container width 430 mm	ELC6.8.301
formular filing set 11-fold consisting of: - 11 formular filing set - 8 separating bars	for drawers with drawer depth 327 mm, drawer depth 690 mm and container width 430 mm	ELC6.8.302

Einsteckhängerahmen		
Size	Depth	Reference No.
for drawer depth 327 mm and container width 430 mm	490 mm	ELC6.8.305
	690 mm	ELC6.8.306

Flexible material tray/Stamp holder	
Size	Reference No.
327 x 110 x 30 mm container width 430 mm	ELC6.8.307
	ELC6.8.309

Separating bars				
	Separating bars double-walled with lateral notches for the safe catch in the side panel	Design	Size	Reference No.
				steel powder-coated black
		plastics black	327 x 10 x 76 mm	ELC6.8.103
	Compartment divider	steel powder-coated black	A4 = 310 x 1 x 72 mm	ELC6.8.104
			A5 = 220 x 1 x 72 mm	ELC6.8.105
			A6 = 150 x 1 x 72 mm	ELC6.8.107
			A7 = 110 x 1 x 72 mm	ELC6.8.106
	Tags (2 pcs, necessary) with lateral notches for the safe catch in the lateral panel	steel powder-coated black	327 x 65 x 78 mm	ELC6.8.202
	Pendulum plate to be inserted in 2 tags	steel powder-coated black	A4 cross = 317 x 1 x 210 mm	ELC6.8.203
			A5 cross = 227 x 1 x 148 mm	ELC6.8.204
			A6 cross = 167 x 1 x 105 mm	ELC6.8.205

Drawer inserts

Plastic drawer inserts serve for the orderly keeping of small items and tools. Suitable for a usable drawer depth of 490 mm there are 6 inserts and 1 complementary insert for the usable drawer depth of 690 mm.



Ordering example
with reference no.
ELC6.8.403

Drawer inserts				
	Design	Container width	Size	Reference No.
	drawer inserts - with 3 compartments - for tools	430 mm	327 x 490 x 40 mm	ELC6.8.401
	drawer inserts - with 4 compartments - for tools	430 mm	327 x 490 x 40 mm	ELC6.8.402
	drawer inserts - with 6 compartments - for tools	430 mm	327 x 490 x 40 mm	ELC6.8.403
	drawer inserts - with 8 compartments - for tools	430 mm	327 x 490 x 40 mm	ELC6.8.404
	drawer inserts - 2-part - with total 30 compartments - for small parts	430 mm	327 x 490 x 40 mm	ELC6.8.405
	drawer inserts - 2-part - with total 25 compartments - for small parts	430 mm	327 x 490 x 40 mm	ELC6.8.406
	expanding insert for usable drawer units 690 mm - with 3 compartments	430 mm	327 x 200 x 40 mm	ELC6.8.407

Stichwortverzeichnis *elneos connect*

19" cockpit 44-47, 70-71

19" drawer unit 85

19" table attachments 68-69

alu-line technical edge 40-41, 55, 57

Aluminium functional profile Top 62, 44, 47

Aluminium functional profile Toplight 44, 47, 63

Aluminium table frames 38, 39

Basic tables 6-7, 54-57

Basic tables with cable flap 55-57

Basic tables with foldaway cable flap 56

Cable guidance 28, 29, 72-73

Cable tray 55-57

Clip profile 28, 29, 72-73

Cockpit 44-47, 70-71

Cockpit table 44-47, 70-71

Connector 18-23

Continuous media guidance 24-25

Decor 54, 82-85

Drawer unit programme 52-53, 80-85

Electroconductive table tops 54-57

Electronic central locking 81-84

Electronic laboratory tables 6-15

elneos five device system 9-15, 44-45

erfi bridge 32-35, 76-77

ergo-line work top 42-43, 54-57

ESD design 54-57, 61, 82-85

ESD table 54-57

Expand profile 1 28-30, 72-73

Expand profile 2 30-35, 74-77

Filing board inclined 61

Filing board straight 61

Filing board tables 61

Foldaway cable flap 56

Functional profiles for filing boards and cockpit 62-63

Height adjustable tables 36-37, 78-79

Height adjustment 36-37, 78-79

High-performance LED lamps 47-51, 64-67

Inclinable filing boards 61

Indication lamp 44-45, 66-67

Laboratory tables 6-15

LED lamps 48-51, 64-65

LED working place lamps 48-51, 64-65

Lighting 48-51, 64-65

Lowerable cable flap 56

Lowered supply terminal 57

L-profile 58-59

Modular tables 58-59

Motor driven height adjustable tables 36-37, 78-79

Organiser elements for steel drawers 86-87

PC drawer unit 85

PC tray 85

Postforming table top 55, 57

RGB indication lamp 44-45, 66-67

RGB lamp 44-45, 66-67

RGB-LED swivelling lamp 48-51, 64-65

Sensor controlled LED lamp 48-51, 64-65

Smart-Close technique 81-84

Stand-alone drawer units 84

Supply terminal 57

Suspended drawer units 52-53, 80-85

Swivelling lamps LED 48-51, 64-65

Table attachments 68-69

Technical edge alu-line 40-41, 54-57

Telescopic profile 36-37

Top aluminium functional profile 44, 47, 62

Toplight aluminium functional profile 44, 47, 63

Touch-to-open technique 52, 81-84

Product design – erfi design team:

David Köhler
Prof. Gerd Flohr

Marketing campaign and visual design:

Prof. Petra Müller

Subject to technical and formal alterations.
HD-0813-M04



erfi Ernst Fischer GmbH + Co.KG
Alte Poststrasse 8
72250 Freudenstadt • Germany
Phone +49 (0) 7441 91 44-0
Telefax +49 (0) 7441 91 44-477
erfi@erfi.de • www.erfi.de

